

BevMAX MEDIA2 R290

Parts Manual

Model No. - 5800-6HC / 3800-6HC

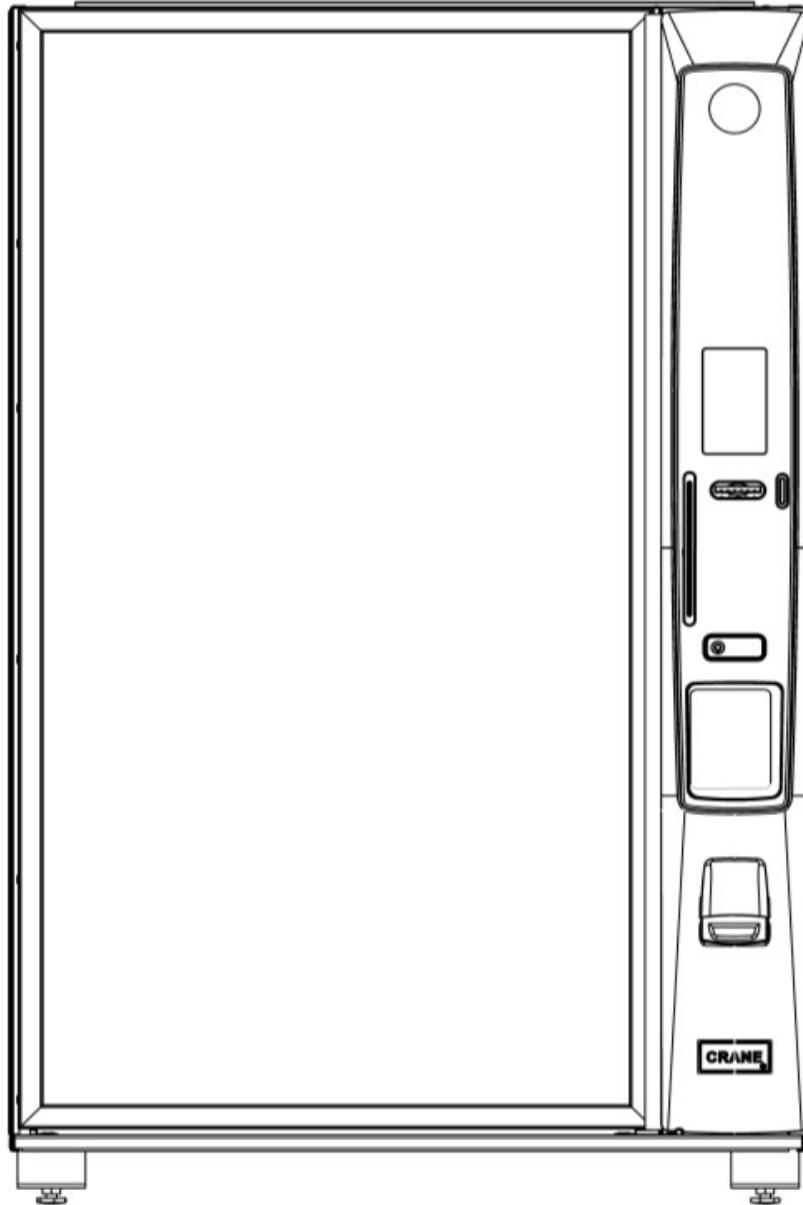

CRANE

CRANE[®] MERCHANDISING SYSTEMS

INDEX

Title	Page No.
Machine Front View.....	2
Cabinet Detail Product Views	4
Cabinet Detail Service Door Area.....	6
XY Motor Picker Unit.....	8
Delivery (Picker) Cup Assembly.....	10
Service Door Area (A)/(B).....	12
Service Door Pills.....	17
Gate Tray Detail.....	18
AC Distribution Box.....	20
Lighting LED.....	21
Refrigeration Unit.....	22
Electronics.....	23
Harness.....	24
Screws.....	28
Nuts Washers.....	30
Bolts Rivets.....	31
Clips and Pins Miscellaneous.....	32
Wire Clamp.....	33

Machine Front View

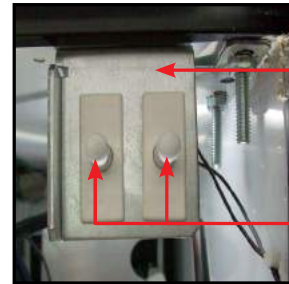
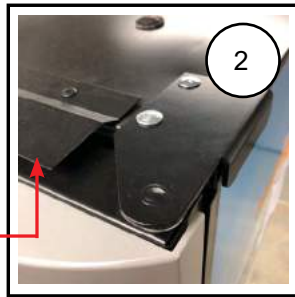

Standard For E-Lock

20

7

6



5

4

3



8

9

11

10

Standard For T-Handle

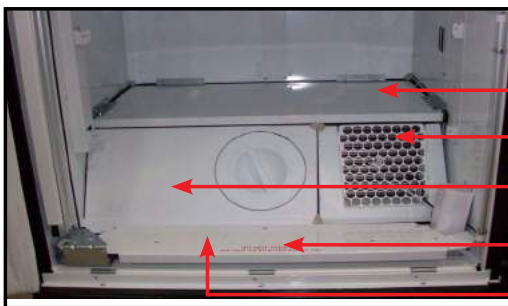

12

13

14

15

16

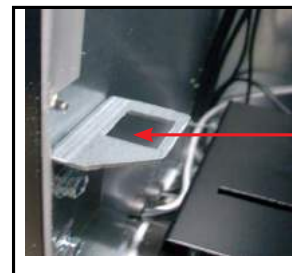

17



18



19

Machine Front View

ITEM REF	PART DESCRIPTION	Wide 5800-6HC	Narrow 3800-6HC
1	Top Hinge Glass Door	100136	
2	Top Hinge Service Door	104555	
3	Door Assembly, Glass - Silver (does not include decals)	101450	101451
	Door Assembly, Glass – Black (does not include decals)	101452	105811
4	Gasket, Glass Door	102720	102721
5	Wear Strip Door Decal - Clear	102359	
6	Door Switch - Left	101188	
	Power Interrupt Switch - Right		
7	Door Switch Bracket – Double Switch	104768	
8	Service Door Switch Bracket Assy. T-HANDLE <i>applicable to venders serialized 111904030102 and later</i>	400349	
9	Door Switch - Left T-HANDLE	400477	
	Power Interrupt Switch – Right T-HANDLE		
10	Switch Lock Bracket T-HANDLE	400350	
11	Door Switch Engagement Plate	400448	
12	Bottom Panel Assembly	104580	104594
13	Evaporator Inlet Grill, Plastic	102854	
14	Assembly Panel Slanted w/ Clean Out	104831	104832
15	Warning Label, Ramp	102159	
16	Ramp	104810	104809
17	Door Latch High Security, 2 Point Lock	104691	
18	Shipping Boards, Domestic and Export	103038	
19	Leg Leveler, 5/8 – 11 x 2 1/16	101288	
20	Top Vandal Panel	104801	104806

Parts not shown/ Cannot be seen.

Part numbers and descriptions subject to change without notice.

NA = Not applicable TBD = To be determined RB = Replaced by

Cabinet Detail Product Views

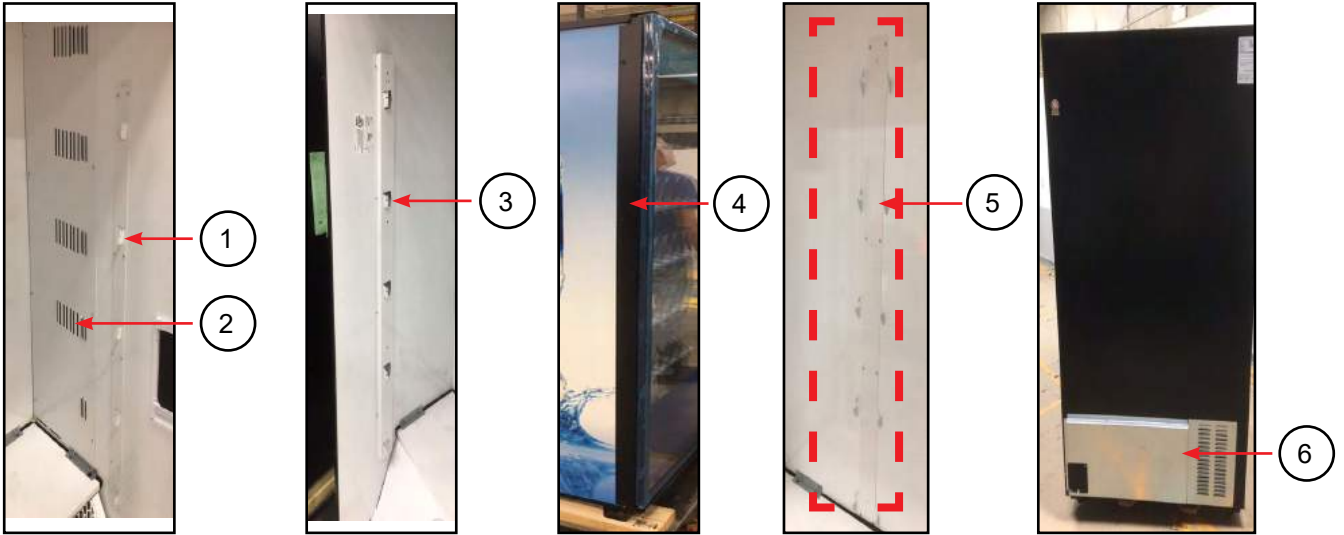

Cabinet Detail Product Views

ITEM REF	PART DESCRIPTION	Wide	Narrow
		5800-6HC	3800-6HC
1	Right Tray Support, 1 piece (5 shelf) - E3 (Rail)	104643	
	Right Tray Support, 1 piece (5 shelf) - E4 (Rail)	104647	
	Right Tray Support, 1 piece (5 shelf) - E5 (Rail)	104653	
	Right Tray Support, 1 piece (5 shelf) - E6 (Rail)	104665	
	Right Tray Support, 1 piece (5 shelf) - D2 (Rail)	104614	
	Right Tray Support, 1 piece (5 shelf) - D8 (Rail)	104812	
2	Louver Panel Assembly (Not Shown)	110349	
3	Left Tray Support, 1 piece (5 shelf) - E3 (Rail)	104644	
	Left Tray Support, 1 piece (5 shelf) - E4 (Rail)	104646	
	Left Tray Support, 1 piece (5 shelf) - E5 (Rail)	104652	
	Left Tray Support, 1 piece (5 shelf) - E6 (Rail)	104666	
	Left Tray Support, 1 piece (5 shelf) - D2 (Rail)	104613	
	Left Tray Support, 1 piece (5 shelf) - D8 (Rail)	104811	
4	Left Glass Door Vandal Panel	104802	
5	Rear Tray Support, 1 piece (5 shelf) - E3 (Rail)	104645	
	Rear Tray Support, 1 piece (5 shelf) - E4 (Rail)	104648	
	Rear Tray Support, 1 piece (5 shelf) - E5 (Rail)	104654	
	Rear Tray Support, 1 piece (5 shelf) - E6 (Rail)	104667	
	Rear Tray Support, 1 piece (5 shelf) - D2 (Rail)	104615	
	Rear Tray Support, 1 piece (5 shelf) - D8 (Rail)	104813	
6	Ingress Guard	104800	
7	Assembly Discharge Frame Insulated	101431	
8	Discharge Port Diverter Kit	114937	
9	Defrost Control Cover	115162	
10	Security Angle Right	104539	

Parts not shown/ Can not be seen

Part numbers and descriptions subject to change without notice.

NA = Not applicable TBD = To be determined RB = Replaced by

Cabinet Detail Service Door Area

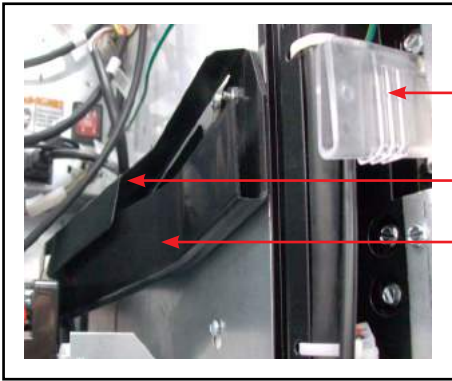

- 4
- 2
- 1

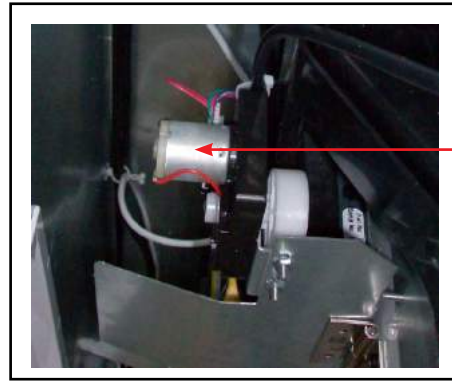

- 3



- 5



- 6
- 7
- 8
- 9
- 10



- 12

Cabinet Detail Service Door Area

ITEM REF	PART DESCRIPTION	Wide 5800-6HC	Narrow 3800-6HC
1	Upper Chute		101396
2	Cover, Upper Coin Insert Chute (Service Part only)		104846
3	Coin Mech Electronic Return Assembly		110626
4	Coin Insert Ramp (on Service Door)		102873
5	Coin Mech Door Assembly with Double roller Latch		104861
6	Kit, Coin Chute Assy		115464
7	Assy. Modified Coin Box Chute		104656
8	Cash Box Shelf – Cover (Service Part only)		104650
9	Door Stop		105405
10	Cash Box, Plastic		101420
11	Locking Cash Box Kit (Service Part only)		400554
12	Cash Box Alignment Shield (started serial number 111911250145)		401647

Parts not shown/ Cannot be seen.

Part numbers and descriptions subject to change without notice.

NA = Not applicable TBD = To be determined RB = Replaced by

XY Motor Picker Unit

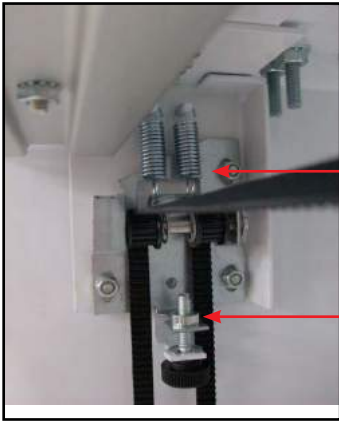

8

9



13



12



17

15

4

6

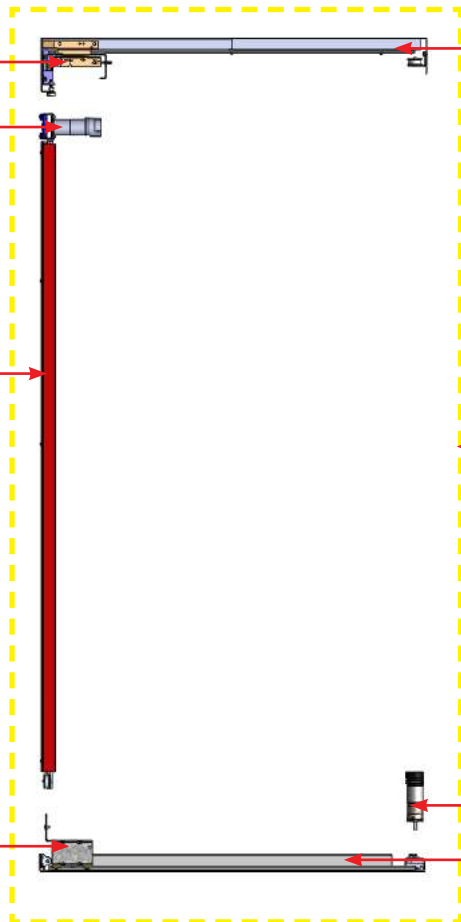

2

1

15

3



14



11

XY Motor Picker Unit			
ITEM REF	PART DESCRIPTION	Wide 5800-6HC	Narrow 3800-6HC
1	XY Delivery System	111293	111291
2	X Axis Mounting Assembly Top	111388	111292
3	Assembly X Axis Drive, Bottom	105491	104566
4	Assembly Y	104869	
5	X Top Carriage Assembly (top of XY)	104551	
6	X Bottom Carriage Assembly (bottom of XY)	105504	
7	Y Carriage Assembly	105503	
8	XY Belt Idler Tensioning Assembly (top left)	105492	
9	X Axis Belt - Kit comes with 2 Belts	401904	
10	Y Axis Belt - Kit comes with 4 Belts	401905	
11	X Drive Pulley Assembly	104636	
12	Y Pulley Drive Assembly	104634	
13	Y Motor Cover Top	101728	
14	X Motor Cover Bottom	101727	
15	Motor XY, Planetary R290 (Brushless)	101102	
16	Y Motor Board (view Electronics pg.)	100639	
17	Assembly Cover Y Belt, Modified	104770	
18	X Home Micro Switch with Straight Arm	101226	
19	X Bottom Belt Cover (Ramp) (View on Machine Front View)	104810	104809

Parts not shown/ Can not be seen

Part numbers and descriptions subject to change without notice.

NA = Not applicable TBD = To be determined RB = Replaced by

Delivery (Picker) Cup Assembly

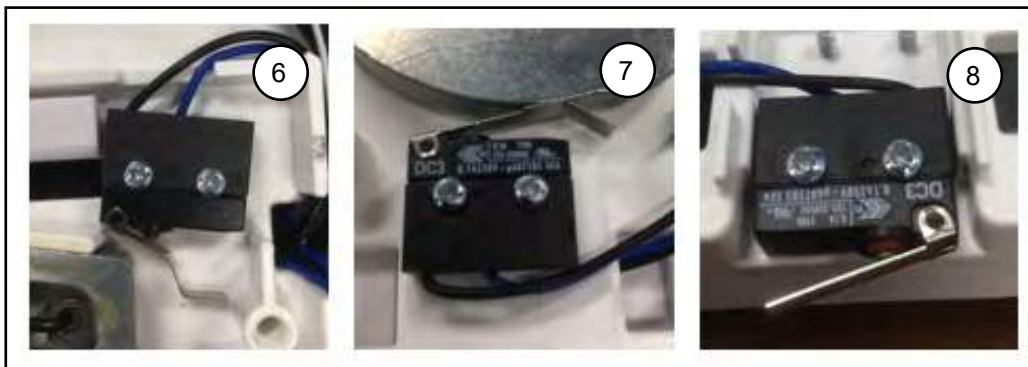
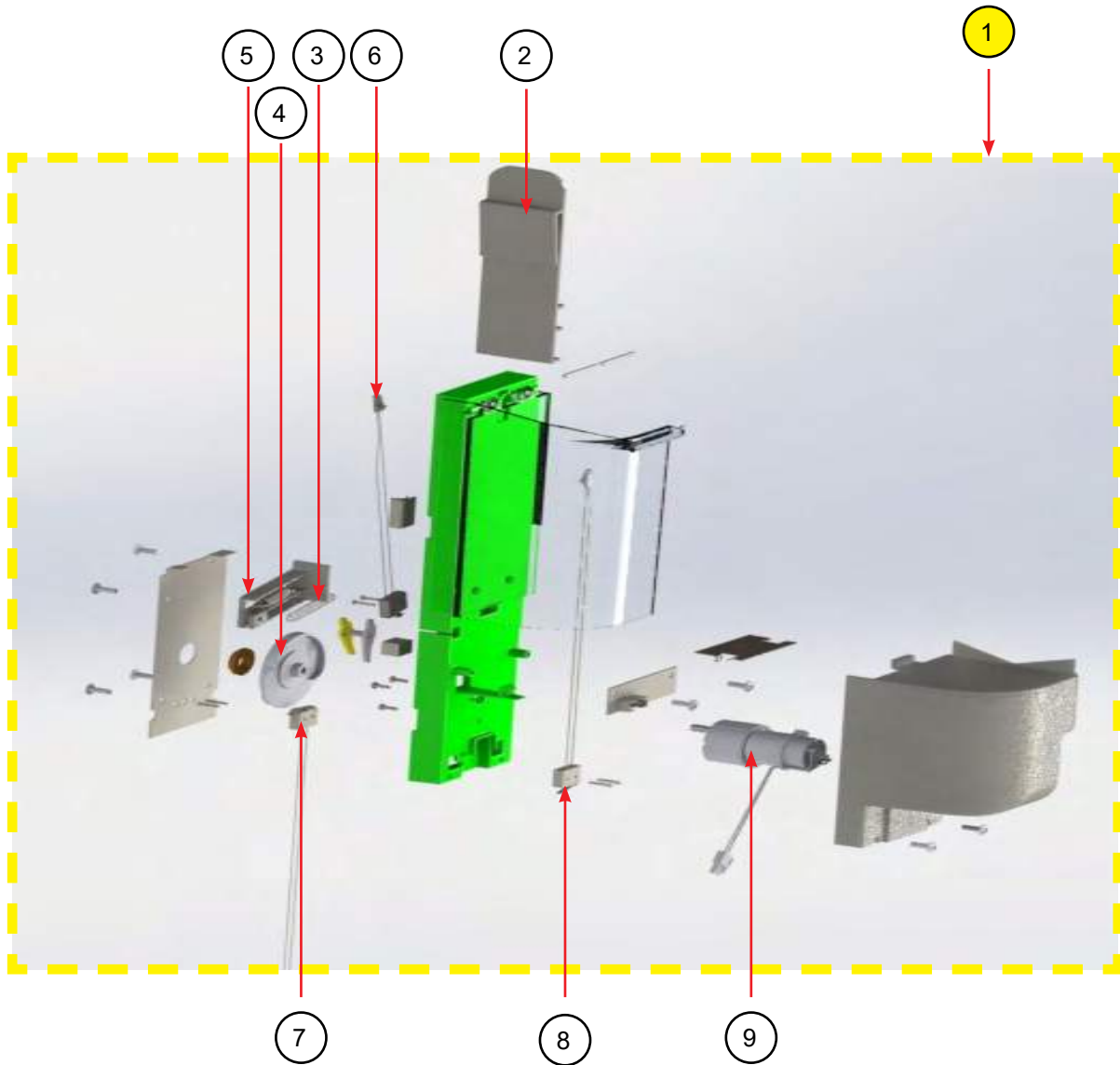

Delivery (Picker) Cup Assembly

ITEM REF	PART DESCRIPTION	Wide	Narrow
		5800-6HC	3800-6HC
1	Assembly Delivery (Picker) Cup Brushless Motor	101730	
2	Cup Deflector - Clear	101737	
3	Return Spring, Plunger (Picker Cup)	100411	
4	Cup Motor Cam	101702	
5	Assembly Extended Plunger	101810	
6	Micro Switch with Bent Arm (Picker Home Switch)	101227	
7	Micro Switch with Bent Arm (Picker Out Switch)	101209	
8	Micro Switch with Straight Arm (Cup Home Switch – Y)	101208	
9	Cup Motor Assembly R 290 Brushless	400634	

Parts not shown/ Cannot be seen.

Part numbers and descriptions subject to change without notice.

NA = Not applicable TBD = To be determined RB = Replaced by

Service Door Area (A)

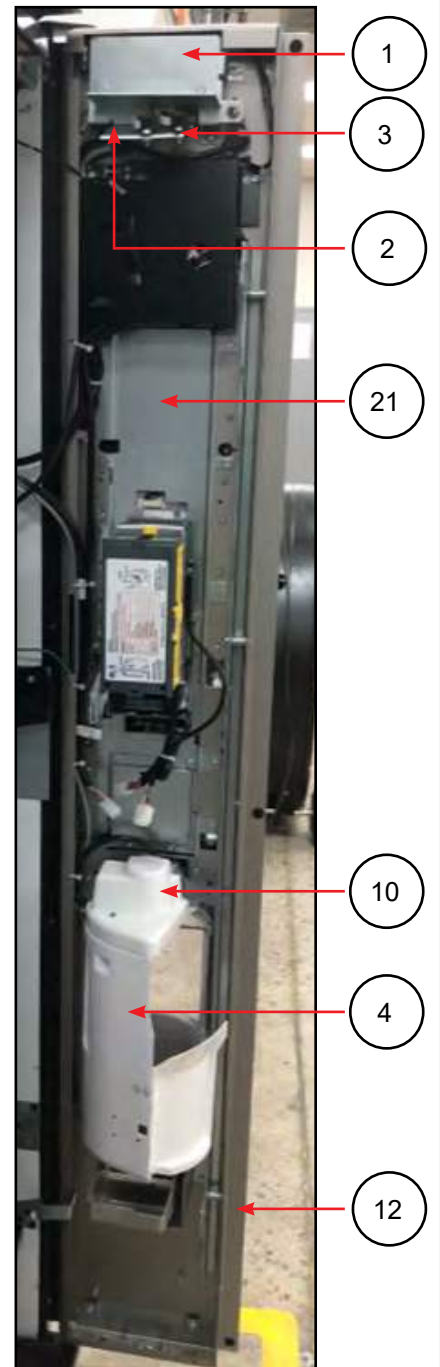
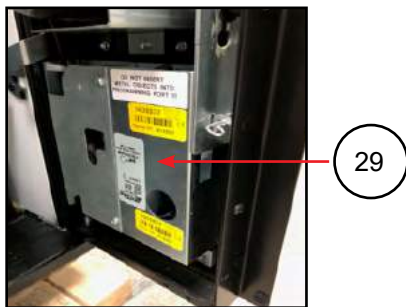
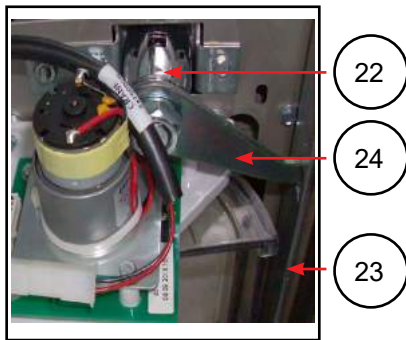
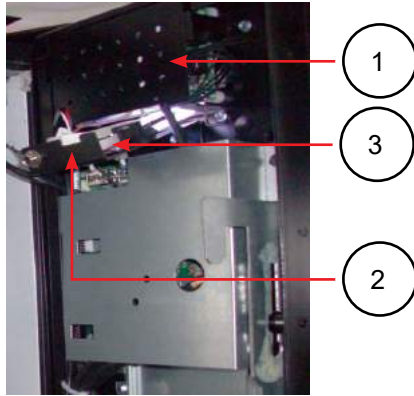
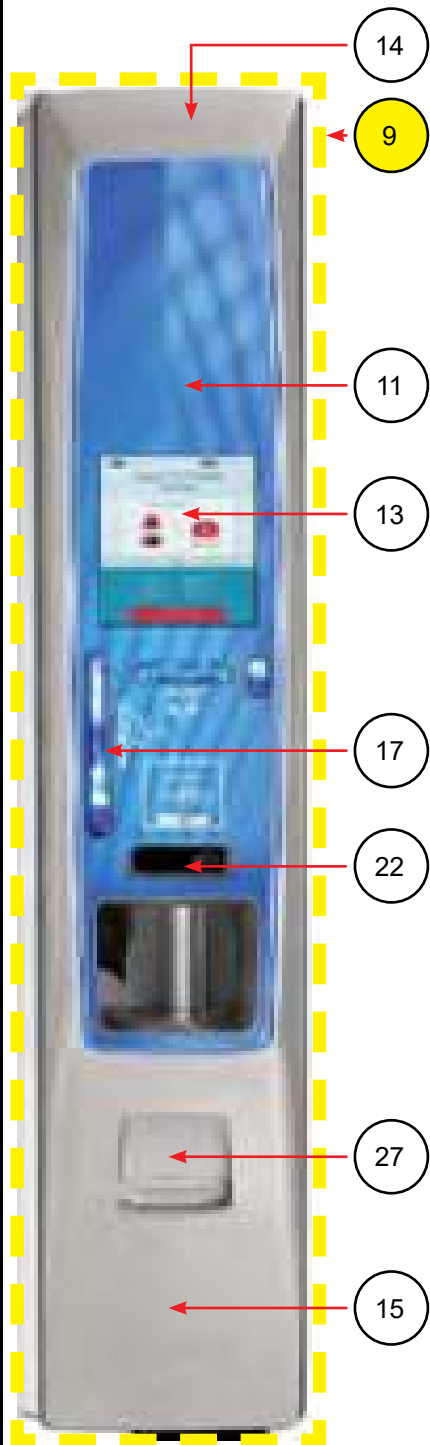

Service Door Area (B)

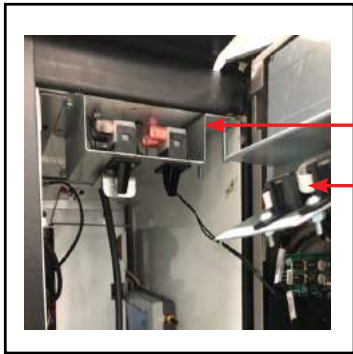

28

3

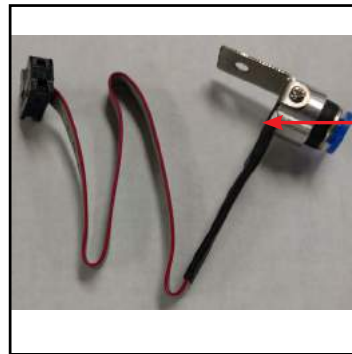

3

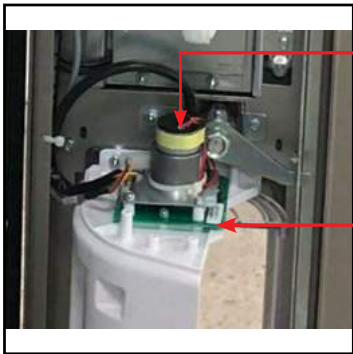

5

6

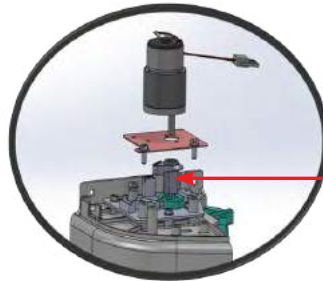

7

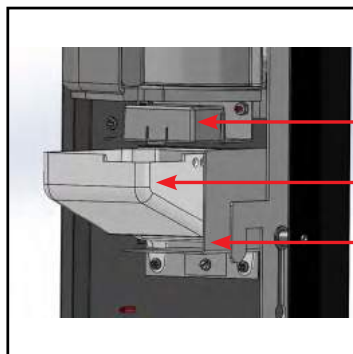
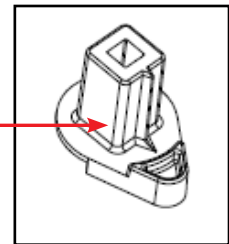

8

26

25

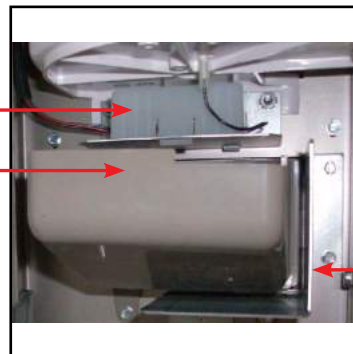

25

Service Door (A)

ITEM REF	PART DESCRIPTION	Wide 5800-6HC	Narrow 3800-6HC
1	LED Board Cover	400718	
2	Assy, Cover LED Board and Light Engine Bracket Affective	400829	
3	Light Engine	400963	
4	Assembly Port	110680	
5	Port Motor, Short (Brushed)	101096	
6	Port Circuit Board (top of port assy)	100627	
7	Port Cam	101714	
8	Assy, Port Sensor FR4	105641	
9	Service Door Assembly, 9 Inch Touch, Platinum	Provide Machine Serial Number	
10	Port Motor Cover	100685	
11	Sign (Pill), Blue 9" Touch Integrated Coin, Bill, Credit Card (shown) Contact Crane Merchandising Systems Parts Order Entry when ordering Sign (Pill) replacements. See page 19 for available layouts.	Contact Parts Order Entry	
12	Weld Assembly Service Door, 9 Inch Touch, Platinum	106093	
	Weld Assembly Service Door, 9 Inch Touch, Black	104754	
13	9 Inch Touch Screen Display	110706	
14	Bezel Center, Upper (Champagne)	112907	
	Bezel Center, Upper (Black)	112894	
15	Bezel Center, Lower (Champagne)	101355	
	Bezel Center, Lower (Black)	101339	
16	Top Door Hinge Assy., Service Door – shown on Machine Front View	104555	
17	Card Reader & Mag Head Assy. (clear swipe part) – Domestic Only	101357	

Parts not shown/ Cannot be seen.

Part numbers and descriptions subject to change without notice.

NA = Not applicable TBD = To be determined RB = Replaced by

Service Door (B)

ITEM REF	PART DESCRIPTION	Wide 5800-6HC	Narrow 3800-6HC
18	DEX Harness, 12" – shown on Harness view	101004	
19	PCB LED Assembly – shown on Electronics view	100638	
20	LED Driver Board Assy. – shown on Electronics view	102975	
21	Integrated Bill Payment Bracket Assy. (shown)	110714	
	Standard Payment Bracket (not shown)	106108	
22	T Handle Assembly Offset (L shape) Includes: T Handle Body Offset, T Handle Basket, T Handle Offset, T Handle Stop Washer, Internal Tooth Washer, Jam Nut, T Handle Spring, T Handle Pin.	102641	
23	Lock Bar	104773	
24	Latch Bar Pawl	102699	
25	Lower Vandal Bracket	104724	
26	Coin Return Cup, Champagne	101733	
	Coin Return Cup, Black	101734	
27	Coin Return Cup Flap, Champagne	102830	
	Coin Return Flap, Black	102831	
28	New Door Switch Bracket Assy – <i>applicable to venders serialized 111904030102 and higher</i>	400349	
29	E-Lock Media Bev 4 CCEP	400853	
	E-Lock Media Bev 4	NA	
	Cover E-lock	105436	

Parts not shown/ Cannot be seen.

Part numbers and descriptions subject to change without notice.

NA = Not applicable TBD = To be determined RB = Replaced by

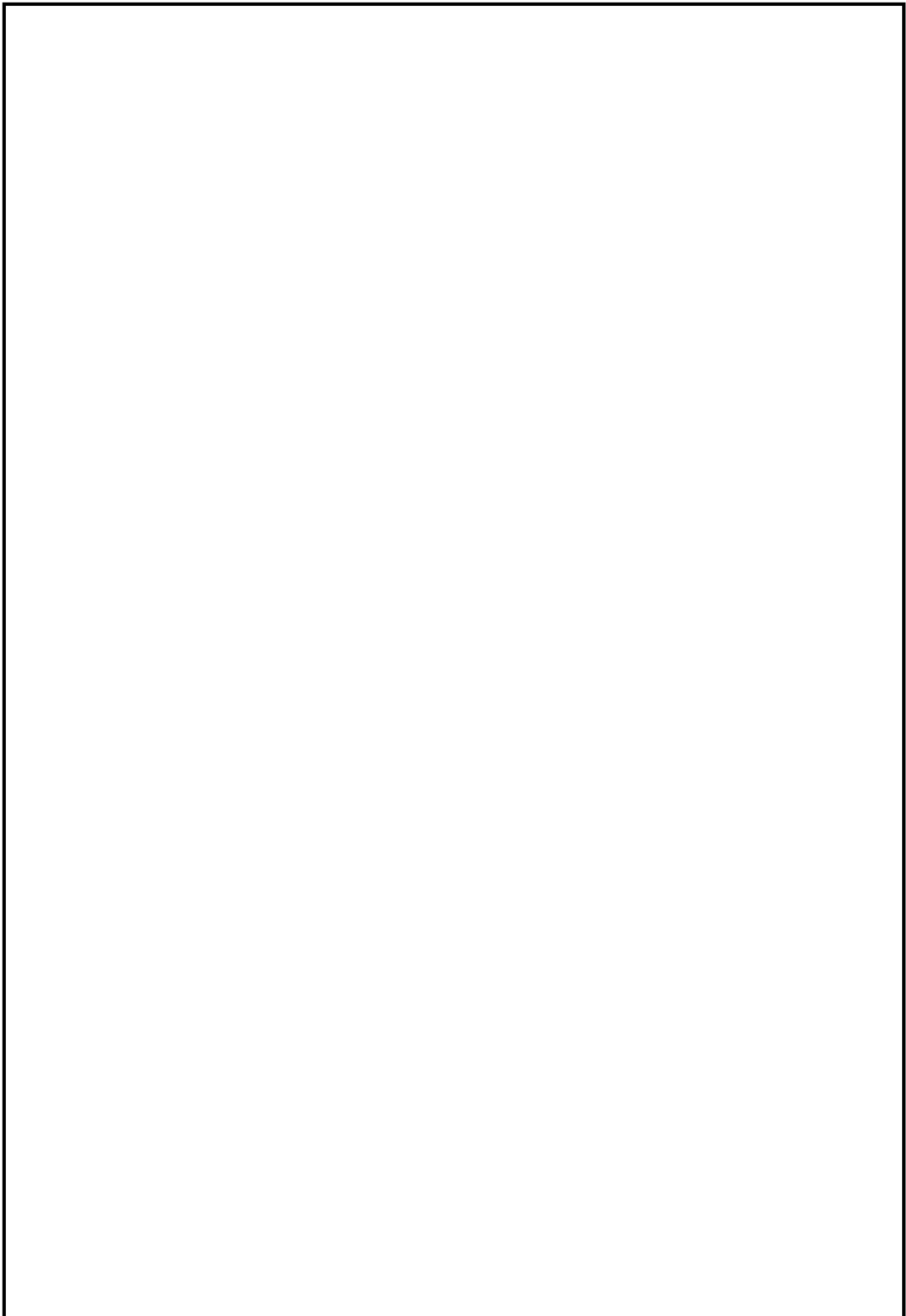

Service Door Pills

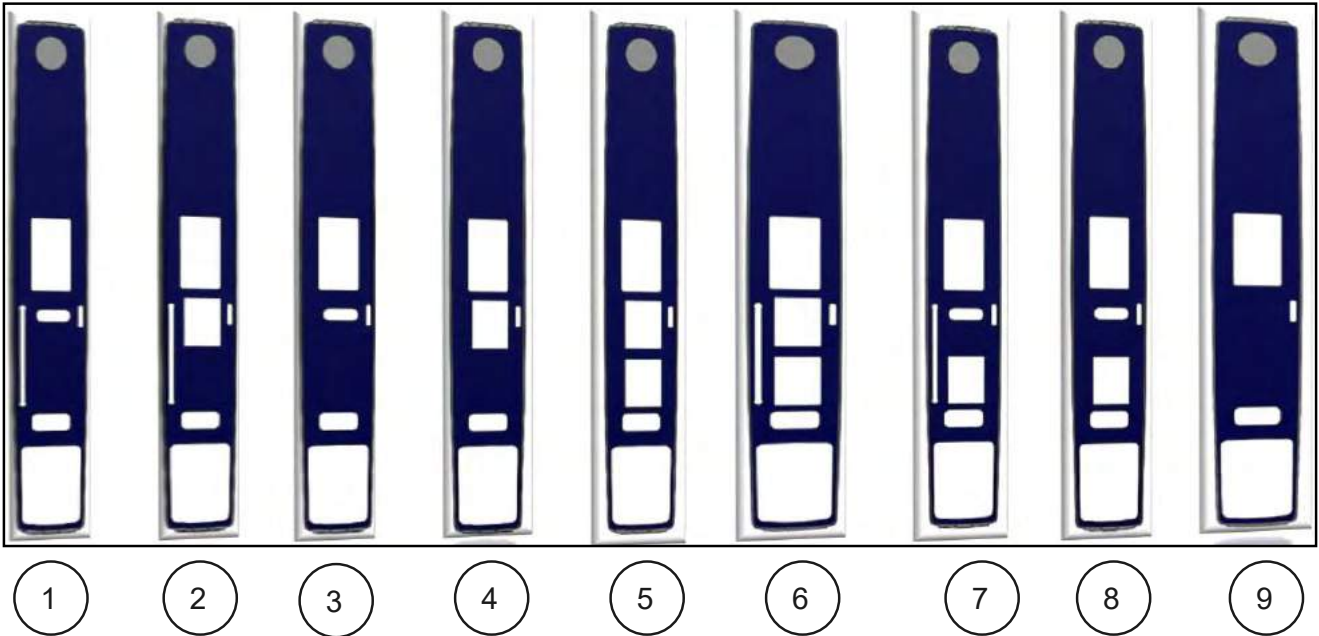

Item	Touch Screen Dim. (inch)	Available Integrated Payment Method			Knockout Type	Item Number	
		Coin	Bill	Credit Card		Blue	Black
1	9"	✓	✓	✓		401006	401146
2	9"	✓		✓	Upper	401007	401147
3	9"	✓	✓			401008	401148
4	9"	✓			Upper	401009	401149
5	9"	✓			Upper/Lower	401010	NA
6	9"	✓		✓	Upper/Lower	401011	NA
7	9"	✓	✓	✓	Lower	401012	NA
8	9"	✓	✓		Lower	401013	NA
9	9"					401014	NA

***Most Common Pill Configurations Shown. Additional Configurations Available, Please Call And Provide Machine Serial #.**

Part numbers and descriptions subject to change without notice.

NA = Not applicable TBD = To be determined RB = Replaced by

Gate Tray Detail

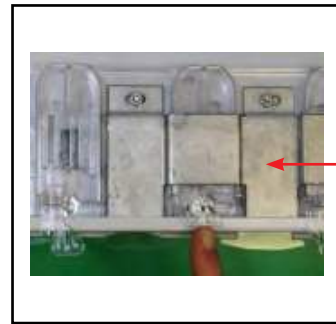
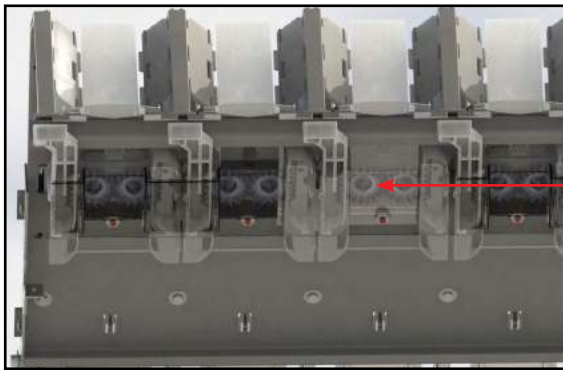
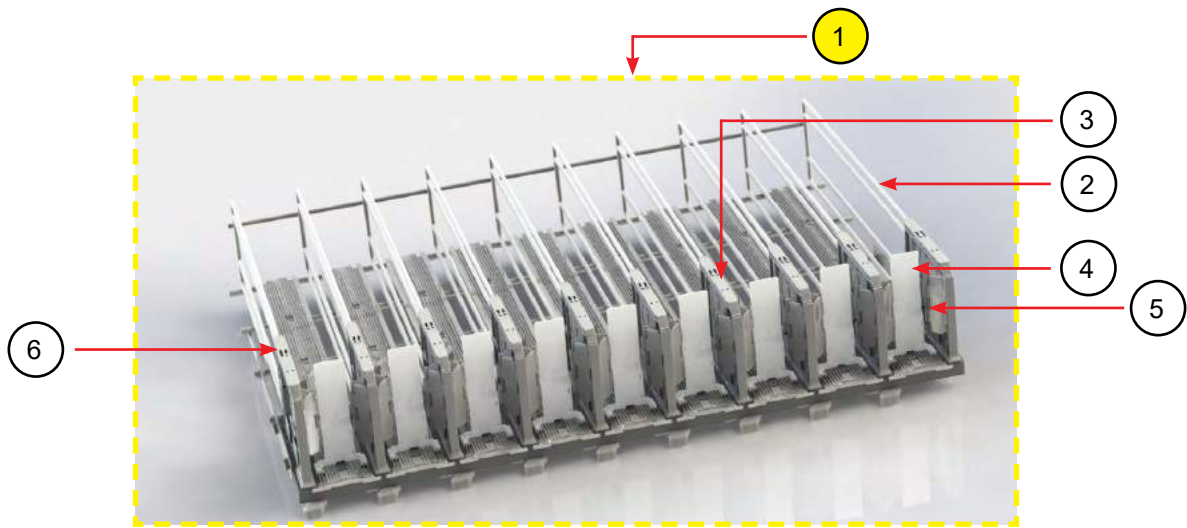

Square Gate
Standard in Domestic Equipment

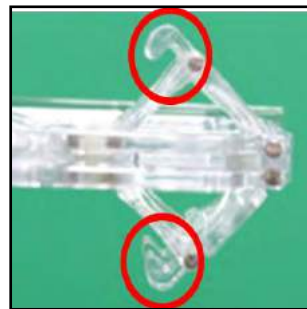

Standard Gate
Standard in Export Equipment

Gate Tray Detail

ITEM REF	PART DESCRIPTION	Wide 5800-6HC	Narrow 3800-6HC
1	Tray Assembly, 9 Column Original Gates	105565	NA
	Tray Assembly, 9 Column Square Gates	110682	NA
	Tray Assembly, 7 Column Original Gates	NA	104709
	Tray Assembly, 7 Column Square Gates	NA	111393
2	Tray Wire, Formed Domestic 9 Column (Wide)	101854	NA
	Tray Wire, Formed Domestic 7 Column (Narrow)	NA	101855
3	Double Original Gate Assembly Kit (gate & 2 screws)	111801	
	Double Square Gate Assembly (Kit NA)	101788	
4	Slide with Product Pusher Assembly	103047	
5	Double Original Gate Assembly Right Kit (gate & 2 screws)	111799	
	Double Square Gate Assembly Right (Kit NA)	101790	
6	Double Original Gate Assembly Left Kit (gate & 2 screws)	111800	
	Double Square Gate Assembly Left (Kit NA)	101789	
7	Gear Box Assembly, 3 column	102850	
	Gear Box Assembly, 2 column	NA	102851
8	Chassis Tray, Tall Gate	102808	NA
	Chassis Tray, Tall Gate – (part of 104709)	NA	102809
9	Gear Box Brace (used with Square Gate Assemblies only)	104830	

Parts not shown/ Cannot be seen.

Part numbers and descriptions subject to change without notice.

NA = Not applicable TBD = To be determined RB = Replaced by

AC Distribution Box

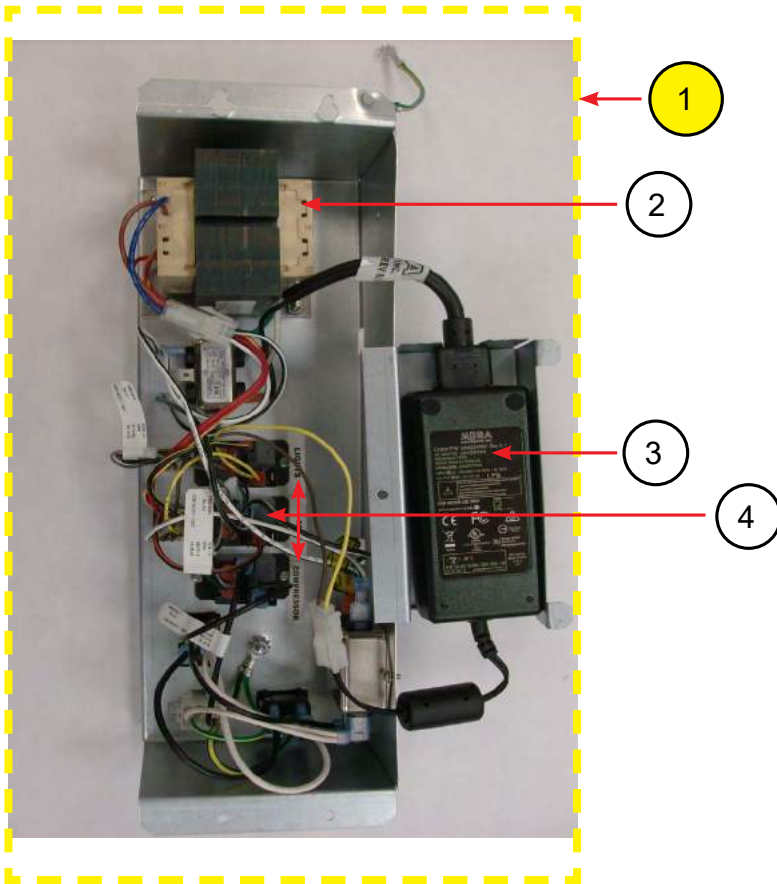

AC Distribution Box			
Item Ref	Description	Export	Domestic
1	Assembly AC Distribution Box, BevMax 6 – R290	114915	111286
2	TRANSFORMER	101238	101241
3	POWER SUPPLY 24VDC 72W	103071	
4	RELAY FAN COMP & LIGHT	101145	

Parts not shown/ Can not be seen

Part numbers and descriptions subject to change without notice.

NA = Not applicable TBD = To be determined RB = Replaced by

Lighting LED

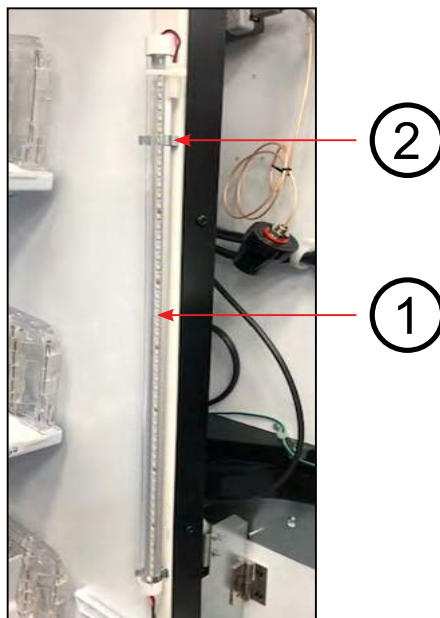
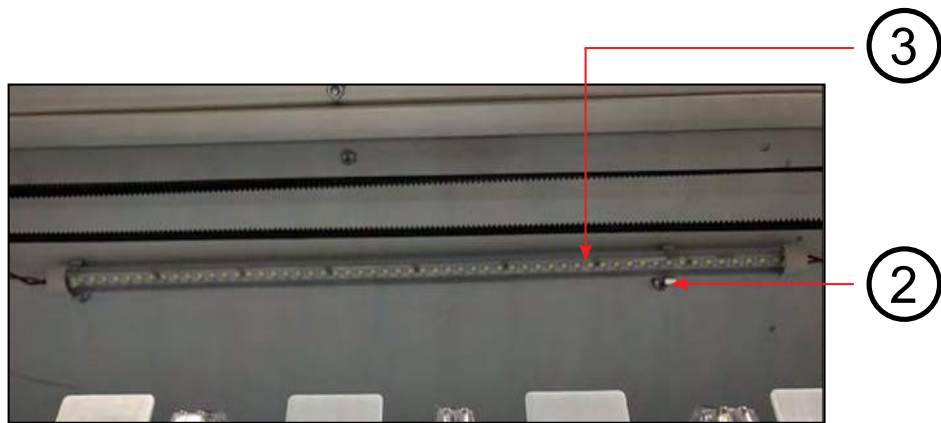

LED Lighting			
ITEM REF	PART DESCRIPTION	Wide 5800-6HC	Narrow 3800-6HC
1	Vertical (Side) Light Assy. (includes: 2 Lamps 500MM LED, 4 Clips, & 4 Screws) 20" length	108657	
2	LED Spring Clip	100069	
3	Horizontal (Top) Light Assy. (includes 1 Lamp 500MM LED, 2 Clips, & 2 Rivets) 20" length	105571	

Parts not shown/ Can not be seen

Part numbers and descriptions subject to change without notice.

NA = Not applicable TBD = To be determined RB = Replaced by

Refrigeration Unit

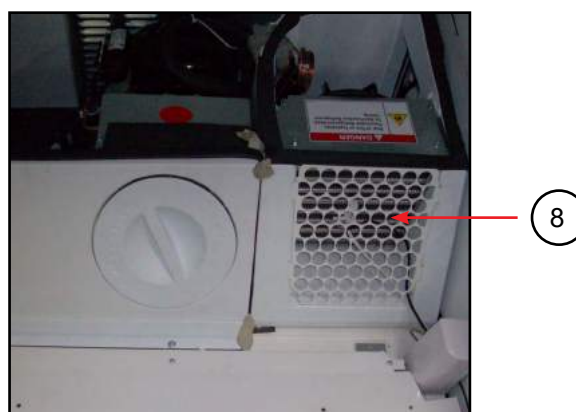
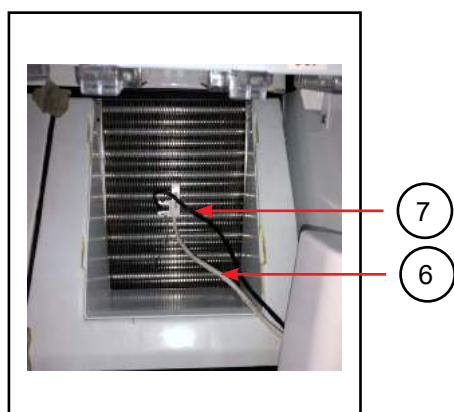
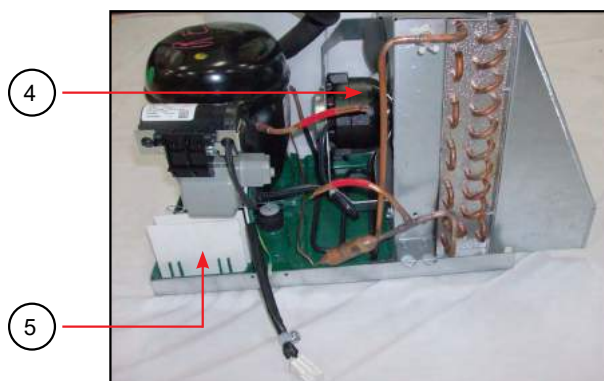
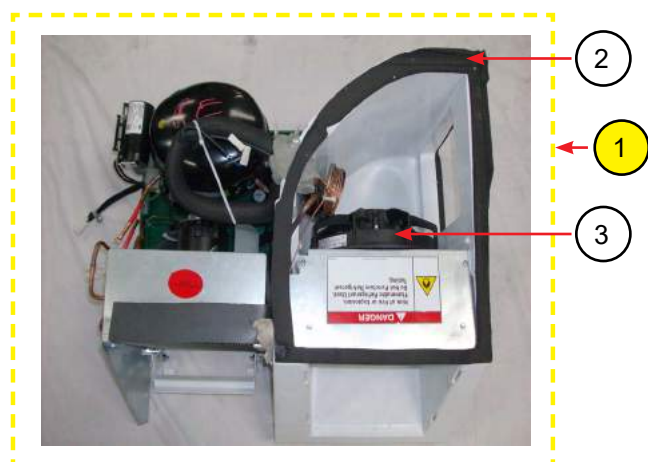

Refrigeration Unit			
ITEM	PART DESCRIPTION	Domestic	Export
1	Assy Refrigeration Unit	105579	400715
2	Gasket Assy	102757	
3	Fan Evaporator	110719	101628
4	Fan Condenser	104559	104583
5	Soaker	101658	
6	Encapsulated Temp Sensor	101160	
7	Defrost Control	115161	
8	Grill	102854	

**Part numbers and descriptions subject to change without notice.
 NA = Not applicable TBD = To be determined RB = Replaced by**

Electronics

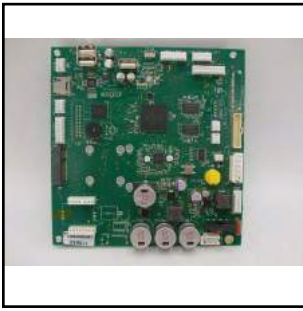

1



2



3



4



5

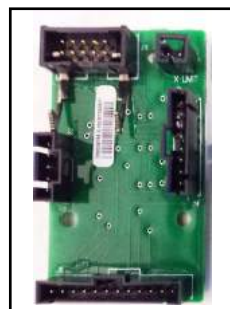

6



7



8

Electronics			
ITEM	PART DESCRIPTION	Domestic	Export
1	Media 2 R290 Atlas H Board	110640	
2	PCB LED Assy.	100638	
3	LED Driver Board Assy.	102975	
4	PCB Cold Drink I/O Board Assy.(Interface Board)	400195	
5	9 Inch Touch Screen Display	115524	
6	Y Motor Board, R290	100639	
7	XY Motor-R290 (also see XY Motor Picker Unit)	101102	
8	UIC 680 NFC Reader Electronic Board	400057	
9	Integrated NFC LED Retrofit Kit	106770	

Parts not shown/ Can not be seen

Part numbers and descriptions subject to change without notice.

NA = Not applicable TBD = To be determined RB = Replaced by

Harness



1



2



3



4



5



6



7



8



9



10



11



12



13



14



15



16



17



18



19



20

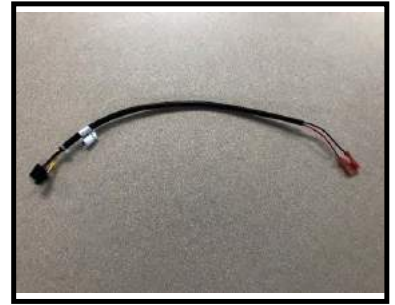

21



22











23





Harnesses							
ITEM	PART DESCRIPTION	From	Connector	TO	Connector	Wide 5800-6HC	Narrow 3800-6HC
1	Harness, Coin Return Motor	J7 I/O Board	3 Pin	Coin Return motor board	6 Pin	101006	
2	Harness, 9" Touch Media 2	J10 of Atlas Board	50 Pin	Touch screen back	40 pin	110697	
3	Harness, X Motor, 74" long	P15 IO Board	9 pin	X Motor	8 pin	100995	
4	Relays Extension Harness, 24" long	IO Board	10 pin flat black	AC Distribution Box	4 pin white	101017	
5	Harness, AC Distribution Interior Power, 28" long	P1 IO board;	3 Pin White;	AC Distribution Box; evaporator fan; Lamp Harness	9 Pin; 2 Pin white; 2 Pin	101012	
6	Harness, Evaporator, 80" long	AC Box Harness	2 pin white plug	evaporator fan harness	2 spade plugs	100975	
7	Harness, LED Media	J4 Atlas board	6 pin connector	J2 of LED Driver board	6 pin connector	101002	
8	Harness, Y Motor E Chain	J1 of Y board	10 pin Gray	delivery cup harness	10 pin Gray	101007	
9	Harness, Door Switch Media, 18" long	J7 Atlas board	2 pin white connector	Right Door Switch	Black Wire 2 Flags	400438	
10	Encapsulated Temp Sensor	J12 IO Board	6 pin white connector	Temp Sensor	Evaporator Coil	101160	
11	Harness, DEX Panel Mount 12" long	J16 Atlas board	4 pin flat white connector	DAX & light engine bracket	RS232 connector	101004	
12	Harness, X/Y E Chain R290, 60" & 53" long	P14 & P8 IO Board	12 & 5 pin	P6 Y Board	14 & 5 pin	105759	100811
13	Power Interrupt Sw. (Motor By Pass) 21" long	P3 I/O board	2 pin white connector	Left Power Interrupt Switch	grey wires – Common, Normally Open	100968	
14	Harness, Door Bundle R290	P2 & J1 I/O Board	12 & 8 pin	Port/MBD Atlas/MBD	7,4,6,4 pin	400684	
15	Harness, LED Badge	LED Driver Board	5 pin socket	PCB LED Assy. behind top of pill	4 pin socket	111795	
16	Harness, LED Bundle	J16 & J9 LED Driver Board	10 & 8 pin	LED Board	4,4,4,4 pin	101015	
17	Harness, LED Controller Power	J1 LED driver board	3 pin	Lights / AC Box	2 & 2 pin	100836	
18	Ground, Chassis 16AWG, 15"	AC Box	Ring Term	SVC Door	Ring Term	100725	
19	Harness LED Power	AC Box	2 pin	Lower Lamp	2 pin	400299	
20	HARNES, ELOCK,HICAP	E-Lock	12 pin		2,2 pin	400643	
22	NFC BADGE HARNESS MEDIA	J15 LED driver board	4 pin	LED Board	4 pin	101020	
23	USB CABLE HARNESS TO UIC	Atlas	USB	UIC	7 pin	100841	





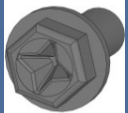

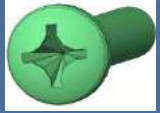





**Part numbers and descriptions subject to change without notice.
NA = Not applicable TBD = To be determined RB = Replaced by**







Screws			
Item	Part Number	Part Name & Discription	Picture
1	100262	Screw, Phil Pan Sem 10 – 32 x ½”	
2	100266	Screw, Phil Pan #8 - 32 x 3/8”	
3	100265	Screw, Phil Pan w/out washer self drilling, #8 - 18 x 1/2”	
4	100318	Screw, Phil Pan Swage Form #8 - 32 x 1/4”	
5	100327	Screw, Phil Pan #2-32 x 3/8”	
6	100280	Screw, Phil Pan, #2-32 x 1/2”	
7	100304	Screw, Hex Washer Head #6 – 19 x .5”	
8	100259	Screw, Hex Head ¼-28 X .5	
9	100325	Screw, Phil Pan #8 - 32 x 5/8”	
10	100267	Screw, Phil Pan Sems with washer, #8 - 18 x 1/2”	

Screws			
Item	Part Number	Part Name & Discription	Picture
11	100319	Screw, Self Tapping, 1/4 - 20 x 5/8”	
12	100277	Screw, Hex Washer 8x5/8”	
13	100328	Screw, Phil Pan with lock washer #4 - 40 x 3/8”	
14	100316	Screw, Phil Pan #8-18x1/2”	
15	100276	Screw, Hex Head 10-16x .50	
16	100326	Screw, Phil Pan #8-18x.375”	
17	100281	Screw, Phil Pan #8-18x5/8”	
18	100311	Screw, Phil Pan Swage Form #8-32x1/2”	
19	100275	Screw, Hex Washer Head #8-18x1/2”	
<p>Part numbers and descriptions subject to change without notice. NA = Not applicable TBD = To be determined RB = Replaced by</p>			







Screws			
Item	Part Number	Part Name & Discription	Picture
20	100255	Screw, Pan Head #6-32 X ¼	
21	100332	Screw, Wing ¼ - 20 x 1 ¼ molded nylon (for shipping bracket)	
22	100341	Screw, Nylon (Circuit Board Support – Display)	
23	100287	Screw, TEK Zinc #20 X .750	
24	100298	Screw, Fl. Torx Tap ¼-20 X ½	
25	100289	Screw, Shoulder ¼-20 X .35	
26	100241	Screw, Hex w/ Head, Hi-Lo #6 X ½	
27	100256	Screw, Hex Button Head 10-32 X 5/8	
28	100260	Screw, 10-32 X 1.375	





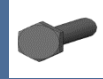

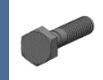
Screws			
Item	Part Number	Part Name & Discription	Picture
29	100239	Screw, Hex Head 8-32 X .81	
30	100321	Screw, Hex w/ Washer 8-32 X 3/8	
31	100243	Screw, TIF PHS 8-10 X .5	
32	100242	Screw, Hex w/ Head #8-32 X .31	
33	100238	Screw, Phil Pan Zinc 8-32 X 1	
34	100240	Screw, Hex w/ Washer #8-18 X .62	
35	100286	Screw, Mounting Condenser Motor	Included with Fan assembly 101633
36	102887	Knob, Thumb Screw Round	
Part numbers and descriptions subject to change without notice. NA = Not applicable TBD = To be determined RB = Replaced by			

Nuts			
Item	Part Number	Part Name & Description	Picture
B1	100155	Hex Nut, #10 - 32	
B2	100156	Hex Nut, 1/4 - 20	
B3	100153	Hex Nut, #8 - 32	
B4	100182	Nut, Serrated Flange 3/8 - 16	
B7	100154	Elastic Stop Nut, #8 - 32	
B10	100173	Push Nut ID .250	
B11	100150	Push Nut Washer Cap Type	
B12	100148	Nylon Insert Lock Nut 1/4 - 20	
B13	100170	Nut, 10-32 Nylock	
B14	100164	Nut, 1/4-20 Pem-nut C420-1	
B15	100171	Nut, Speed Cond. Motor	
B16	100178	Nut, Machine Hex 1/4 - 28	
B17	100146	Nut, Hex Zinc #8 - 32	







Washers			
Item	Part Number	Part Name & Description	Picture
C1	100506	Washer, EPDM 1-1/16 OD, 1/2 ID	
C2	100507	Washer, Flat 1/2 ID, 1.25 OD	
C3	100503	Washer, .260 ID x .687 OD Flat	
C5	100509	Washer, .191 ID x .5 OD x .054T Flat	
C6	100487	Washer, SS Flat #10	
C7	100488	Washer, Flat 18 Gauge 17/64ID x 5/8OD	
C10	100501	Washer, Nylon .375	







**Part numbers and descriptions subject to change without notice.
 NA = Not applicable TBD = To be determined RB = Replaced by**

Bolts			
Item	Part Number	Part Name & Description	Picture
D1	100009	Bolt, Carriage ¼ - 20 x 2.5	
D2	100016	Bolt, Carriage 3/8 - 16 X 1 3/4"	
D3	100012	Bolt, ¼-20 X 1.75	
D4	100010	Bolt, Carriage ¼-20 X 2	
D5	100011	Bolt, Hex ¼-20 X 1.25	
D7	100014	Bolt, Flange ¼ - 20	
D8	100013	Bolt, Carriage #10 - 24 X 1¼	
	105634	Threadlocker	No Image

Rivets			
Item	Part Number	Part Name & Description	Picture
E1	100223	Pop Rivet, Stainless Steel .125 Dia X .265	
E2	100229	Pop Rivet, Steel (Zinc Plated) 1/8"	
E3	100228	Pop Rivet, Steel (Zinc Plated) 3/16"	
E4	100226	Pop Rivet, Aluminum 1/8" White	
E5	100231	Rivet, 3/16 Countersink	
E6	100224	Rivet, Bulbex 3/16 Black	
E7	100227	Pop Rivet, Steel 3/16 Black	



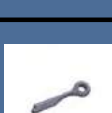



Part numbers and descriptions subject to change without notice.
 NA = Not applicable TBD = To be determined RB = Replaced by

Clips and Pins			
Item	Part Number	Part Name & Description	Picture
F2	100221	Retaining Ring	
F4	100199	Pin Self Clinching .250 x 3/4	
F5	100047	Bushing, .5 X .691 X .187	
F6	100196	Pin Belt Tensioner Idler Pivot	
F7	100106	E Ring Ext 1/4 #E-25	
F8	101171	Standoff Richo RLCBSR401SR	
F9	100200	Pin Self Clinch .250 x 1	

Clips and Pins			
Item	Part Number	Part Name & Description	Picture
F14	100410	Belt Tensioner Spring	
F17	100088	Clip, Retainer Compressor	
F18	100384	Spacer, 1/4ID X .275	
F19	100388	Spacer .312 OD X .171 ID X .250	
F20	100210	Cotter Pin .076 X .500	
F21	100069	Steel Spring Clip LED	
F22	101167	Standoff Flush Head #6 - 32 X 3/8	

Miscellaneous	
Part Number	Part Name & Description
101814	Pulley Roller (4 per carriage)
103020	Double Roller Catch (Dart & Latch)
102922	Flat Mount Cable with adhesive
104864	Cord Cover
100086	Flat Wire Clip
Part of Slide with Product Pusher Assy	Product Pusher Spring

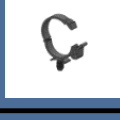
**Part numbers and descriptions subject to change without notice.
 NA = Not applicable TBD = To be determined RB = Replaced by**

Wire Clamp			
Item	Part Number	Part Name & Description	Picture
H1	100218	Plug, Dome Black .50	
H2	100514	Wire Tie, 7 1/2"	
H3	100513	Wire Tie, 4"	
H4	100516	Wire Tie, Twist	
H5	100056	Clamp, Nylon 5/16" White	
H7	100068	Clamp, .250 Push Fin Base	
	105476	Shipping Bracket	
	100332	Screw, Wing 1/4 - 20 X 1 molded nylon (Shipping)	

**Part numbers and descriptions subject to change without notice.
 NA = Not applicable TBD = To be determined RB = Replaced by**

Notes

