

BevMax MEDIA

Parts Manual



CRANE

3330 Dixie Narco Blvd • Williston SC 29853

www.cranems.com

English #####

PARTS LIST

PARTS LIST AND DIAGRAMS	3 – 37
Machine Front View	4 – 5
Cabinet Detail Product Area	6 – 7
Cabinet Detail Service Door Area	8 - 9
XY Motor Picker Unit.....	10 – 11
Delivery (Picker) Cup Assembly	12 – 13
Service Door (A).....	14 – 15
Service Door Sign (Pill) Layouts	16 – 17
Service Door (B).....	18 – 19
Gate Tray Detail	20 – 21
AC Distribution Box.....	22 - 23
Lighting - LED	24 - 25
Refrigeration Unit Fin & Tube Condenser w/ Plastic Evap. Box.....	26 – 27
Electronics.....	28 - 29
Harnesses	30 – 32
Labels / Decals / Misc.	33
Screws & Nuts.....	35 – 35
Washers, Bolts, & Misc. Hardware	36 – 37

Special Note: Crane Merchandising Systems Dixie-Narco part numbering has changed. Many of the 11 digit numbers are now 8 digit numbers. The last 3 digits were dropped in the new numbering system. An example of this is 800,102,970.01 is now 80010297.

MACHINE FRONT VIEW

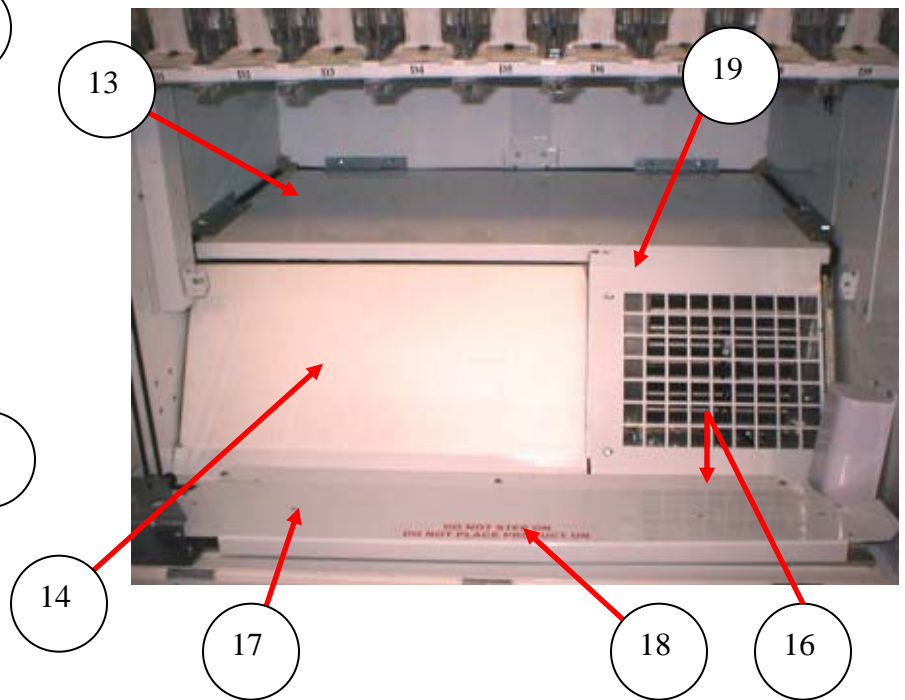
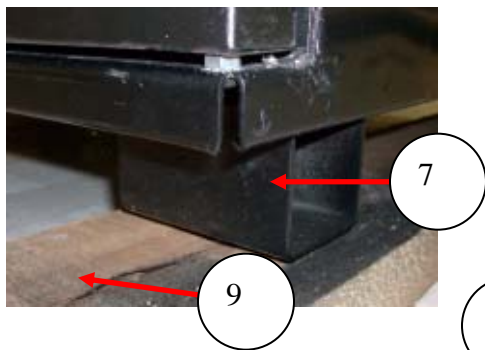
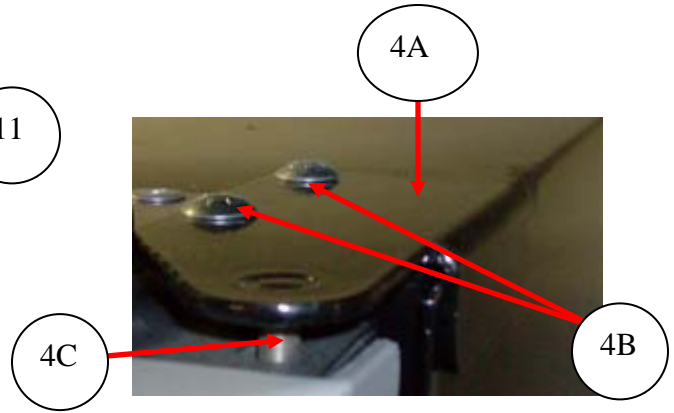
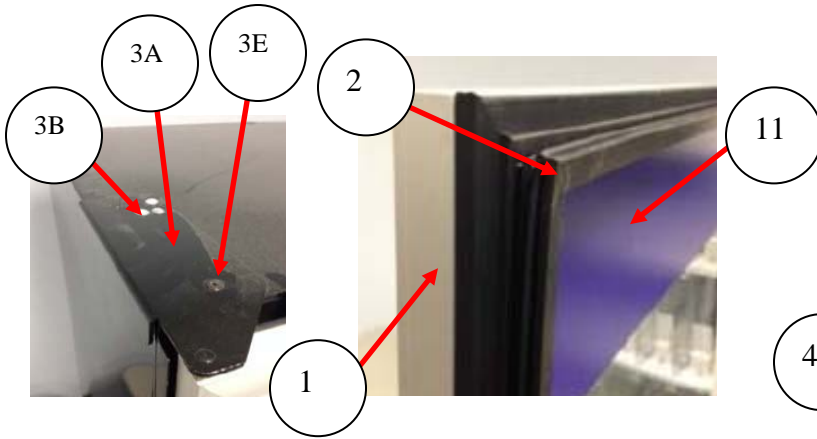
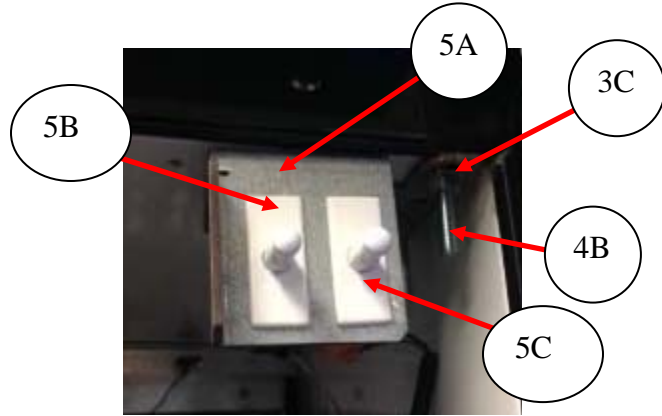
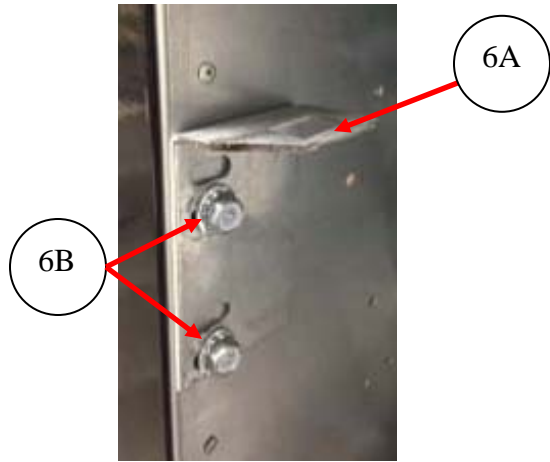

MACHINE FRONT VIEW

ITEM	PART DESCRIPTION	DN5800-6 DN5800-E6	DN3800-6 DN3800-E6
1	Door Assembly, Glass - Silver (does not include decals)	80010299	80010301
2	Gasket, Glass Door	80010297	80010298
3A	Top Hinge Glass Door (was 65700036)	*CR0014018	Same
3B	Carriage Bolt – ¼ - 20 x 2	80030542	Same
3C	Hex Nut – ¼ - 20	*80080157	Same
3D	Washer, Flat	*80070144	Same
3E	Screw, Fl. Torx Tap ¼-20 X ½	*AP13100035	Same
4A	Top Hinge Service Door	*CR0002256	Same
4B	Carriage Bolt, 1/4 –20 X 2.5" (also service door bottom hinge pin)	*80020249	Same
4C	Top Hinge Pin, Service Door	*CR0002219	Same
4D	Lock Nut, Service Door Hinge Pin Bolt ¼ - 20	*80030478	Same
4E	Washer, Service Door Hinge Pin	900,701,19x.x1	Same
5A	Door Switch Bracket – Double Switch	CR0021258	Same
5B	Power Interrupt Switch	*80410059	Same
5C	Lock Switch	*80410059	Same
6A	Door Latch High Security, 2 Point Lock	*CR0010839	Same
6B	Screw, Hex ¼ - 20 x 5/8	*80030436	Same
7	Leg Assembly, welded in place	*65700060	Same
8	Leg Leveler, 5/8 – 11 x 2 1/16 (not shown)	*80050379	Same
9	Shipping Boards, Domestic	*CR0000969	Same
	Shipping Boards, Export	*CR0004959	Same
10	Thermometer (not shown – Service Part only)	*80140155	Same
11	Wear Strip Door Decal	*80387837	Same
12	Glass Door Bottom Hinge Pin Hole	NA	NA
13	Bottom Panel Assembly	*CR0004713	CR0004585
14	Assembly Panel Slanted, with plastic evap box Refrig unit	*CR0007060	CR0007064
15	Door Stop	*64700045	Same
16	Wire Chase Assembly	*CR0004882	CR0004884
17	Ramp	*CR0002585	65707007
18	Warning Label, Ramp	*80388543	Same
19	Evaporator Inlet Grill, Plastic	*CR0007259	Same
20			
Part numbers & descriptions are subject to change without notice. NA = Not Applicable TBD = To Be Determined RB = Replaced By *Part used in BevMax 6 and BevMax 4 Venders.			

CABINET DETAIL PRODUCT AREA

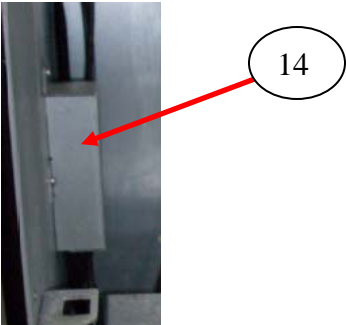
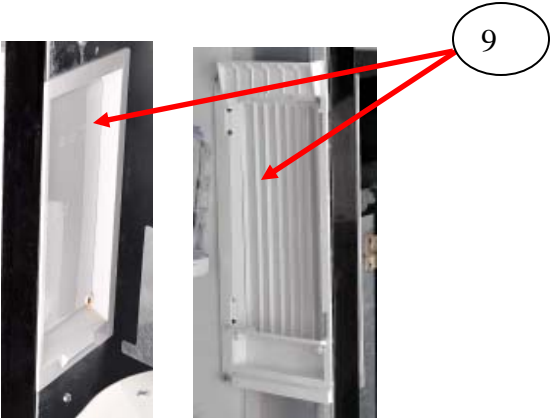
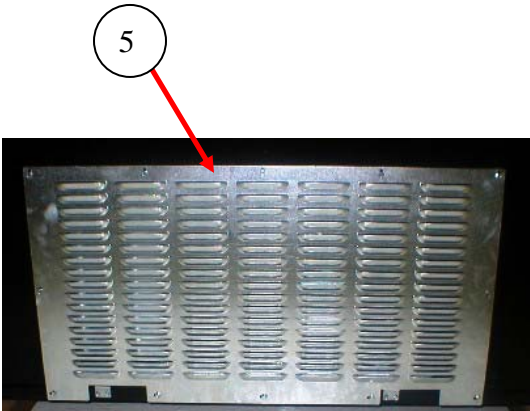
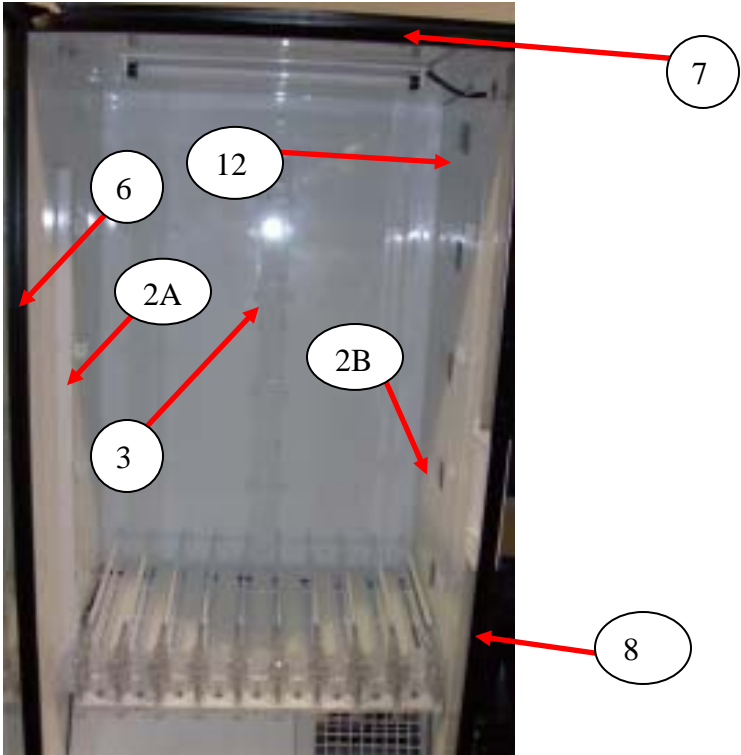

CABINET DETAIL PRODUCT AREA

ITEM	PART DESCRIPTION	DN5800-4 DN5800-E4	DN3800-4 DN3800-E4
1	Cabinet Assembly, Generic	*65706020	CR0002684
2A	Left Tray Support, 1 piece (5 shelf) - E3	*CR0006968	Same
	Left Tray Support, 1 piece (5 shelf) - E4	*CR0006970	Same
	Left Tray Support, 1 piece (5 shelf) - E5	*CR0007230	Same
	Left Tray Support, 1 piece (5 shelf) - E6	*CR0008225	Same
	Left Tray Support, 1 piece (5 shelf) - D2	*CR0005592	Same
2B	Right Tray Support, 1 piece (5 shelf) - E3	*CR0006967	Same
	Right Tray Support, 1 piece (5 shelf) - E4	*CR0006971	Same
	Right Tray Support, 1 piece (5 shelf) - E5	*CR0007231	Same
	Right Tray Support, 1 piece (5 shelf) - E6	*CR0008224	Same
	Right Tray Support, 1 piece (5 shelf) - D2	*CR0005593	Same
3	Rear Tray Support, 1 piece (5 shelf) - E3	*CR0006969	Same
	Rear Tray Support, 1 piece (5 shelf) - E4	*CR0006972	Same
	Rear Tray Support, 1 piece (5 shelf) - E5	*CR0007232	Same
	Rear Tray Support, 1 piece (5 shelf) - E6	*CR0008226	Same
	Rear Tray Support, 1 piece (5 shelf) - D2	*CR0005594	Same
4a	Tray Support Screw #8-18x1/2 Phil Pan (Self drilling, 9 per rail)	*80030418	Same
4b	Hex Washer Screw (2 per shelf)	*80030468	Same
5	Ingress Guard	*CR0007657	Same
	Ingress Guard with Screen Export	*CR0005110	Same
	Modified Rodent Guard Assy (use with CR0005110)	*CR0005102	Same
6a	Security Angle, Left was 64706007	*CR0000953	Same
6b	Security Angle Right (not shown)	*CR000954	Same
7	Security Angle, Top	*65700026	CR0002770
8	Door Seal Strip	*65706031	Same
9	Assembly Discharge Frame	*80181994	Same
10	Discharge Door Magnet	*80410105	Same
11	Discharge Port Diverter	*CR0007420	Same
12	Louver Panel Assembly	*CR0004574	Same
13	Defrost Control Mounting Bracket	64704003	Same
14	Defrost Control Cover	*CR0004136	Same
15	Defrost Control Vinyl Tube	*80190275	Same
16	Mesh Inlet Screen Assembly (near unit handle) - Export	*CR0005112	Same
Part numbers & descriptions are subject to change without notice. NA = Not Applicable TBD = To Be Determined RB = Replaced By *Part used in BevMax 6 and BevMax 4 Venders.			

CABINET DETAIL SERVICE DOOR AREA



1A

2D

2

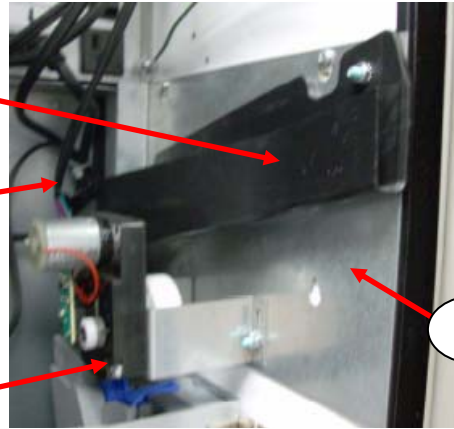

1B



11

2B

2C

2A

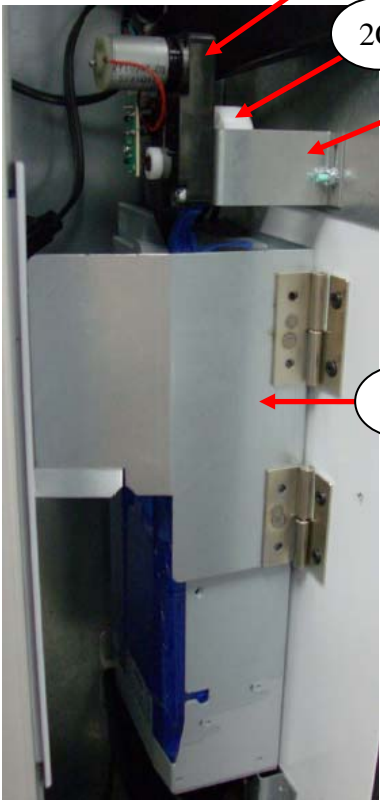

5

12A

12B

8

9

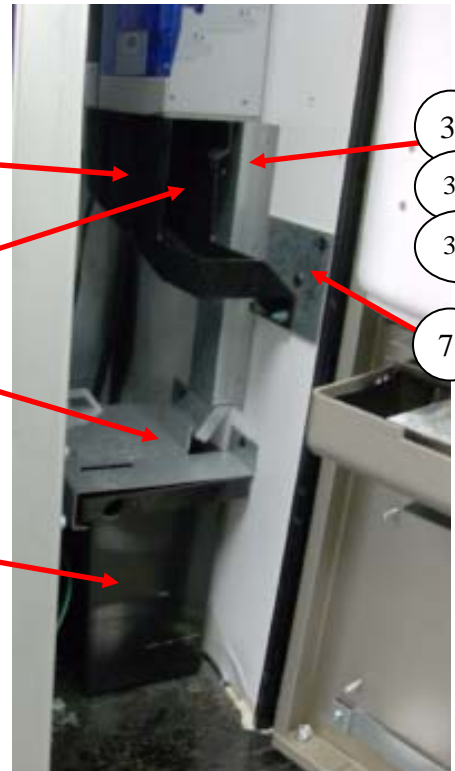

3

3A

3B

7

CABINET DETAIL SERVICE DOOR AREA

ITEM	PART DESCRIPTION	DN5800-6/3800-6 DN5800-E6/3800-E6	
1	Assy. Coin Return Bracket (1A+1B)	CR0013008	
1A	Upper Chute	CR0013005	
1B	Coin Bracket	CR0013007	
2	Coin Mech Electronic Return Assembly (2A+2B+2C)	CR0012862	
2A	Coin Return Motor Bracket	CR0012863	
2B	Motor & PC Board Assy	1577038	
2C	Coin Return Cam	1815028	
2D	Coin Return Motor Harness	CR0013440	
3	Assy. Modified Coin Box Chute (3A+3B)	CR0007266	
3A	Modified Coin Box Chute	CR0007262	
3B	Modified Coin Box Chute Back	CR0007261	
4	Cash Box Clip (not shown)	80181468	
5	Coin Mech Door Assembly	*CR0005660	
6	Flat Mount Cable with adhesive	*80480112	
7	Lower front Chute Mounting Plate Assy	CR0013133	
8	Cash Box Shelf (Cover)	CR0007000	
9	Cash Box, plastic	*4321228	
10	Locking Cash Box Kit	*432,011,50x.x4	
11	Coin Insert Ramp (on Service Door)	CR0012773	
12	Lower Coin Chute Assy. (12A+12B)	CR0022354	
12A	Lower Coin Chute	CR0013139	
12B	Coin Deflector	CR0013135	
13			
14			
15			
16			
Part numbers & descriptions are subject to change without notice. NA = Not Applicable TBD = To Be Determined RB = Replaced By *Part used in BevMax 6 and BevMax 4 Venders.			

XY MOTOR PICKER UNIT

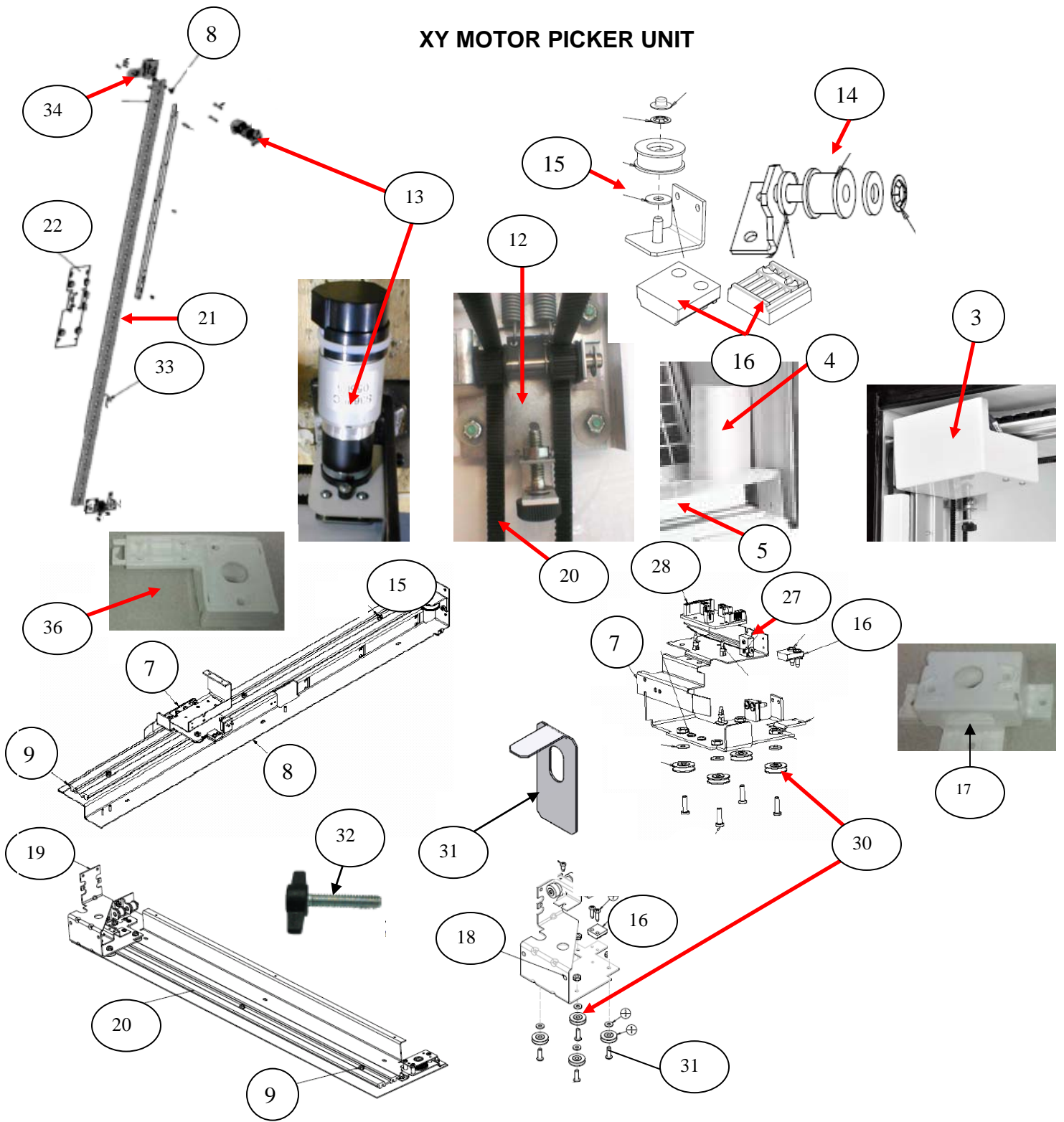

XY MOTOR PICKER UNIT

ITEM	PART DESCRIPTION	DN5800-6 DN5800-E6	DN3800-6 DN3800-E6
1	XY Delivery System	*CR0002183	*CR00027472
2	Assembly Cover Y Belt	*CR0001797	Same
3	Y Motor Cover Top	*80182329	Same
4	X Motor Cover Bottom	*80182328	Same
5	X Bottom Belt Cover (Ramp)	*CR0002585	*65707007
6	Harness, X Motor – bottom, not shown	*80492825	Same
7	X Top Carriage Assembly (top of XY)	*CR0002121	Same
8	X Axis Mounting Assembly Top	*CR0002133	*CR0002736
9	XY Extrusion (X track)	*80120188	*80120208
10	Harness, XY E Chain (Top horizontal) – not shown	*80492923	*80492894
11	Harness, Y E Chain (vertical) was 80492479	*CR0013743	Same
12	XY Belt Idler Tensioning Assembly (top left)	*64707970	Same
13	Motor XY System (Large D shaft)	*80450189	Same
	Motor XY System (Short)	CR0012833	Same
14	Idler Pulley and Bracket Assembly	*64708160	Same
15	X Top Idler Pulley Assembly	*64708110	Same
16	Belt Clamp	*80510003	Same
17	X Drive Pulley Assembly	*CR0006104	Same
18	X Axis Belt (22') (was 64707530)	*80510008	Same
19	X Bottom Carriage Assembly (bottom of XY)	*64708240	Same
20	Assembly X Axis Drive, Bottom	*64707930	*CR0002741
21	Assembly Y Axis	*CR0002127	Same
22	Y Carriage Assembly	*64708220	Same
23	Y Axis Belt (11.25') (not shown)	*80510007	Same
24	Screw Hex ¼ - 28 x .5	*80020284	Same
25	Spacer, ¼ ID X .257"	*80530071	Same
26	Hex Nut, ¼ - 28	*CR0004998	Same
27	Micro Switch with Straight Arm (X Home)	*80410131	Same
28	Y Motor Board	*80492532	Same
29	Y Extrusion	*80120207	Same
30	Pulley Roller	*80530054	Same
31	XY Shipping Bracket	*64707109	Same
32	Screw, Wing ¼ - 20 x 1 ¼ molded nylon (for shipping bracket)	*80030529	Same
33	Belt Tensioner Spring (Y Belt only)	*80140197	Same
34	Y Pulley Drive Assy.	*CR0005937	Same
35			
36			
Part numbers & descriptions are subject to change without notice. NA = Not Applicable TBD = To Be Determined RB = Replaced By *Part used in BevMax 6 and BevMax 4 Venders.			

DELIVERY (PICKER) CUP ASSEMBLY

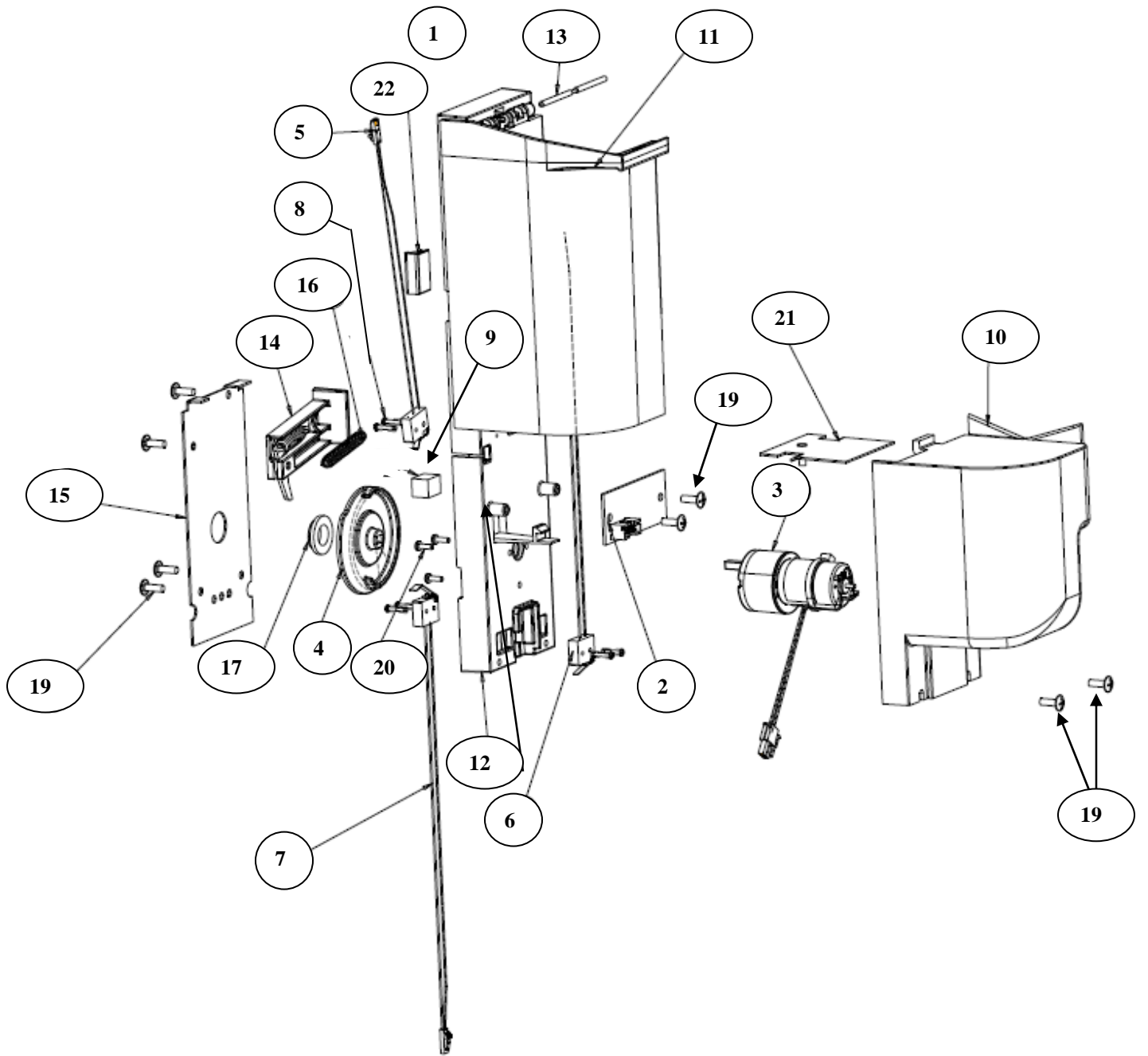

SERVICE DOOR (A)

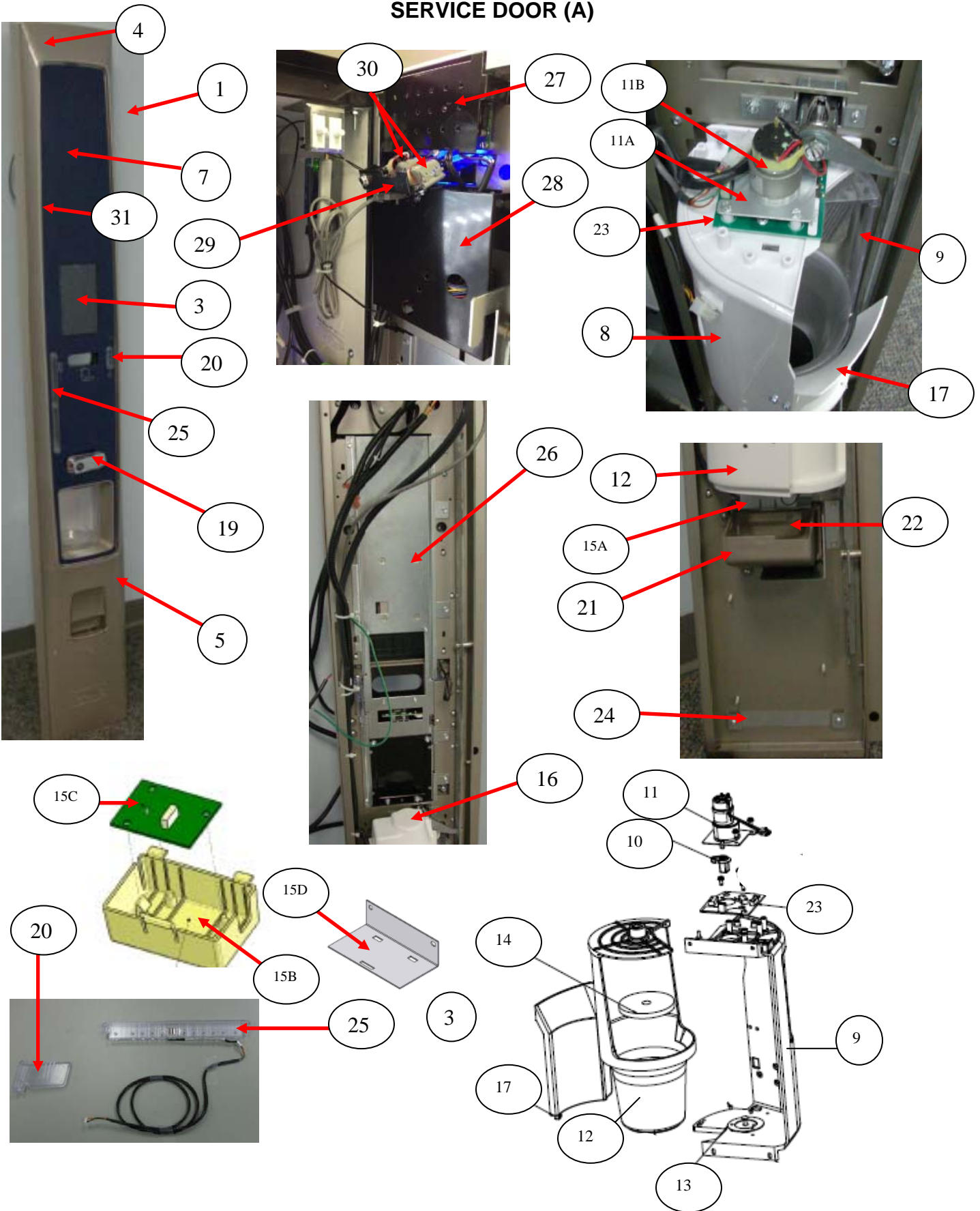

SERVICE DOOR (A)

ITEM	PART DESCRIPTION	DN5800-6 DN5800-E6	DN3800-6 DN3800-E6
1	Service Door Assembly, 7 Inch Touch, Platinum	CR0015437	Same
2	Weld Assembly Service Door, 7 Inch Touch, Platinum	CR0009370	Same
3	7 Inch Touch Screen Display	CR0021510	Same
4	Bezel Center, Upper	CR0012145	Same
5	Bezel Center, Lower	CR0012143	Same
6	Top Door Hinge Assy., Service Door	CR0002256	Same
7	Sign, Blue 7" Integrated Coin, Bill, Credit Card (Pill) (shown)	80504761	Same
	Sign, Black 7" Integrated Coin, Bill, Credit Card (Pill) (not shown)	80504762	Same
	Contact Crane Merchandising Systems Parts Order Entry when ordering Sign (Pill) replacements. See next page for layouts.	NA	NA
8	Assembly Port	*CR0015405	Same
9	Port Enclosure	*80182400	Same
10	Port Cam	*80182409	Same
11A	Bracket Motor Mount	64705045	Same
11B	Port Motor, Short	CR0012833	Same
12	Assembly Inner Cup Port	*80182097	Same
13	Vend Sensor Plate	*64705360	Same
14	Port Discharge Pad	*80360122	Same
15A	Vend Sensor Board Assembly, Port (15B+15C+15D)	*CR0003022	Same
15B	Port Sensor Cover/Housing	*CR0002214	Same
15C	Vend Sensor with Harness	*80492958	Same
15D	Vend Sensor Bracket	CR0007830	Same
16	Motor Port Cover	CR0012857	Same
17	Port Handoff Slide	*80182103	Same
18	Screw, Hex Button Head 10 - 32 x5/8 (secures bezels to panel)	80020250	Same
19	Assembly T Handle, Offset (L shape)	CR1293487	Same
20	Coin Insert Ramp	CR0012773	Same
21	Coin Return Cup (also see Service Door Inside)	CR0013137	Same
22	Coin Return Cup Flap, Champagne (not shown)	CR0021032	Same
23	Port Circuit Board (top of port assy)	*80492511	Same
24	Lower Bezel Mounting Bracket	CR0013129	Same
25	Card Reader & Mag Head Assy.	CR0014768	Same
26	Integrated Bill Payment Bracket Assy.	CR0014639	Same
27	LED Board Cover	CR0013470	Same
28	Atlas Board Cover	CR0012802	Same
29	DAX and Light Engine Bracket	CR0013096	Same
30	Light Engine	CR0010922	Same
31	Guide Flex Light (around Pill)	CR0010350	Same
32	Hex Nut, #8 – 32 (used to secure pill to door frame)	80080154	Same
33			

Part numbers & descriptions are subject to change without notice.
 NA = Not Applicable TBD = To Be Determined RB = Replaced By
 *Part used in BevMax 6 and BevMax 4 Venders.

Service Door Sign (Pill) Layouts



A



B



C



D



E



F



G



H



I

A	Pill 7" Touch with Integrated Coin, Bill, Credit Card
B	Pill 7" Touch with Integrated Coin & Credit Card + Upper Knockout
C	Pill 7" Touch with Integrated Coin, Bill, & no Credit Card
D	Pill 7" Touch with Integrated Coin & Upper Knockout
E	Pill 7" Touch with Integrated Coin, Upper & Lower Knockouts
F	Pill 7" Touch with Integrated Coin & Credit Card + Upper & Lower Knockouts
G	Pill 7" Touch with Integrated Coin, Bill, Credit Card + Lower Knockout
H	Pill 7" Touch with Integrated Coin, Bill + Lower Knockout
I	Pill 7" Touch

SERVICE DOOR (B)

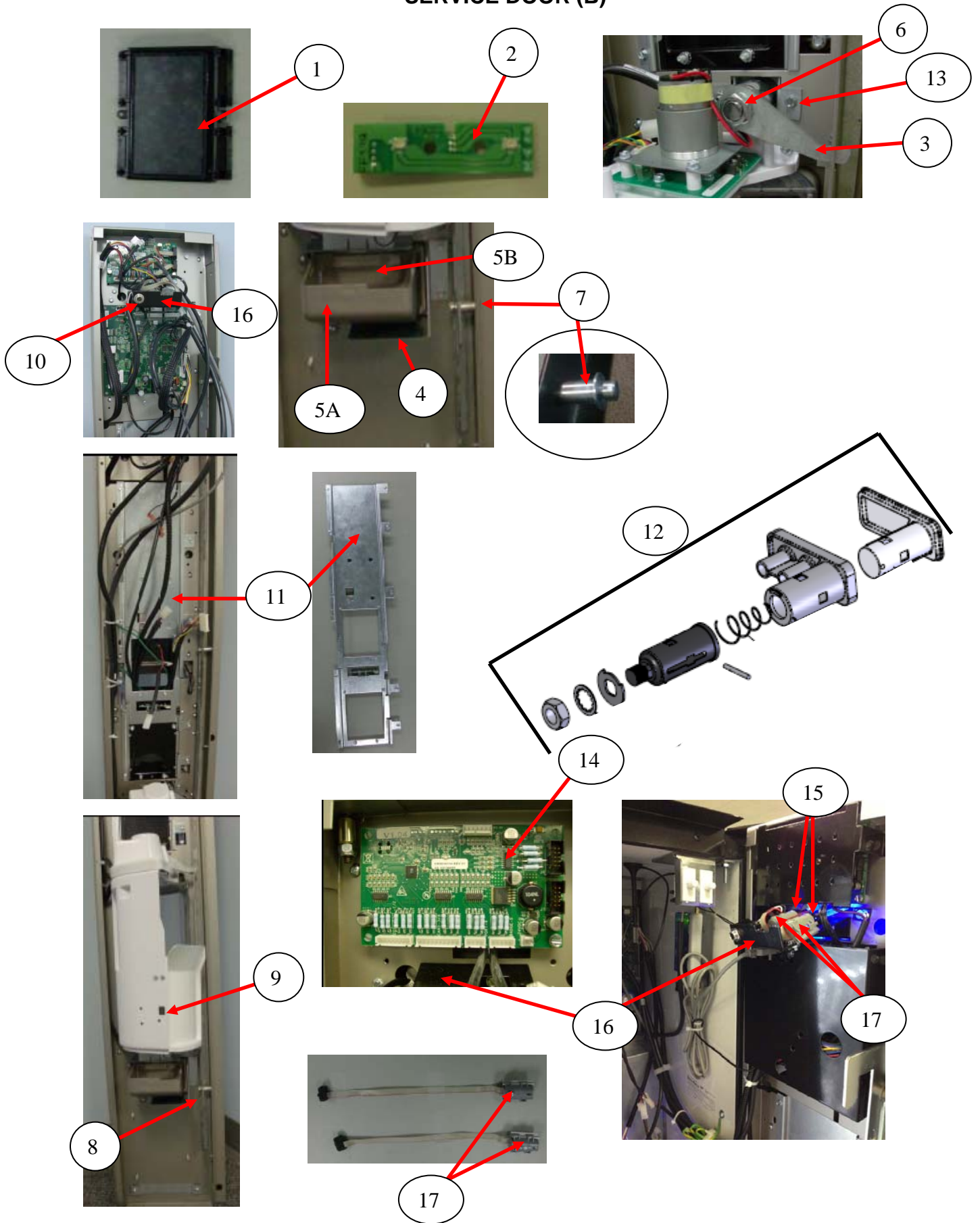

GATE TRAY DETAIL

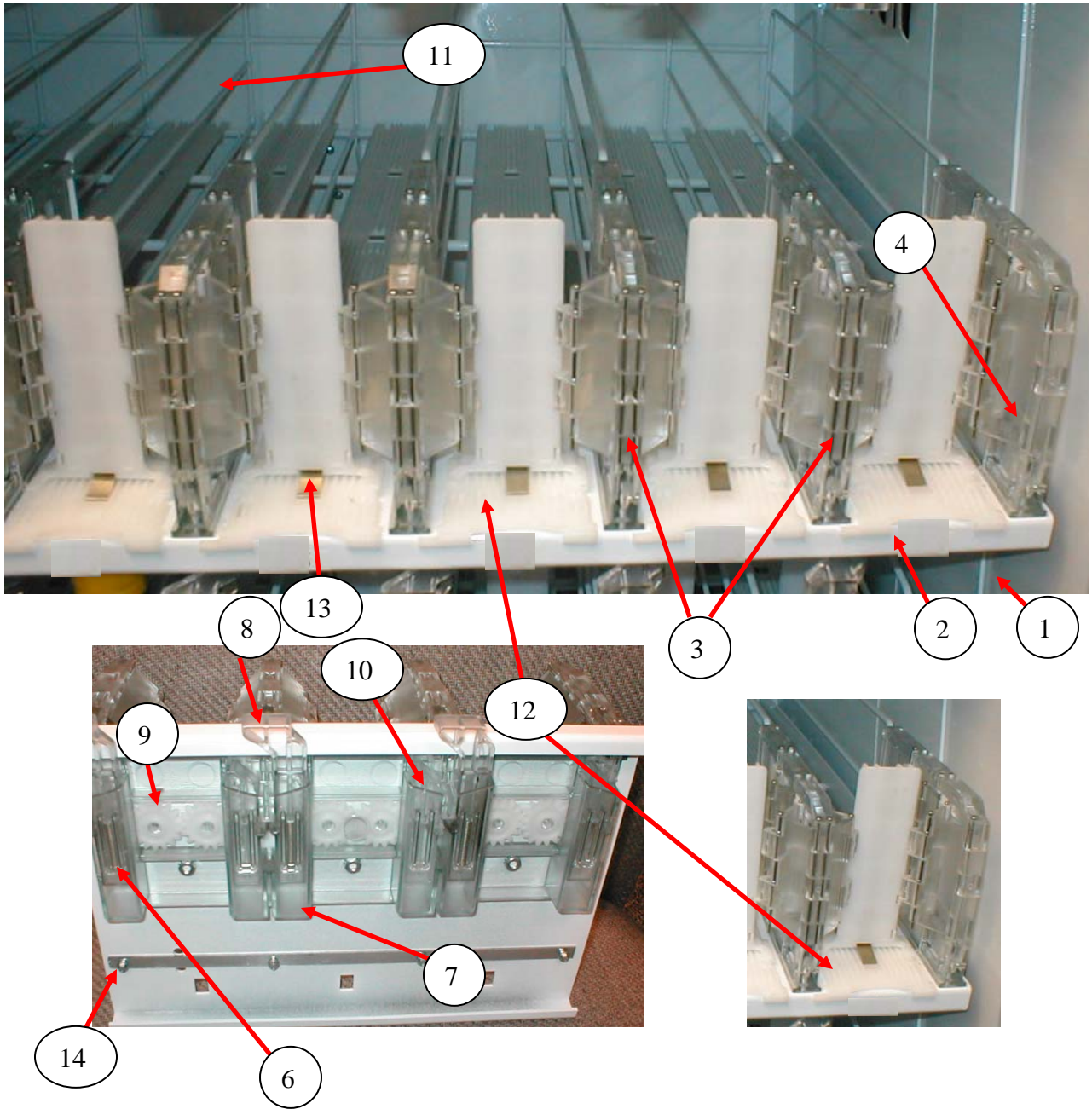

AC DISTRIBUTION BOX

Export AC Box

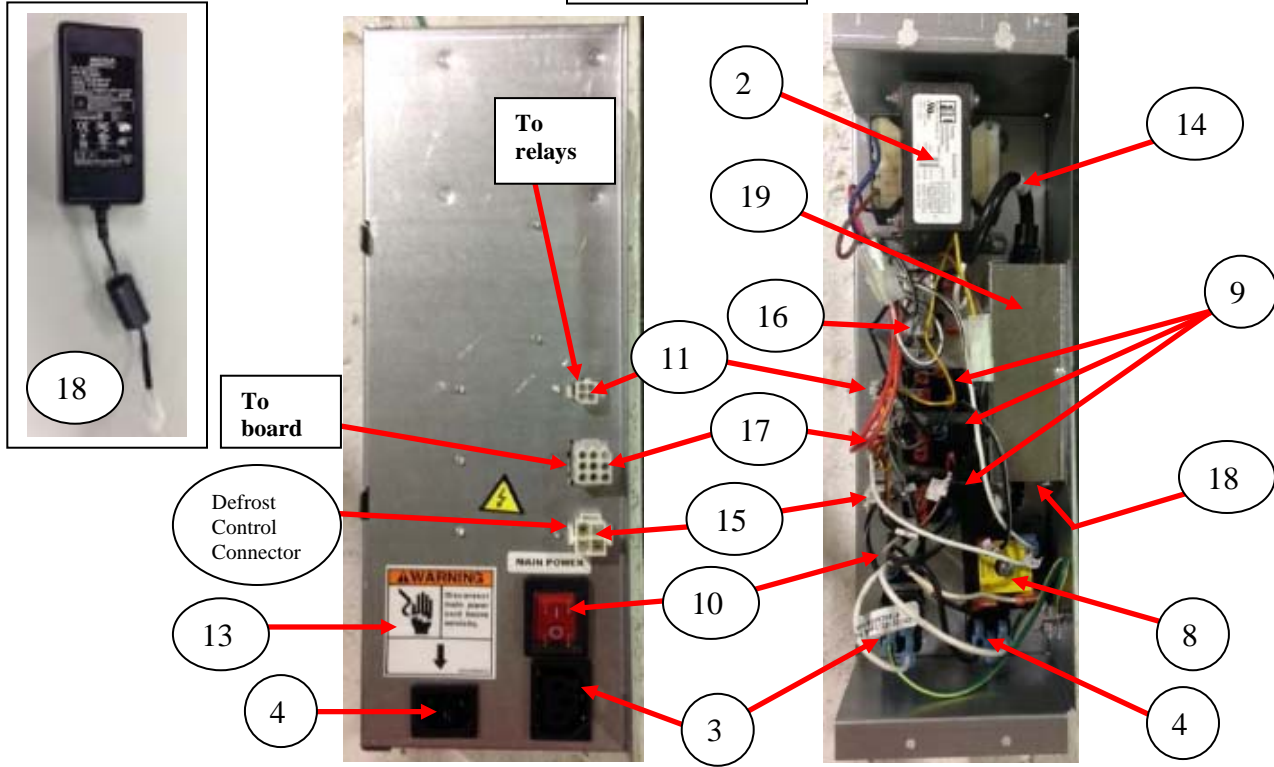

Domestic AC Box

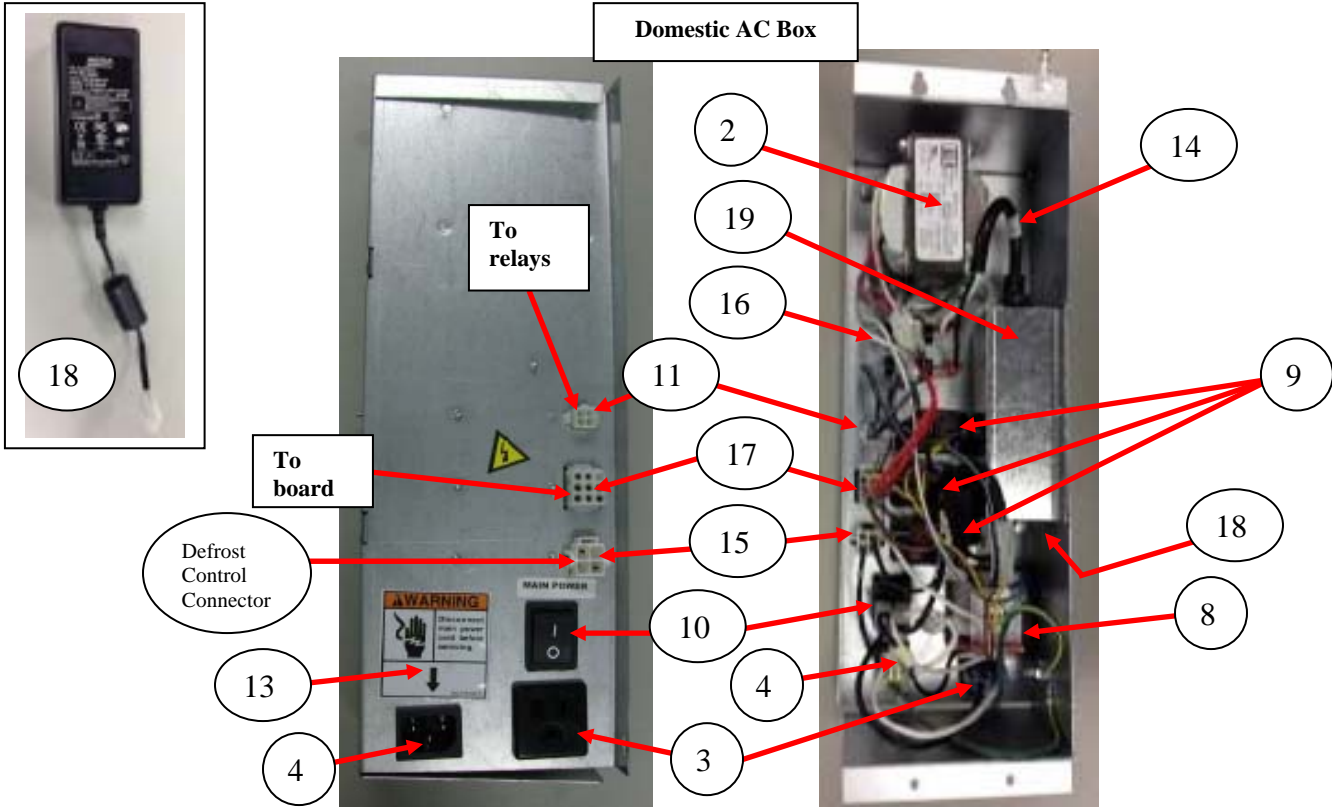

AC DISTRIBUTION BOX

ITEM	PART DESCRIPTION	DN5800-6 DN3800-6 Domestic	DN5800-E6 DN3800-E6 Export
1	Assembly AC Distribution Box, BevMax 6	CR0014464	CR0015324
2	Transformer, 120V / 24V, 60 Hz, 8A Domestic	*80492514	NA
	Transformer, Export	NA	*80492868
3	Outlet, 15 Amp, Grounded	*W662	NA
	Receptacle, Panel Mount IEC 320	NA	*80491114
4	Power Inlet Plug	*80491362	Same
5	Harness, AC Power In	*80492843	Same
6	Label, On/Off Rocker switch	80387972	Same
	Harness, Main Power – GFCI Inline	*65701080	NA
	Power Cord, UK	NA	*80492903
	Power Cord, Australia	NA	*80492905
7	Cord, Power Detachable Denmark	NA	*80492900
	Cord, Power Detachable Israel	NA	*80492902
	Cord, Power Detachable South Africa	NA	*80492904
	Cord, Power Detachable Europe Shuko	NA	*80492906
8	Choke	*80492692	*80492691
9	Relay – Fan, Compressor, and Light	*80420026	Same
10	Rocker Switch	9984642	80410112
11	Harness, Relay	CR0014576	Same
12	Main Power Label	80386085	Same
13	Label, AC Box Power Disconnect	*80387694	NA
	Label, AC Box Power Disconnect, German	NA	CR0015321
14	C13 Adapter with Flag Harness	CR0013971	
15	Harness, Compressor Power AC Box (connects to 80492871011)	*80492895	Same
16	Filter, Light	AP380303	Same
17	AC Box Harness	CR0014549	Same
18	Power Supply Harness 24V DC	CR0013899	Same
19	LED Power Supply Mounting Bracket	CR0021207	Same
20			
21			
22			
23			
24			
Part numbers & descriptions are subject to change without notice. NA = Not applicable TBD = To be determined RB = Replaced by *Part used in BevMax 6 and BevMax 4 Venders.			

LIGHTING - LED

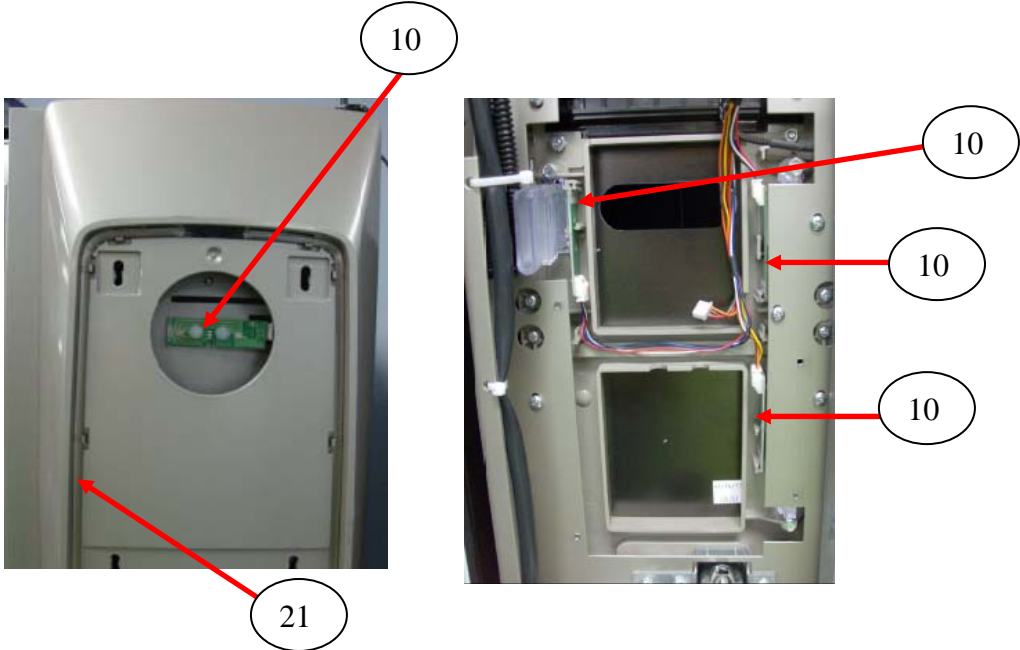
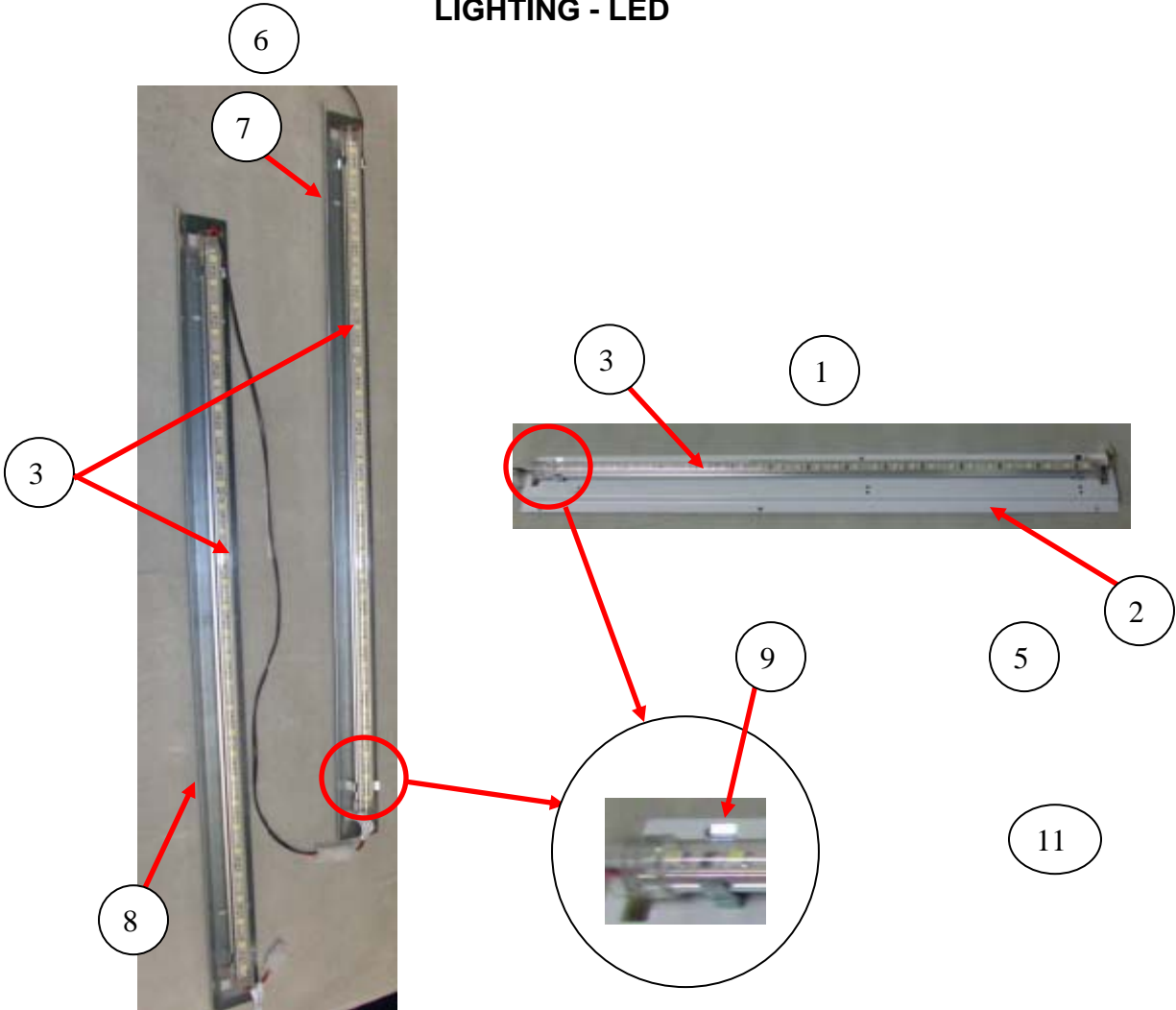

**REFRIGERATION UNIT BevMax 6
(with Plastic Evap Box)**

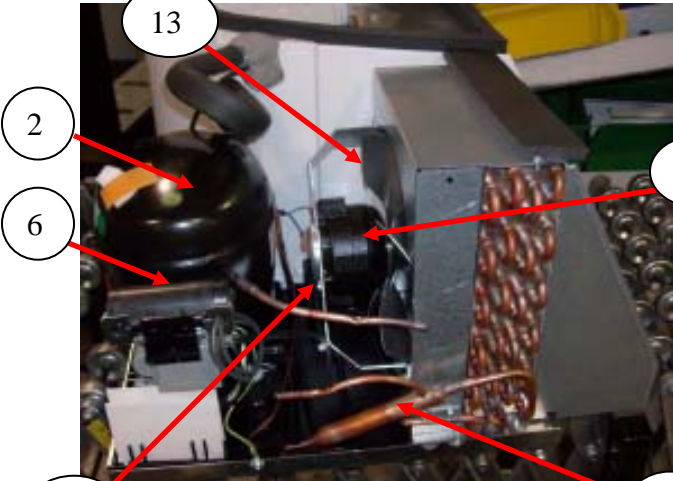
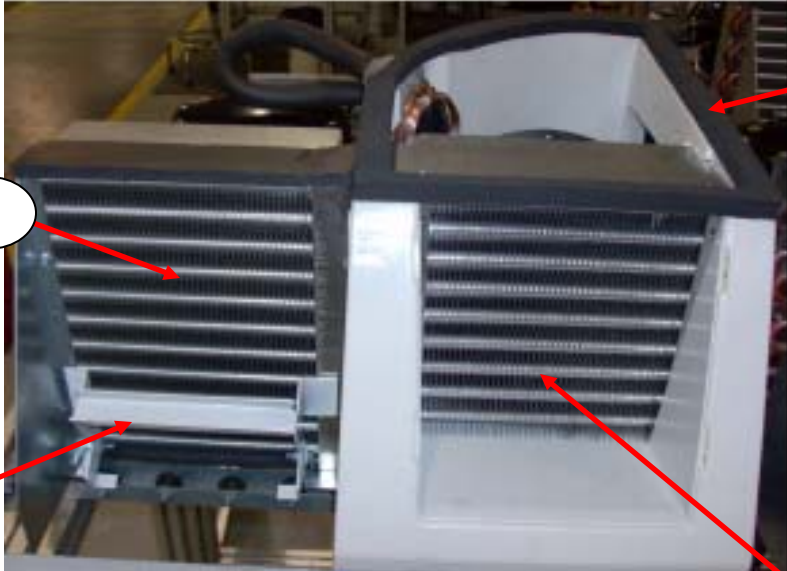

**REFRIGERATION UNIT BevMax 6
(with Plastic Evap. Box)**

ITEM	PART DESCRIPTION	DN5800-6/3800-6 Domestic	DN5800-E6/3800-E6 Export
1A	Refrigeration Unit, 115V/60Hz Domestic Kit (Plastic Evap Box)	*65701270	NA
	Refrigeration Unit, 230V/50Hz Export Kit (plastic Evap Box)	NA	*65701290
2	Compressor Assy. FFU130HAX , 115V/60Hz Domestic (1/3HP)	*80250289	NA
2A	Compressor, Domestic (Embraco 513200620)	*80250288	NA
2B	Compressor, Export	NA	*CR0004162
3A	Overload, 115V Domestic (EM# 513554617)	*80240213	NA
4A	Relay, 110V –Domestic (EM# 213516051)	*80240216	NA
4B	Relay, 220V –Export	NA	*CR0004863
5	Cover, Electrical	*80240214	*CR0004172
6A	Start Capacitor, 110V – Domestic (EM# 3252378)	*80240218	NA
6B	Start Capacitor, 250V/50Hz Export	NA	*CR0004174
7	Start Capacitor, End Cap Bottom Hole	*80240220	NA
8	Bracket, Capacitor	*80240217	NA
9	Drain Pan, Condensate – does not include soakers	*CR0002072	Same
10A	Assembly Condenser Fan, Domestic	*CR0005719	NA
10B	Assembly Condenser Fan , 220V, 16W, 10” Export	NA	*CR0004747
11A	Condenser Fan Motor, 9W Domestic was 80450193	*80450187	NA
11B	Condenser Fan Motor, Export 16W	NA	*CR0004145
12	Silencer	*80210052	Same
13	Fan Blade, Condenser	*80130866	*CR0004748
14	Speed Nut	*80080199	Same
15	Condenser Coil	*CR0010358	Same
16	Dryer	*80240129	Same
17	Grommet Compressor	*90200057	Same
18	Evaporator Coil	*CR0004391	Same
19	Accumulator	*80240046	Same
20	Encapsulated Temperature Sensor	*80492821	Same
21	Assembly Evaporator Fan 115V Energy Star (5 blade)	*80450154	NA
	Assembly Evaporator Fan 230V/50Hz (5 blade)	NA	*CR0004783
22	Evaporator Fan, 115V	*80450151	NA
	Evaporator Fan, EBM (5 blade) 220-230/50 includes harness	NA	*CR0004180
23	Defrost Control	*CR0002421	Same
24	Evaporator Drain Pan Assy.	NA	Same
25	Condensate Drain P Trap	*CR0002026	Same
26	Deck Handle Clamp	*CR0002304	Same
27	Soaker	*90580069	Same
28	Gasket Assembly – includes: A – CR0002551 Top Evaporator; B – CR0002552 Right side Evaporator; C – CR0005730 Lower Right side air gasket	*CR0002615	Same
29	Refrigeration Deck Clamp	*CR0002203	Same
30	Grill, Plastic	*CR0007259	Same

Part numbers & descriptions are subject to change without notice.
NA = Not applicable TBD = To be determined RB = Replaced by
*Part used in BevMax 6 and BevMax 4 Venders.

ELECTRONICS

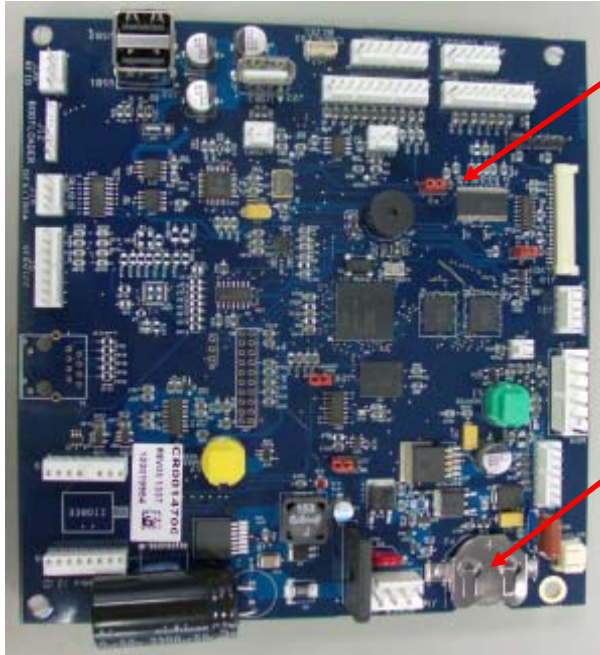

BevMax 6 Atlas Control Boards

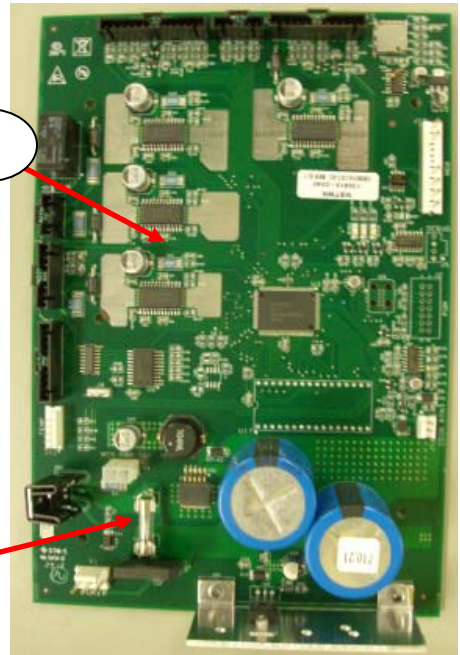

BevMax 6 I/O Control Boards

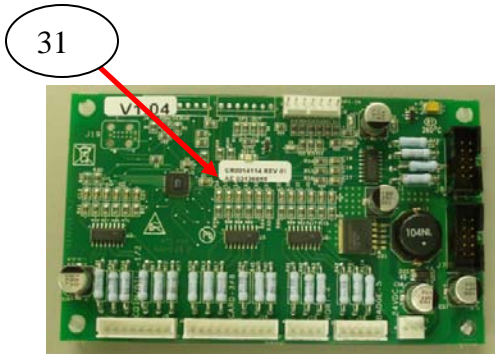

BevMax 6 PCB LED Driver Board

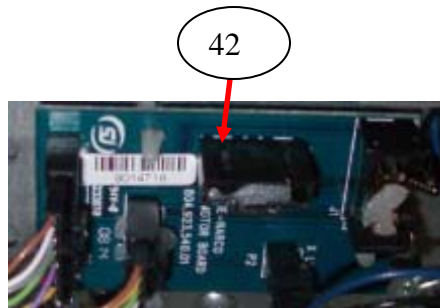

Y Board

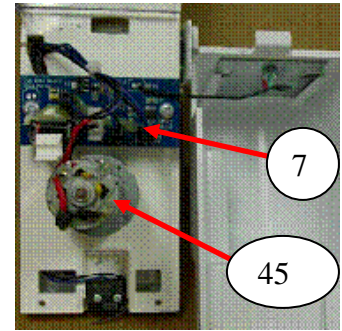

Delivery Cup Board



Touch Screen

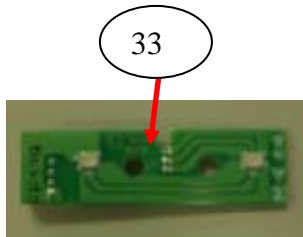

PCB LED Assy.

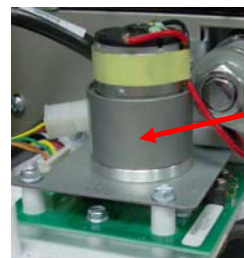

Port Assy. Board

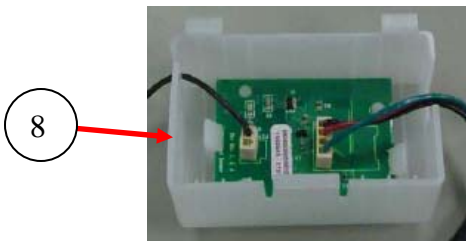

Vend Sensor Assy.



Coin Return Motor

ELECTRONICS

ITEM	PART DESCRIPTION	DN5800-6 DN5800-E6	DN3800-6 DN3800-E6
1	BevMax 6 Atlas Control Board (7 Inch Touch, does not include software)	CR0022933	Same
2	Standoffs, .8 – 32 x 5/8 (was 80100175)	*80190380	Same
3	Transformer – Domestic (not shown, see AC Box))	*80492514	Same
	Transformer – Export (not shown, see AC Box)	*80492868	Same
4	Battery, 3 Volt Lithium (CR20332)	80492045	Same
5	Encapsulated Temperature Sensor (not shown see Harnesses A)	*80492821	Same
6	Choke, Evaporator Fan Assembly & Lighting/AC Dist. Box – Domestic	*80492692	Same
	Choke, Evaporator Fan Assembly & Lighting/AC Dist. Box – Export	*80492691	Same
7	Delivery (Picker) Cup Base Board	*80492959	Same
8	Port Vend Sensor with Harness Assy.	*CR0003022	Same
9	Relay – Fan, Compressor, & Light (see AC Box)	*80420026	Same
10	Atlas Board Cover (see Service Door A)	CR0012802	Same
13			
14			
21	PCB Cold Drink I/O Board Assy.	CR0014121	Same
22	Standoffs, .8-32 X 5/8	80190380	Same
23	Control Board Bracket Assy.	CR0001982	Same
24	I/O Board Controller Cover	CR0001619	Same
25	Fuse, 3 Amp 5 X 20mm Sloblo (on Control Board)	80480116	Same
31	LED Driver Board Assy.	CR0014114	Same
32	Standoffs, .8-32 X 5/8	80190380	Same
33	PCB LED Assy.	CR0014123	Same
41	7 Inch Touch Screen Display	CR0021510	Same
42	Y Motor Board	*80492532	Same
43	Coupling Motor (Electronic Coin Return)	4407712	Same
44	Motor, Short (Port only)	CR0012833	CR0012833
45	Delivery Cup Motor	*80450161	Same
46	XY Motor (Planetary) (see XY Motor Picker Unit)	*80450189	Same
Part numbers & descriptions are subject to change without notice. NA = Not applicable TBD = To be determined RB = Replaced by *Part used in BevMax 6 and BevMax 4 Venders.			

HARNESSES

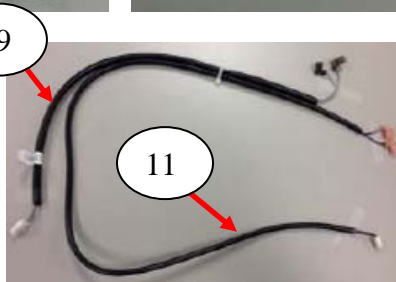
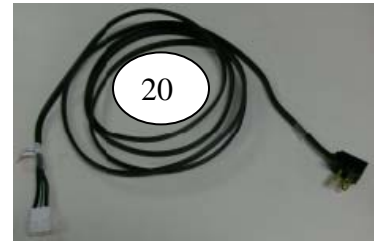
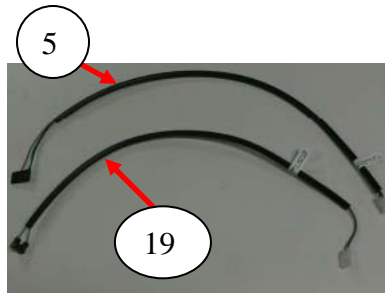
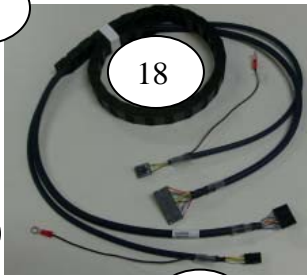
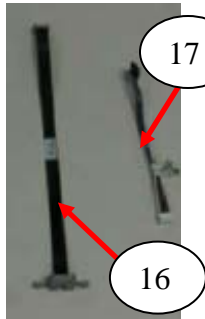
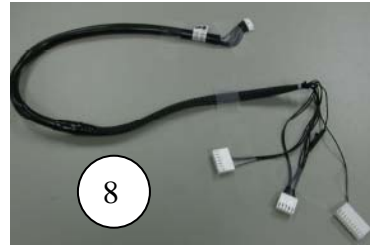
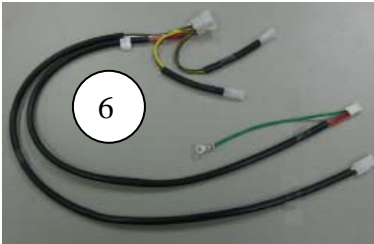

HARNESSES (B)

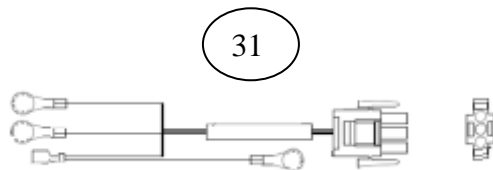
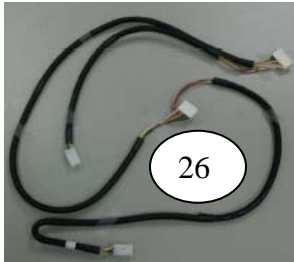
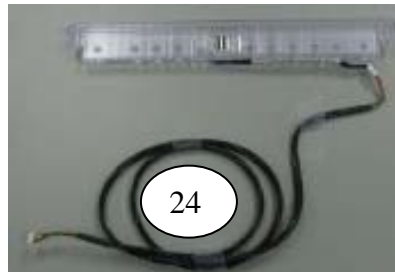
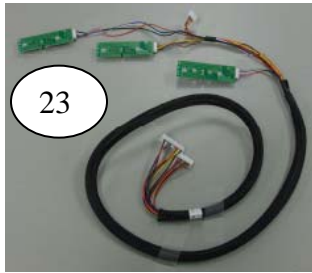

ITEM	PART DESCRIPTION	FROM/TO	DN5800-6 DN5800-E6	DN3800-6 DN3800-E6
23	Harness, LED Bundle	10 pin white socket to J16 and 8 pin white socket to J9 of LED Driver board, 4 pin white sockets to PCB LED assemblies at coin insert slot, bill validator opening, 2 at cashless opening.	CR0015428	Same
24	Harness, Card reader Media	5 pin white connector at J42 Atlas board to 5 pin connector of cashless bezel mag head	CR0014363	Same
25	Harness, LED Controller Power	2 pin white plug to CR0014596 (Interior Power harness), 3 pin socket to J1 of LED Driver board assy	CR0013189	Same
26	Harness, MDB Media	6 pin connector to J14 of Atlas board to 6 pin connector of coin mech, 8 pin connector to J18 of I/O board	CR0013989	Same
27	Harness, Relay AC Box Global	4 pin cap to relay harness, compressor relay, fan relay, light relay, not shown	CR0014576	Same
28	Harness, AC Box Power Distribution	9 pin cap to relays, transformer, choke, not shown	CR0014549	Same
29	Harness, Compressor Power	4 pin socket in AC Box to 2 spade terminals that go to relay coils & rocker (on/off) switch, not shown	80492895	Same
30	Harness, Port Motor & Sensor	12 pin connector to P2 of I/O Board, 7 pin connector to Port Board, 4 pin plug to Vend Sensor Harness.	CR0013265	Same
31	Harness, Compressor Extension 12" long	3 "U" shaped connectors from overload/relay to 3 pin white socket to item 28	80492980	Same

Part numbers & descriptions are subject to change without notice.
 NA = Not applicable TBD = To be determined RB = Replaced by
 *Part used in BevMax 6 and BevMax 4 Venders.

LABELS / DECALS / MISC.

Note: Graphics change frequently.

Contact your Crane Merchandising Systems Representative for current graphic parts & part numbers.

ITEM	PART DESCRIPTION	DN5800-6 DN5800-E6	DN3800-6 DN3800-E6
1	Thermometer	*80140155	Same
2	Price Sheet .35 – 1.10	*80387751	Same
	Price Sheet 1.15 – 1.85	*80387752	Same
	Price Sheet 1.90 – 3.75	*80387753	Same
3	Label, Selection - BevMax 6 (101 to 509)	*CR0017528	Same
4	Label, Warning "DO NOT TILT"	*80386829	Same
5	Programming Card, Quick Reference	TBD	Same
6	Label, On/Off Rocker Switch	*80387972	Same
7	Decal, Side Cabinet – Black	*W215	Same
8	Decal , Glass Door – Black	*80388984	*80388983
	Decal , Glass Door – Euro Gray	*80388852	*80388856
9	Decal, Cup Base – Black	*80388586	Same
10	Decal, Sleeve – Black Straight	80388487	Same
11	Wiring Diagram, Domestic LED Lighting	TBD	TBD
	Wiring Diagram, Export LED Lighting	TBD	TBD
12A	BevMax Media Parts Manual	TBD	Same
12B	BevMax Media Users Guide	TBD	Same
13	Generic BevMax 6 Manual, Installation SetUp Guide	TBD	Same
14	Decal, Glass Door Wear Strip	*80387837	Same
15	Label, Factory XY Settings	80388804	Same
16	Label, Warning Ramp	*80388543	Same
17	Shipping Bracket & Bolt Instruction Sheet	*80390443	Same
18	Cord, Power Detachable Denmark	*80492900	Same
	Cord, Power Detachable Israel	*80492902	Same
	Cord, Power Detachable South Africa	*80492904	Same
	Cord, Power Detachable Australia	*80492905	Same
	Cord, Power Detachable Europe Shuko	*80492906	Same
19	Decal, Glass Door Wear Strip	*80387837	Same
20	Label, Warning Ramp	*80388543	Same
21			

Part numbers & descriptions are subject to change without notice.
 NA = Not applicable TBD = To be determined RB = Replaced by
 *Part used in BevMax 6 and BevMax 4 Venders.
 Contact Dixie Narco for other available graphics.

Screws

(diagrams are for shape reference only)

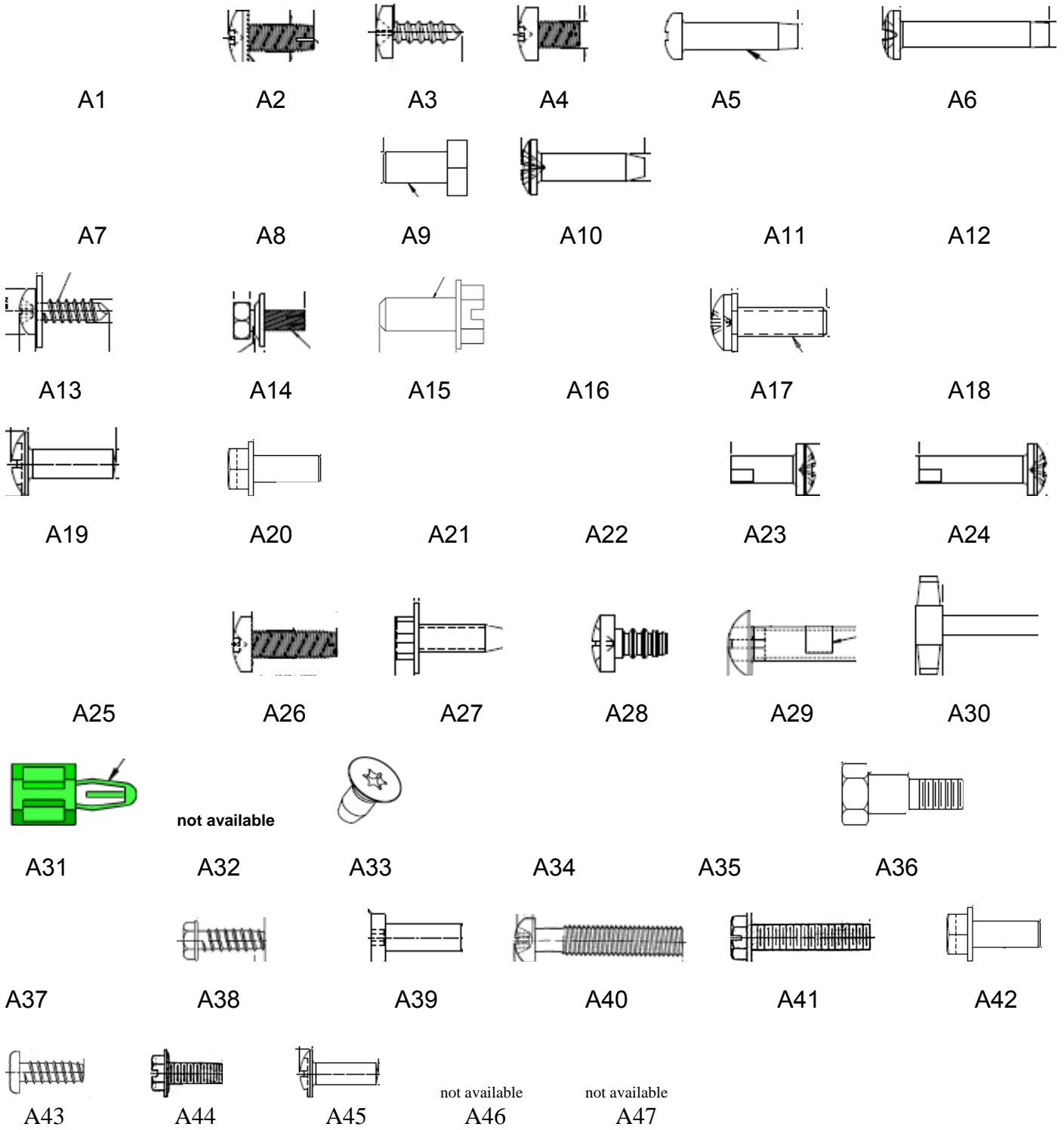

SCREWS

ITEM	PART NUMBER	PART NAME AND DESCRIPTION
A1		
A2	*80030422	Screw, Phil Pan #8 - 32 x 3/8"
A3	*80030418	Screw, Phil Pan w/out washer self drilling, #8 - 18 x 1/2"
A4	*80030434	Screw, Phil Pan Swage Form #8 - 32 x 1/4"
A5	*80030499	Screw, Phil Pan #2-32 x 3/8"
A6	*80030501	Screw, Phil Pan, #2-32 x 1/2"
A7		
A8		
A9	*80020284	Screw, Hex Head 1/4-28 X .5
A10	*80030494	Screw, Phil Pan #8 - 32 x 5/8"
A11		
A12		
A13	*80030423	Screw, Phil Pan Sems with washer, #8 - 18 x 1/2"
A14	*80030436	Screw, Self Tapping, 1/4 - 20 x 5/8"
A15	*80030468	Screw, Hex Washer 8x5/8"
A16		
A17	*80030503	Screw, Phil Pan with lock washer #4 - 40 x 3/8"
A18		
A19	*80030431	Screw, Phil Pan #8-18x1/2"
A20	80030454	Screw, Hex Head 10-16x .50
A21		
A22		
A23	*80030497	Screw, Phil Pan #8-18x.375"
A24	*80030502	Screw, Phil Pan #8-18x5/8"
A25		
A26	*80030421	Screw, Phil Pan Swage Form #8-32x1/2"
A27	*80030451	Screw, Hex Washer Head #8-18x1/2"
A28	*80020248	Screw, Pan Head #6-32 X 1/4
A29	80030415	Screw, Nylock #8-32x1/2"
A30	*80030529	Screw, Wing 1/4 - 20 x 1 1/4 molded nylon (for shipping bracket)
A31	CR0002205	Screw, Nylon (Circuit Board Support – Display)
A32	*80030541	Screw, TEK Zinc #20 X .750
A33	*AP13100035	Screw, Fl. Torx Tap 1/4-20 X 1/2
A34		
A35		
A36	*80050387	Screw, Shoulder 1/4-20 X .35
A37		
A38	*1572269	Screw, Hex w/ Head, Hi-Lo #6 X 1/2
A39	*80020250	Screw, Hex Button Head 10-32 X 5/8
A40	*80020285	Screw, 10-32 X 1.375
A41	**1457027	Screw, Hex Head 8-32 X .81
A42	**80030438	Screw, Hex w/ Washer 8-32 X 3/8
A43	**4277042	Screw, TIF PHS 8-10 X .5
A44	**3157060	Screw, Hex w/ Head #8-32 X .31
A45	**80030492	Screw, Phil Pan Zinc 8-32 X 1
A46	**1471199	Screw, Hex w/ Washer #8-18 X .62
A47	80030539	Screw, Mounting Condenser Motor

Part numbers & descriptions are subject to change without notice.
 NA = Not applicable TBD = To be determined RB = Replaced by
 *Part used in BevMax 6 and BevMax 4 Venders.
 **Part used in BevMax 6 only.

NUTS, WASHERS, BOLTS, & MISC. HARDWARE
 (diagrams are for shape reference only)

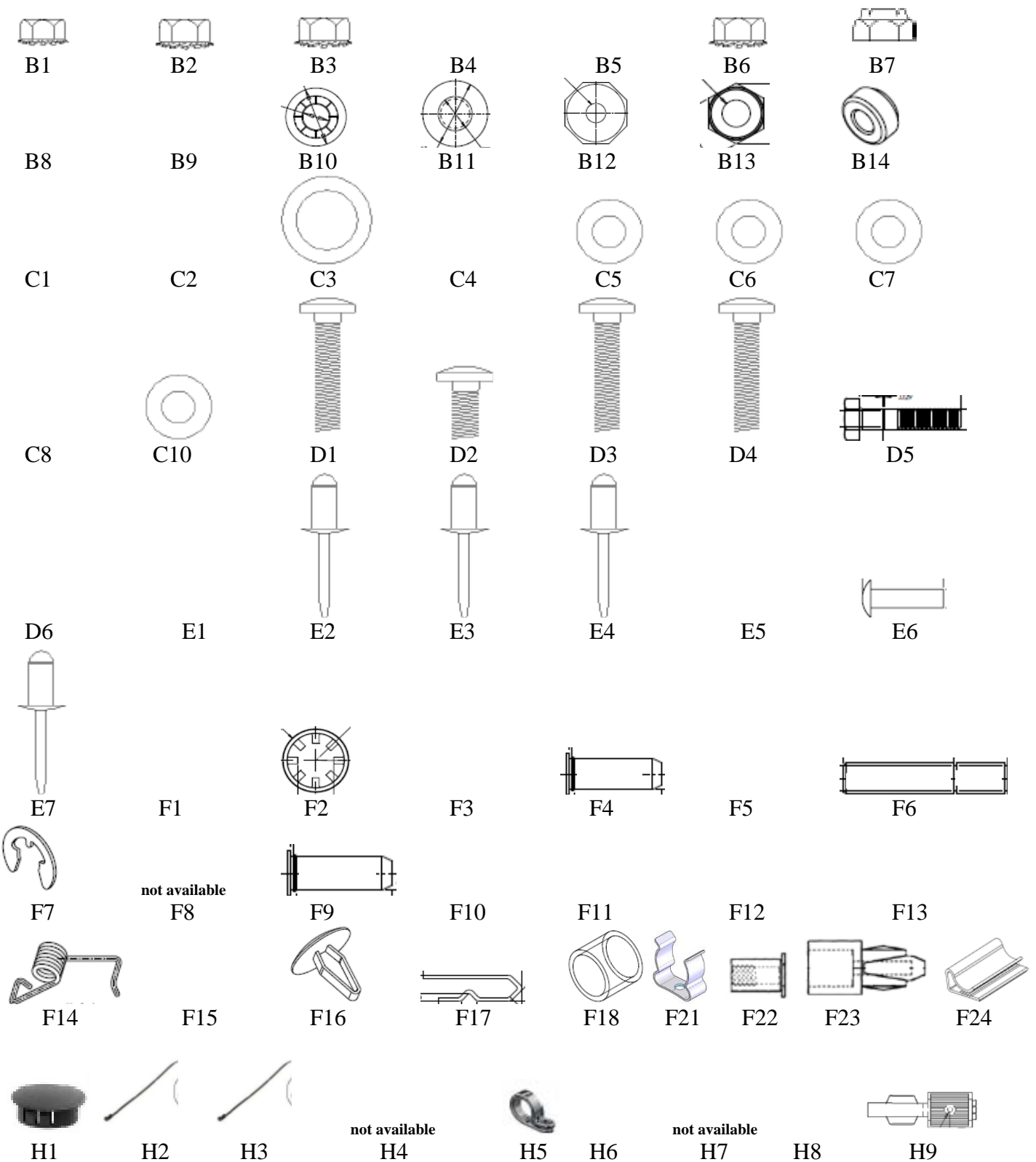

WASHERS, BOLTS, & MISC. HARDWARE

ITEM	PART #	PART NAME AND DESCRIPTION	ITEM	PART #	PART NAME AND DESCRIPTION
B1	*80080156	Hex Nut, #10 - 32	E1		
B2	*80080157	Hex Nut, 1/4 - 20	E2	*80110081	Pop Rivet, Steel (Zinc Plated) 1/8"
B3	*80080154	Hex Nut, #8 - 32	E3	*80110079	Pop Rivet, Steel (Zinc Plated) 3/16"
B4			E4	*80110065	Pop Rivet, Aluminum 1/8" White
B5			E5		
B6	*80080166	Hex Nut with washer, #10 - 24	E6	*19609043	Rivet, Bulbex 3/16 Black
B7	*80080155	Elastic Stop Nut, #8 - 32	E7	*80110066	Pop Rivet, Steel 3/16 Black
B8			E8	**90110053	Pop Rivet, Multigrip Blind
B9					
B10	*80090302	Push Nut ID .250	F1		
B11	*80080147	Push Nut Washer Cap Type	F2	*80090351	Retaining Ring
B12	*80030478	Nylon Insert Lock Nut 1/4 - 20	F3		
B13	*80080195	Nut, 10-32 Nylock	F4	*80100176	Pin Self Clinching .250 x 3/4
B14	*80080178	Nut, 1/4-20 Pemnut C420-1	F5	*80530053	Bushing, .5 X .691 X .187
B15	**80080199	Nut, Speed Cond. Motor	F6	**80050404	Pin Belt Tensioner Idler PVT
B16	**CR0004998	Nut, Machine Hex 1/4 - 28	F7	*80090336	E Ring Ext 1/4 #E-25
B17	**9900081	Nut, Hex Zinc #8 - 32	F8	*80190380	Standoff Richo RLCBSR401SR
			F9	*80100177	Pin Self Clinch .250 x 1
C1			F10		
C2			F11		
C3	*90070122	Washer, .260 ID x .687 OD Flat	F12		
C4			F13		
C5	*80070152	Washer, .191 ID x .5 OD x .054T Flat	F14	**80170163	Belt Tensioner Spring
C6	*48909130	Washer, SS Flat #10	F15		
C7	*80070144	Washer, Flat 18 Gauge 17/64ID x 5/8OD	F16	*80090361	Clip, Canoe Natural (Lens)
C8			F17	*90090188	Clip, Retainer Compressor
C9			F18	80530071	Spacer, 1/4ID X .275
C10	80182428	Washer, Nylon .375	F19		
			F20	**W789	Cotter Pin .076 X .500
D1	*80020249	Bolt, Carriage 1/4 - 20 x 2.5	F21	**1672173	Steel Spring Clip LED
D2			F22	1672045	Standoff Flush Head #6 - 32 X 3/8
D3	*CR0004761	Bolt, 1/4-20 X 1.75	F23	**1571034	Standoff Screw Mount PCB 3/8
D4	*80030542	Bolt, Carriage 1/4-20 X 2	F24	80181929	Clip, Flat Wire Heyco #3788
D5	*80040071	Bolt, Hex 1/4-20 X 1.25			
D6			H1	*AP420040	Plug, Dome Black .50
D7	**CR0012552	Bolt, Flange 1/4 - 20	H2	*90190201	Wire Tie, 7 1/2"
D8	**CR0010130	Bolt, Carriage #10 - 24 X 1 1/4	H3	*90190100	Wire Tie, 4"
			H4	*W223	Wire Tie, Twist
			H5	*80090251	Clamp, Nylon 5/16" White
			H6		
			H7	*CR0004146	Clamp, .250 Push Fin Base
			H8	**CR0014973	Velcro, 5.5 inch Low Profile

Part numbers & descriptions are subject to change without notice.
 NA = Not applicable TBD = To be determined RB = Replaced by
 *Part used in BevMax 6 and BevMax 4 Venders.
 **Part used in BevMax 6 only.