

Hot Drink Center

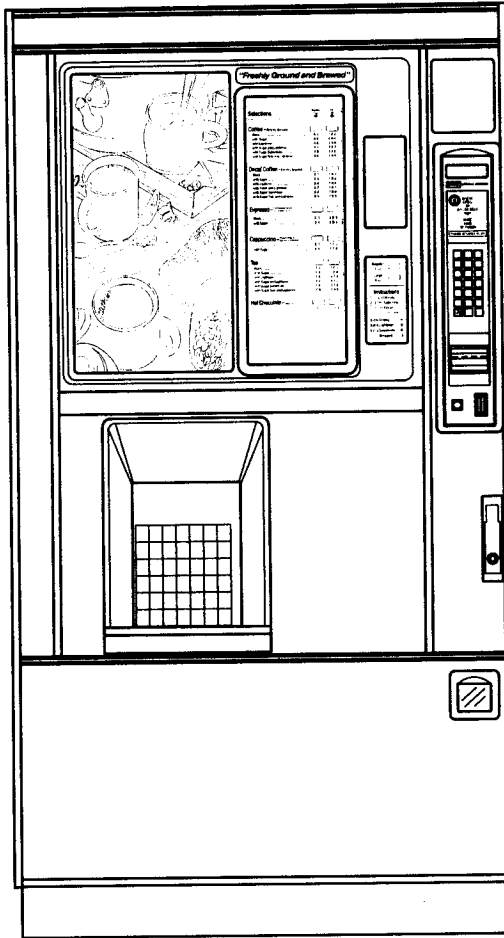

MODEL 633 - 635 - 637

Operator's Guide

Copyright © 7-98

CRANE- National Vendors 

6330096

This machine has been engineered to our own rigid safety and performance standards. It has been designed to comply with sanitation and health guidelines recommended by the Automatic Merchandising Health-Industry Council (AMHIC) and it conforms with all other NAMA safety recommendations.

This machine has been manufactured in accordance with the safety standards of both Underwriter's Laboratories and the Canadian Standards Association. To maintain this degree of safety and to continue to achieve the level of performance built into this machine, it is important that installation and maintenance be performed so as to not alter the original construction or wiring and that replacement parts are as specified in the Parts and Service Manual. Your investment in this equipment will be protected by using this Operator's Guide and the Parts and Service Manual in your operation, service and maintenance work. By following prescribed procedures, machine performance and safety will be preserved.

Copyright© 7-98
National Vendors
A Division of Crane Co





TABLE OF CONTENTS

TABLE OF CONTENTS

Specifications iv

Major Parts vi

 Door Assembly - Exterior vi

 Door Assembly - Interior vii

Controls and Indicators x

INITIAL SET-UP

I. Location Preparation 1

 Electrical Power Requirements 1

 Water Requirements 2

II. Positioning the Merchandiser 3

III. Connecting Everything 3

IV. Final Mechanical Preparation 4

 Level the Merchandiser 4

 Mount the Base Plate 5

 Install the Water Filter Cartridge 6

 Load the Optional Filter Paper 9

 Install the Optional Coin Box Lock 11

 Set up and Load the Coin Mechanism 11

 Fill the Tank 12

 Fill the Canisters 12

 Load Cups 13

 Tell the Machine About the Cup Size(s) 13

 Test the Machine 15

ADJUSTMENTS AND MINOR MAINTENANCE 17

 Water Valve Adjustment 17

 Cup Mechanism Adjustment 18

 Grinder Adjustment 19

 Disengaging the Grinder 20

 Canister Installation 20

PROGRAMMING THE HOT DRINK CENTER 21

 Getting Around 21

 The Service Keypad 21

 The Selection Switch Panel 21

 The Displays 23

 The Function Keys 24

 Other Keys 24

 Control Panel Switch Functions Explained 25

 Programming Flowcharts 26

 Programming Procedures 34

THE SUPERVISOR MODE 34

 Accessing Supervisor Mode 35

 Entering A New Supervisor Code 35

 Entering A Freevend Code 35

 Locking or Unlocking Mode or Payout Keys 36

 Setting Printer or DEX Options 36

 Lock Or Unlock Data Clearing Access 37

MACHINE CONFIGURATION STEPS

 Selecting Display Language 37

 Selecting Coin Mechanism and Options 38

 Selecting Bill Validator and Options 38

 Select Monetary Options 40

 Select Card Reader And Options 42

 Setting up Winner Mode 43

 Setting up Mug Discount 44

 Setting the Printer Baud Rate 44



| | |
|--|-----------|
| PRODUCT CONFIGURATION STEPS - CONTINUED | |
| Lock or Unlock Selections | 44 |
| Set Cup Sizes | 45 |
| Set Dry Product Throw Time | 46 |
| Set Sugar Throw Times | 46 |
| Set Lightener Throw Times | 46 |
| Set Sugar Substitute Throw Times | 47 |
| Set Water Throw Times | 47 |
| Set Steep Times | 47 |
| Set Air Compressor Running Time | 48 |
| Set End-of-Vend Delay Time | 48 |
| Set Whipper Options | 49 |
| Adjust Water Tank Temperature Setpoint | 49 |
| Set Ratio of Chocolate in Cappuccino | 50 |
| Set Brewer Rinse Time Interval | 50 |
| Set Mixing Bowl Rinse Time and Interval | 51 |
| Set Machine Configuration Code | 52 |
| Set up Active Selections | 54 |
| Set up the Cup Only Option | 54 |
| Set up Whip Options | 55 |
| Set up Delivery Door Options | 55 |
| SETTING THROWS | 56 |
| Collecting Dry Product Gram Throws | 57 |
| Dry Product Weight and Throw Time Factory Default Settings | 58 |
| SPECIALTY DRINK RECIPES | |
| Cappuccino Recipe | 60 |
| Caffé Latte Recipe | 64 |
| European Cappuccino | 65 |
| Collecting Water Throws | 66 |
| Water Throw Default Times and Volumes | 67 |
| PRICING | |
| Setting Prices for Individual Selections' | 68 |
| Set Price for a Cup Only | 69 |
| Set One Price for the Entire Machine | 69 |
| Set One Price for all Regular Size Drinks | 70 |
| Set One Price for all Large Size Drinks | 70 |
| TIME-OF-DAY STEPS | |
| Set the Time | 71 |
| Set the Day of the Week | 71 |
| Set the Date and the Year | 71 |
| Set the Time-of-Day Inhibited Vending | 72 |
| Set the Time-of-Day Free Vending | 72 |
| Set the Time-of-Day Discount Vending | 72 |
| TIME INTERVAL EDITING | 73 |
| Messages | |
| Select a Standby Message | 75 |
| Select an Out-of-Service Message | 75 |
| Select a Freevend Message | 76 |
| Edit Custom Messages | 77 |
| SERVICE AND TESTING OPERATIONS | |
| Test Vend Selections and Verify Credit Added | 79 |
| Test the Display | 79 |
| Test the Cup Mechanism | 80 |
| Test the Automatic Door | 80 |
| Test the Whippers | 80 |
| Test the Grinder | 81 |
| Test the Air Compressor | 81 |
| Test the Brewer | 82 |



| | |
|---|---------|
| Rinse all Mixing Bowls | 82 |
| Rinse the Brewer | 83 |
| Fill the Tank | 83 |
| Test Various Switches and Sensors | 84 |
| Payout Coins | 84 |
| MISCELLANEOUS | |
| Set Free Vend Options | 85 |
| View Machine ID Number | 85 |
| VIEWING DATA | |
| View Non-Resetable Sales and Vend Data | 86 |
| Data Viewing Mode | 86 |
| View Total Paid Sales | 86 |
| View Card Reader Sales | 87 |
| View Total Paid Vends | 87 |
| View Amount in the Coin Box | 88 |
| View Amount in the Validator | 88 |
| View Freevend Sales by Time Interval | 89 |
| View Discount Sales by Time Interval | 89 |
| View Free Vends | 89 |
| View Winners | 90 |
| View Time Data | 90 |
| View Total Unpaid Sales | 91 |
| View Total Unpaid Vends | 92 |
| View Number of Test Vends | 92 |
| View Sales Data by Price | 92 |
| CLEARING DATA | |
| Clear All Resetable Data | 87 |
| Clear Paid Sales Data Only | 88 |
| DIAGNOSTICS | |
| Display Diagnostic Messages | 93 |
| MACHINE IDENTIFICATION NUMBER | |
| Change Machine ID Number | 95 |
| VIEW OVERALL CONFIGURATION SETTINGS | |
| View Water Tank Temperature | 95 |
| View Correct Software Version Number | 95 |
| View the Machine Configuration Code | 95 |
| View the Selection Configuration | 96 |
| View Cup Only Status | 96 |
| View the Selected Whipping Option | 96 |
| View the Automatic Delivery Door Option | 96 |
| SANITATION | 97 |
| Basics | 97 |
| Sanitation Procedures | 99 |
| Overall Cleaning | 100 |
| Preventive Maintenance Cleaning | 100 |
| Appendix A. THE FREE VEND KEYSWITCH OPTION | A1 |
| APPENDIX B. THE INFRARED MUG/CUP SENSOR | B1 |
| APPENDIX C. DEX/UCS INTERFACE OPERATION | C1 |
| APPENDIX D. MODIFY CANISTER TO VEND 12 OZ. CUPS | D1 |
| APPENDIX E. CLEAN THE HOT WATER TANK | E1 |
| INDEX | Index 1 |



SPECIFICATIONS

SPECIFICATIONS COMMON TO ALL MACHINES

| | |
|---|--|
| DIMENSIONS | 72" (183 cm) high 38.12" (97 cm) wide 28.5" (72 cm) deep |
| WEIGHT | 570 lbs (258.5 kg) |
| WATER REQUIREMENTS | Minimum: 20 psi (137.8 kPa) Maximum: 80 psi (551.2 kPa) |
| AMBIENT TEMPERATURE | Minimum: 41 F (5 C) Maximum: 90 F (32 C) |
| OPERATING ENVIRONMENT | For indoor use only |
| CUP CAPACITIES (APPROXIMATE) | 7 oz cups (squat) - 1150 8.25 oz cups - 1050 9 oz cups (squat) - 1100 10 oz cups - 1000 12 oz cups - 940 |
| CANISTER CAPACITIES (APPROXIMATE) | Regular coffee beans - 14 lbs Ground coffee - 13 lbs Freeze dry coffee - 2 lbs Decaf coffee beans - 9.5 lbs Ground decaf coffee - 9 lbs Freeze dry decaf - 2 lbs Chocolate - 10 lbs Soup - 6.7 lbs Sugar - 11 lbs Lightener - 4.5 lbs Sugar substitute - 4 lbs Tea (freeze dry) - 1.5 lbs 6th product (freeze dry) - 6 lbs |
| PRODUCT OPTIONS | |
| Model 633 Fresh Brew | Up to eight selections of fresh brew regular and decaf coffee, freeze dried regular and decaf coffee, fresh brew and freeze dried tea, soup, chocolate, cappuccino, espresso, and caffè latte. |
| Model 635 Freeze Dried | Up to eight selections of freeze dried regular coffee, decaf coffee, tea, soup, chocolate, cappuccino, espresso, and caffè latte. |
| Model 637 Fresh Brew with Bean Grinder | Up to eight selections of fresh ground and brewed regular and decaf coffee, freeze dried regular and decaf coffee, fresh brew and freeze dried tea, soup, chocolate, cappuccino, espresso, and caffè latte. |



SPECIFICATIONS

SPECIFICATIONS COMMON TO ALL MACHINES (continued)

| OPTIONS AND ACCESSORIES | |
|--------------------------------|--|
| OPTIONS | Coffee brewer filter paper (5000 vends per roll) Coin box lock Base grille kit Automatic delivery door Flex Ace door lock and key Van Door lock and key Sugar substitute kit 6th product kit Cup/mug electronic sensor (cup hold switch kit) Snap-on ingredient canister extension sleeves (4 tall) Everpure water filter system CUNO water filter system Debit card validator Free vend keyswitch Data printer kit Ingredient Rinse tray |

SPECIFICATIONS UNIQUE TO 115 VOLT MACHINES

| ELECTRICAL | 115 Volts AC 60 Hertz 12 Amps Single phase |
|--------------------------------|--|
| OPTIONS AND ACCESSORIES | |
| COIN MECHANISM | MARS TRC-6000 COINTRON 3000 MARS TRC-6010XV (24 V) Maka/Conlux Model USPX-004 (24 V) Coin Acceptors Model 9302-LF (24 V) |
| BILL VALIDATORS | MARS VFM1 pulse MARS VFM3 serial MAKA pulse COINCO |

SPECIFICATIONS UNIQUE TO 220 - 240 VOLT MACHINES

| ELECTRICAL | 220-240 Volts AC 50 Hertz 10 Amps 2 kW Single phase |
|--------------------------------|---|
| OPTIONS AND ACCESSORIES | |
| COIN MECHANISM | Executive coin mechanism interface |



Major Parts

The diagrams on the following pages will acquaint you with the major parts of the Hot Drink Center. For more detailed information, please consult your PARTS MANUAL. If you do not have a PARTS MANUAL, contact National Vendors Parts Department.

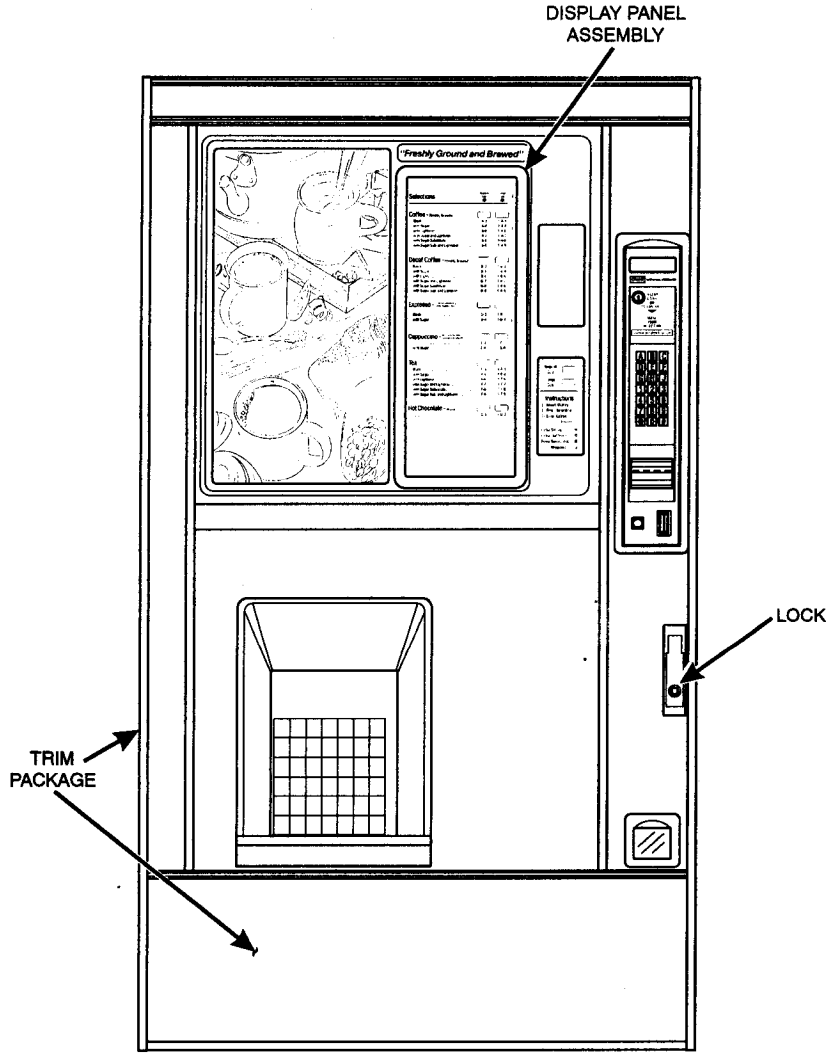

Door Assembly - Exterior

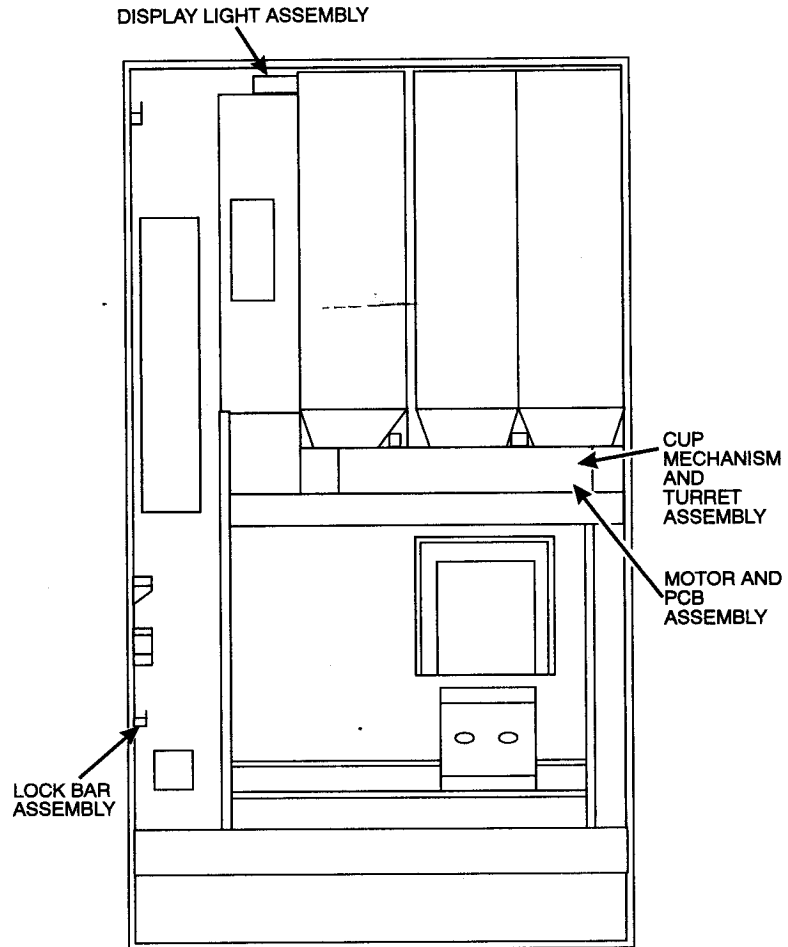

Door Assembly - Interior

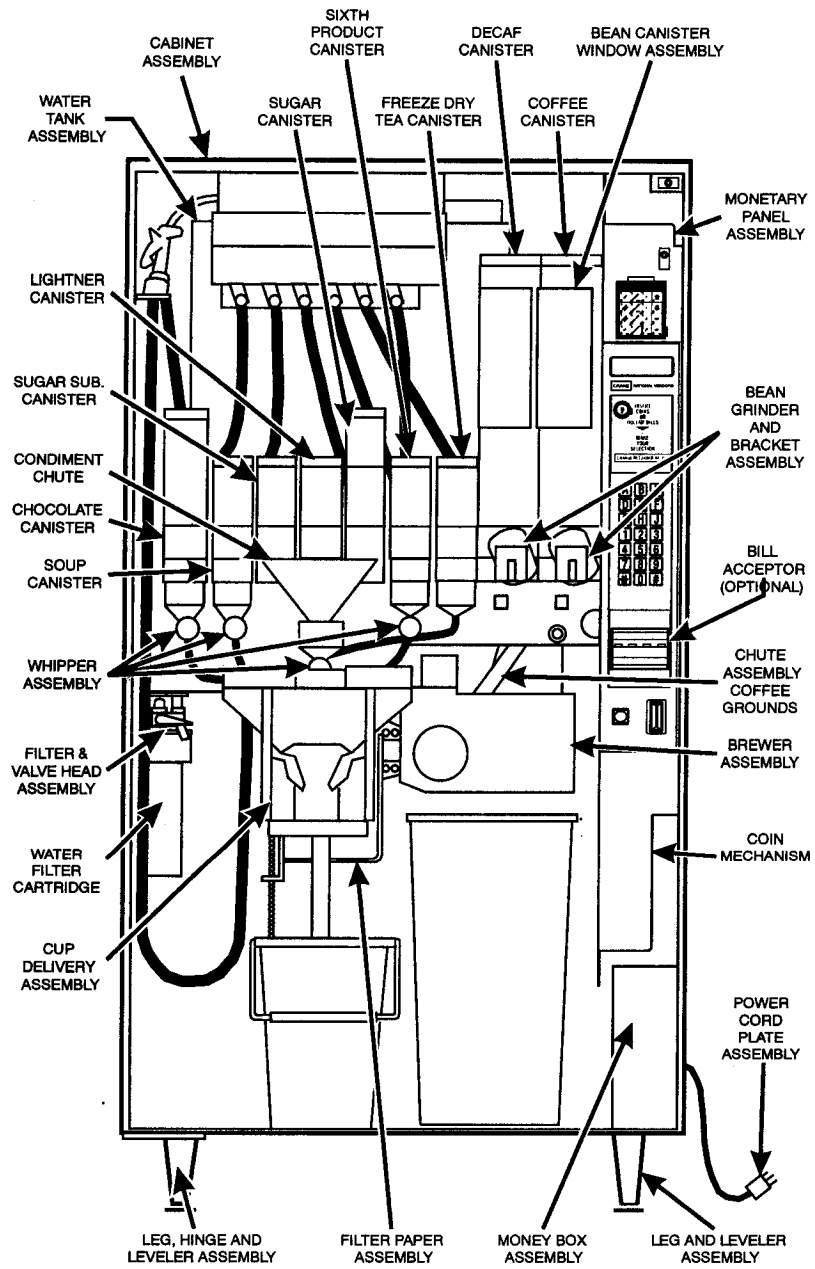

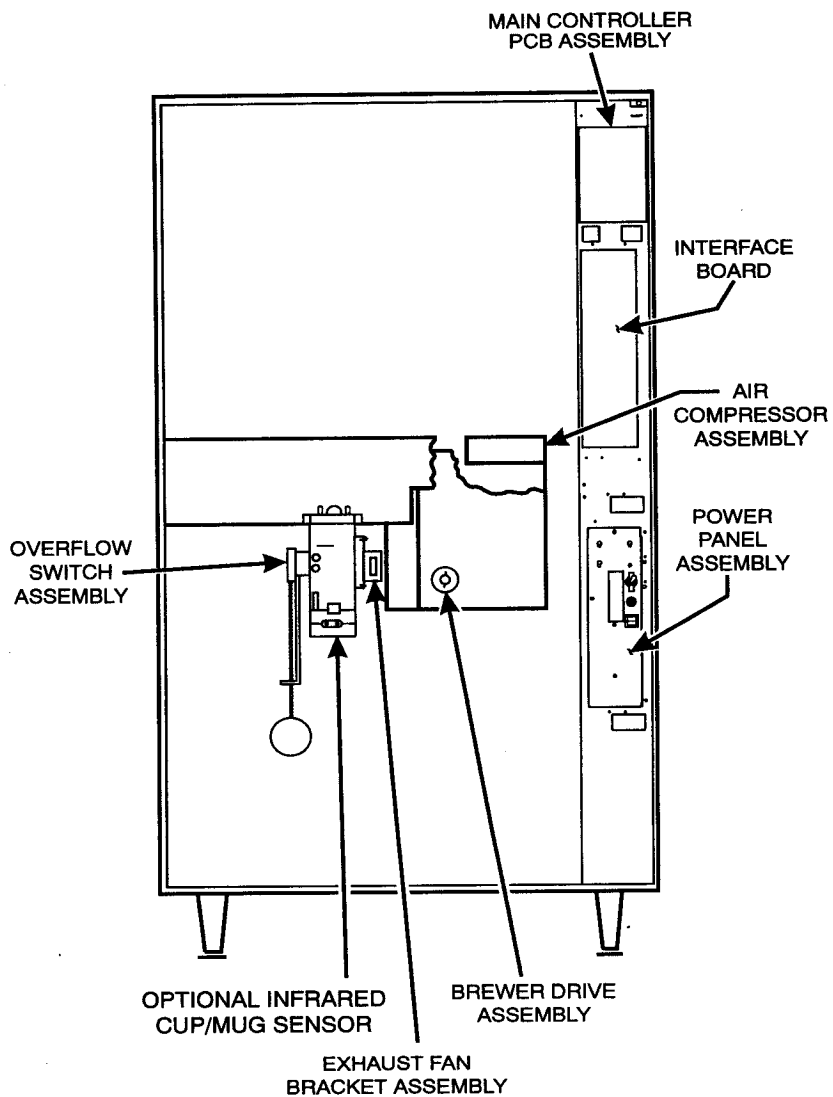



Controls and Indicators

POWER PANEL. You may have one of three power panels, depending upon where you live. The controls are fundamentally the same, however.

Circuit Breakers and Fuses. Circuit breakers and fuses protect the merchandiser against failures in the power supply or any of the electrical components. If a circuit breaker trips and cannot be reset, or if a fuse repeatedly blows, contact a field service representative.

Back Side of U.S./Canada Power Control Panel. The circuit board mounted on the rear of the U.S. and Canadian power control panel is a dc power supply for the coin mechanism. A fuse protects the board circuitry in the event of a coin mechanism solenoid failure. If the coin mechanism is not working, check this fuse. If the fuse is blown, a bad coin mechanism solenoid could be at fault.

Main Power Switch. This is the main ON/OFF switch for the merchandiser.

WARNING

To protect against electrical shocks and possible damage to the machine, turn this switch **OFF** when performing any maintenance on the merchandiser.

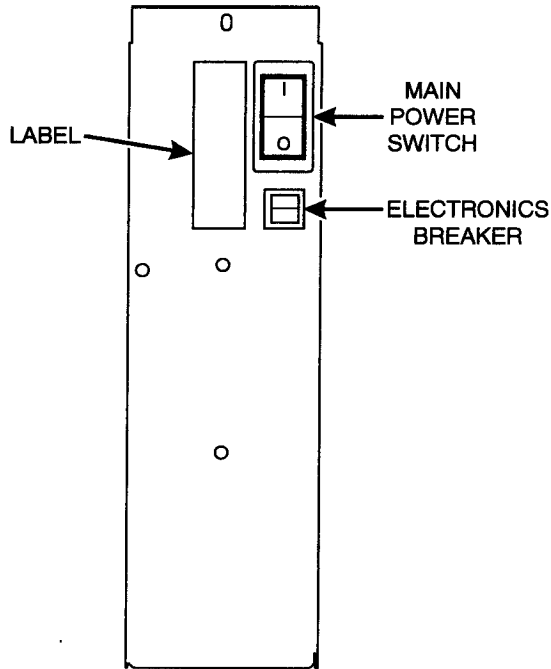

POWER CONTROL PANEL
(FRANCE / GERMANY / SPAIN)

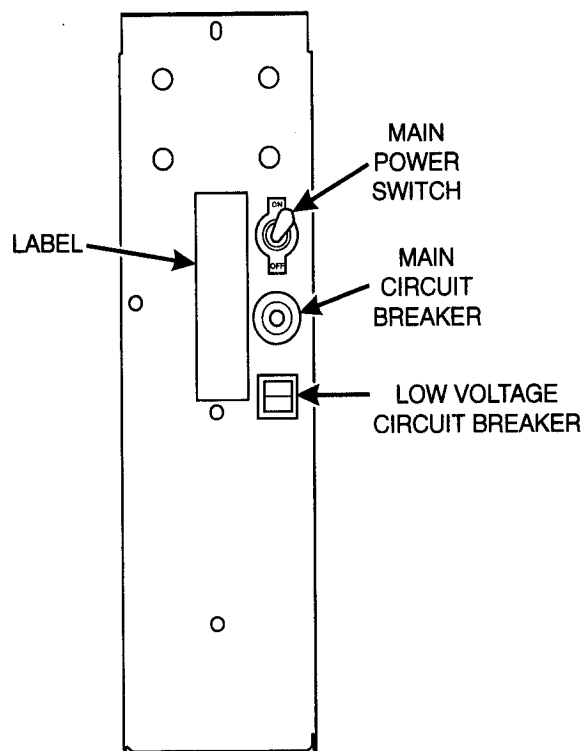

POWER CONTROL PANEL
(U.S. / CANADA)

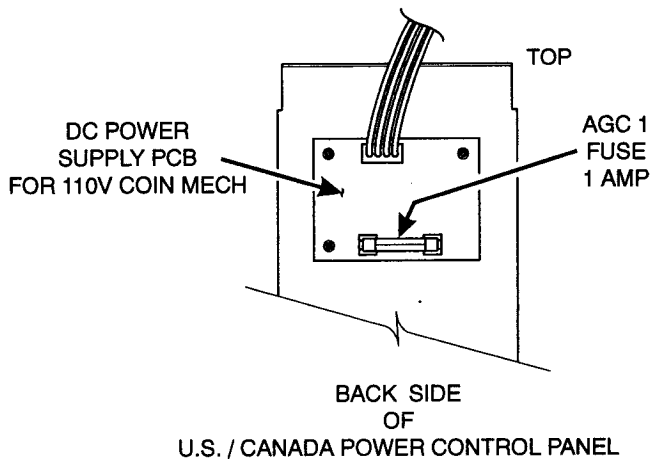

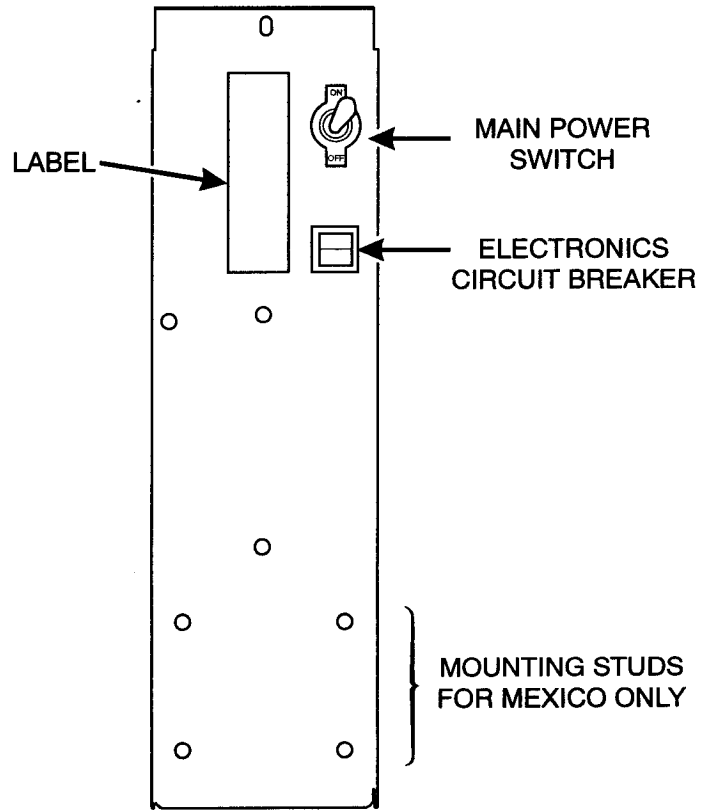

POWER CONTROL PANEL
(U.K. / MEXICO)

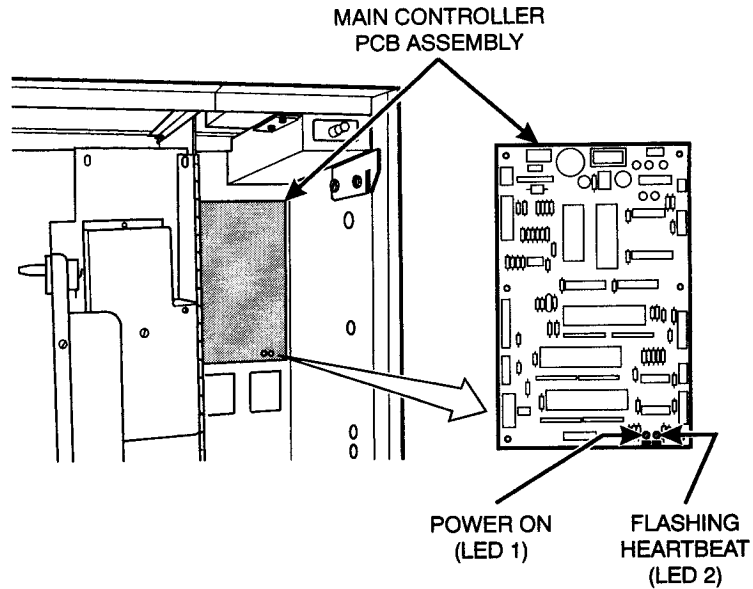

MAIN CONTROLLER PCB DISPLAY

Main Controller PCB Display. This display consists of two light emitting diodes (LED) mounted on the controller PCB.

POWER ON (LED 1)

When lit, this red LED indicates electrical power is applied to the controller PCB.

HEARTBEAT (LED 2)

When flashing, this red LED indicates that the controller PCB is active, and the software is operating.

NORMAL CONDITIONS:

When the merchandiser is operating normally, you should see a steady red **POWER ON** indicator. The red **HEARTBEAT** indicator should be flashing with a balanced on/off pattern (on for the same length of time that it is off).

ERROR CONDITIONS:

If an error is present, the red **HEARTBEAT** indicator will flash with an unbalanced on/off pattern (on longer than it is off). The error(s) can be viewed under the **DIAGNOSTICS** mode.

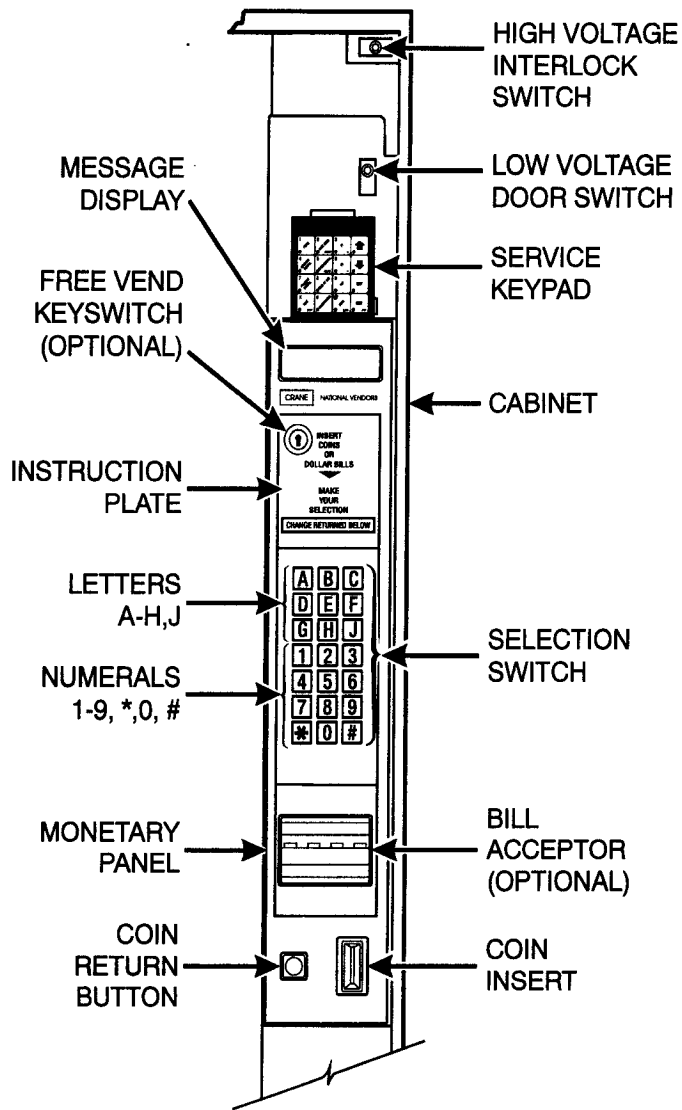



High Voltage Interlock Switch (U.S./ Canada). When the cabinet door is open, this switch turns off the optional fan and bean light (if so equipped) and turns on the service light.

High Voltage Interlock Switch (International). When the cabinet door is open, this switch turns off all high voltage to the cabinet. Pulling the switch out restores high voltage for maintenance purposes.

Low Voltage Door Switch. Informs the controller software of the main door open or closed status.

Message Display. This is how the merchandiser communicates with the outside world. Customers can see messages about how much money they have put into the merchandiser. The message display also tells customers when a selection is sold out and when vending is free, inhibited, or discounted. The message display shows you what you are doing when you program the merchandiser, and can show you what is wrong if there is a failure.

Free Vend Keyswitch. This allows someone (other than maintenance people) to set the merchandiser to free vend without opening the door.

Selection Switch Panel. The customer uses these switches to make selections. Also, maintenance people may use this switch panel during programming and other support modes.

Coin Return Button. Pressing this button returns any coins that have been paid into the merchandiser prior to a vend.

Bill Acceptor (Optional). Accepts bills in various denominations, depending upon the type of bill validator, and how the machine is configured.

Service Keypad. The service keypad is located at the top of the monetary panel. It gives service personnel the means to program, retrieve data from, and view diagnostic information about the merchandiser.

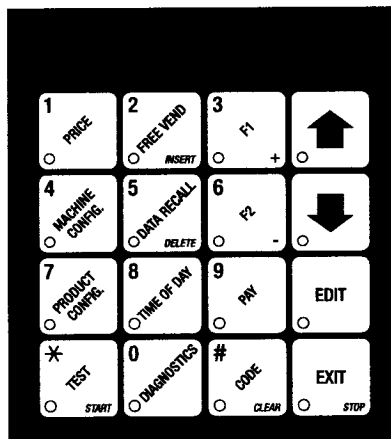

SERVICE KEYPAD



Pressure Adjust Control. This control determines the system pressure provided by the air compressor. Adjust the pressure as follows:

- a. With the compressor running, pinch the brewer inlet air tube.
- b. Adjust the pressure to read 10 - 12 psi on the gauge.

This will produce a pressure of 3 - 6 psi using regular coffee and 8¼ oz cups. No further air pressure adjustments should be necessary.

Pressure Gauge. This indicator shows the amount of air pressure in the system.

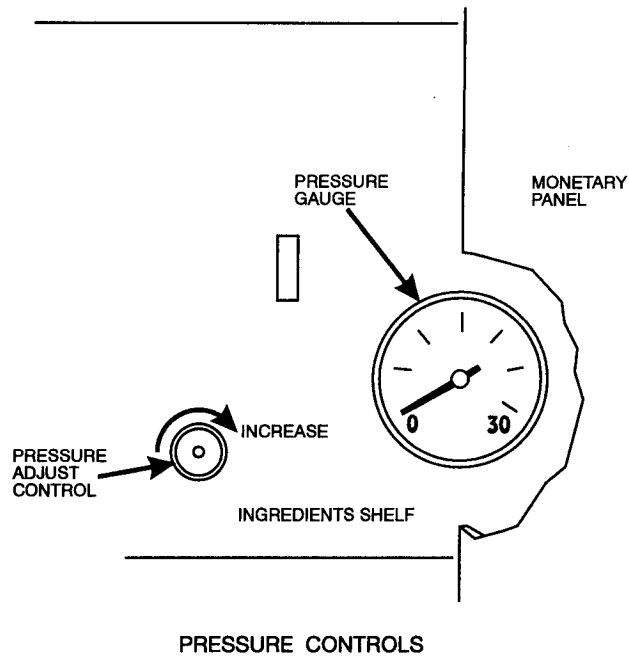



INITIAL SET-UP

I. LOCATION PREPARATION

After your machine is unpacked and placed near its permanent location, you need to make sure you have the proper electrical and water service.

ELECTRICAL POWER REQUIREMENTS

This merchandiser needs electrical power as shown in the following table. NOTE: Each merchandiser should have its own electrical circuit.

Power Requirements

| Country | Volts | Frequency (Hz) | Current (Amps) |
|----------------|-------|----------------|----------------|
| Canada | 115 | 60 | 15 |
| France | 230 | 50 | 10 |
| Germany | 230 | 50 | 10 |
| United Kingdom | 230 | 50 | 10 |
| United States | 115 | 60 | 15 |

This merchandiser is supplied with a service cord for the country of use and is terminated in a grounding type plug. The wall receptacle used for this merchandiser must be properly polarized, grounded, and of the correct voltage. Operating the merchandiser from a source of low voltage will **VOID YOUR WARRANTY**. Each merchandiser should have its own electrical circuit and that circuit should be protected with a circuit breaker or fuse conforming to local regulations.

Voltage Check - Place the leads of a voltmeter across the LINE (LIVE) and NEUTRAL terminals of the wall receptacle. The voltmeter should indicate 110-130 volts ac for 120 volt, 60 Hz locations, or 220-240 volts ac for 230 volt, 50 Hz locations.

Polarity Check - Place the leads of a voltmeter across the LINE (LIVE) and GROUND terminals of the wall receptacle. The voltmeter should indicate 110-130 volts ac for 120 volt, 60 Hz locations, or 220-240 volts ac for 230 volt, 50 Hz locations.

Noise Potential Check - Place the leads of a voltmeter across the NEUTRAL and GROUND terminals of the wall receptacle. The voltmeter should indicate 0 volts ac. A measurement greater than 1.5-2.0 volts ac could result in problems for the merchandiser's electronic circuitry caused by electrical noise.

Any deviation from these requirements could result in unreliable performance from your merchandiser.



WATER REQUIREMENTS

The best type of water for coffee brewing is normal hard (tap) water. If your location has chemically softened water, you should do one of the following things:

- Have a non-softened supply line run to the merchandiser
- Contact your local water filter supplier for information and suggestions

Well water can also be used in the Hot Drink Center. However, you should have it checked for levels of carbonates and alkalies. Contact your water filter supplier if these values are relatively high.

What is the Water Pressure at Your Location?

It should be no less than: 10 psi (69.0 KPa) at 1/2 gallon/minute
And no more than: 80 psi (522.0 KPa) at 1/2 gallon/minute

If you're not sure about the pressure and flow rate, check with your water company.

What to do With the Water Supply Line:

Locate the supply line at the rear of your merchandiser.
Equip the line with a shut-off valve.

Flush the water supply line before connecting it to the merchandiser. A minimum of five gallons is usually required before connecting the merchandiser to the supply line. **DO NOT** flush the merchandiser water system. If you do, you might introduce water line contaminants into the merchandiser.



II. POSITIONING THE MERCHANDISER

You can position this merchandiser anywhere in a bank of machines. It can even be placed on the end flush against a side wall. Be sure you leave enough room in front of the merchandiser for the door to move freely.

BE SURE THE REAR OF THE MERCHANDISER IS AT LEAST 6 INCHES (15 cm) AWAY FROM THE WALL. THIS WILL ALLOW WARM MOIST AIR TO BE VENTED OUT OF THE MACHINE'S INTERIOR.

WARNING:

THIS MACHINE IS ONLY RATED FOR INSTALLATION IN AN INDOOR LOCATION.

III. CONNECTING EVERYTHING

1. Connect the Merchandiser to the Water Supply:

- a. You will need the following:
 - A coil of copper tubing with outside diameter of 3/8 inch (9.5 mm) or greater. The appropriate plastic tubing may be substituted. The tubing must be long enough to reach from the water source to your machine with enough left over to form a loop about 2 feet (60 cm) in diameter. This will allow you to move the machine without straining the water line.
 - A 3/8 inch (9.5 mm) flare fitting.
- b. Connect the merchandiser to your water supply.

2. Connect the Merchandiser to the Electrical Power Supply:

Power inside the merchandiser is controlled by the main power switch, located on the power panel.

- a. Make sure the main power switch is OFF.
- b. Connect the merchandiser's power cord to your wall outlet.



IV. FINAL MECHANICAL PREPARATION

1. Level the Merchandiser:

- Place a spirit level on the top front edge of the cabinet with the door fully closed. Adjust the front legs only until the cabinet is reasonably level.
- Hold the door open about 4 inches.

WARNING

HAVE AN ASSISTANT HOLD THE MERCHANDISER WHILE YOU ADJUST THE LEG LEVELERS.

- Adjust the back legs so that the back leg leveler on the hinge side is off the floor just enough so a piece of paper can slide under it with only a bit of resistance.
- For proper weight distribution on all four legs, raise the back leg on the hinge side by unscrewing the leveler $1\frac{1}{2}$ turns.

NOTE

You may need to use pliers or channel locks to loosen the leg levelers.

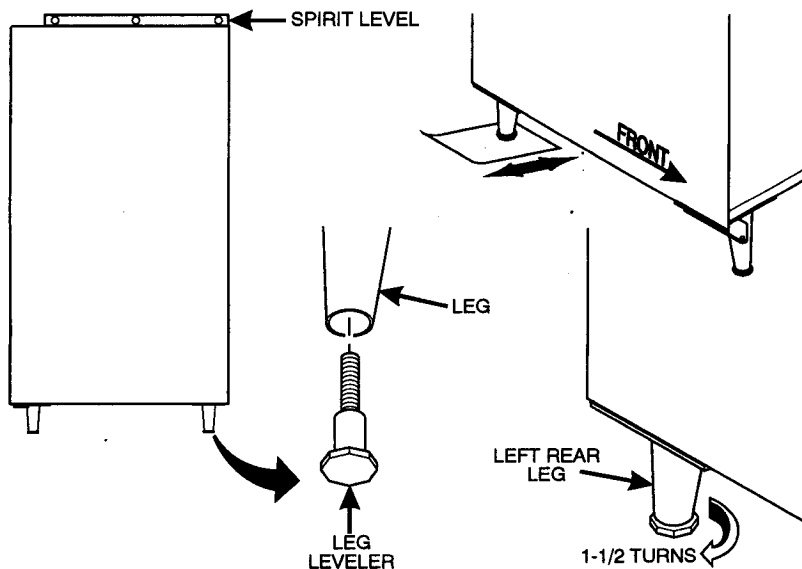



2. Mount the Base Plate:

WARNING

DO NOT MOVE THE CABINET WHILE HEX HEAD SCREWS AND/OR CARRIAGE BOLTS ARE LOOSENED. THE CABINET WOULD BECOME UNSTABLE AND LIKELY TO TIP AND CAUSE INJURY.

- a. Remove the pail(s) from the inside of the merchandiser.
- b. Remove the floor liner from the inside of the merchandiser.
- c. Remove the two caps as shown.
- d. Loosen the left leg assembly carriage bolts and nuts to allow mounting a base plate bracket.
- e. Secure one of the base plate brackets to the leg assembly using the two carriage bolt. Tighten the carriage bolts and nuts.
- f. Loosen the right leg assembly hex head screws to allow mounting the other base plate bracket.
- g. Secure the other base plate bracket to the right leg assembly using the two hex head screws. Tighten the hex head screws.
- h. Insert the short arms of the slides into the hinged tabs of the base plate. Position the slide so the notch near the short arm is on the bottom side.
- i. Insert the long arms of the slides into the base plate brackets.
- j. Insert and secure a cotter pin through the hole in the back of each of the slides.
- k. Push the base plate toward the merchandiser cabinet. The front tabs of the base plate brackets should seat in the notches in the long arms of the slides.
- l. Replace the caps, liner, and pail(s) removed previously.

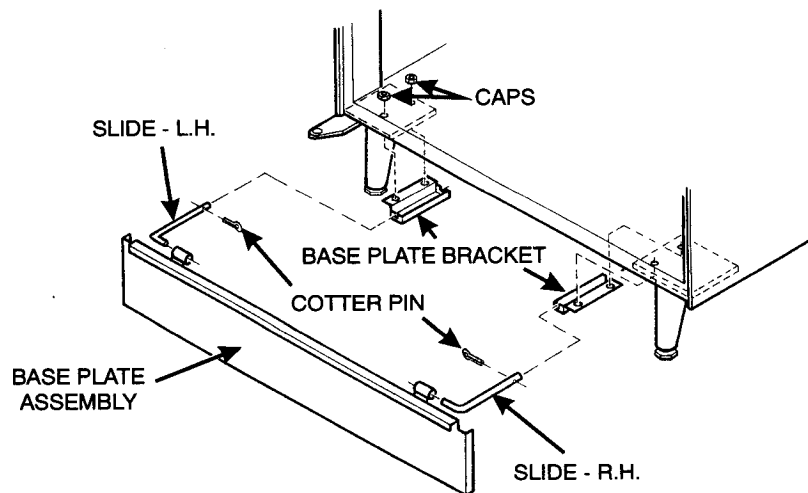



3. Install the Water Filter Cartridge:

IF YOUR MERCHANDISER HAS THE WATER FILTER OPTION, IT CANNOT BE OPERATED WITHOUT A PROPERLY INSTALLED WATER FILTER CARTRIDGE. If you do not have the water filter option, continue with "Fill the Tank".

CUNO BRAND ...

NOTE

Check the water filter installation record. There is a place to write the vend number on the cartridge. The cartridge is effective for a maximum of 64,000 7 oz. vends, 56,000 8 oz. vends, 50,000 9 oz. vends, or 37,000 12 oz. vends. Local conditions may require more frequent replacement.

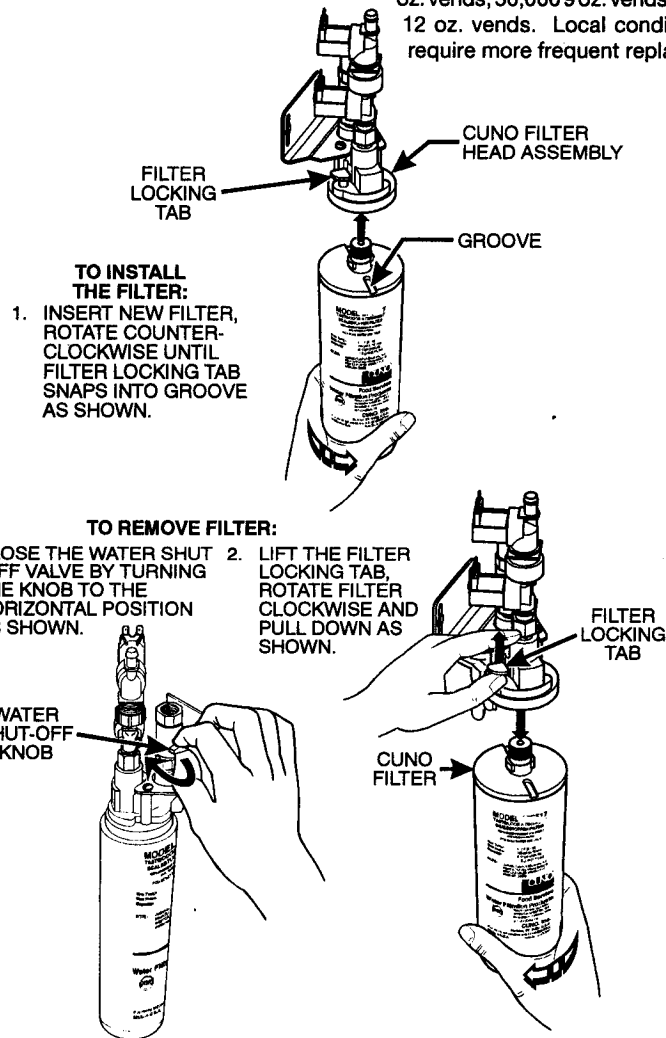



EVERPURE BRAND ...

NOTE

Check the water filter installation record. There is a place to write the vend number on the cartridge. The cartridge is effective for a maximum of 26,000 7 oz. vends, 22,000 8 oz. vends, 20,000 9 oz. vends, or 15,000 12 oz. vends. Local conditions may require more frequent replacement.

National Vendors recommends that you do the following procedure the **first time** you fill the tank in your merchandiser:

- a. Remove the small inner "O" ring from the filter cartridge.
- b. Install the filter cartridge.
- c. Turn on the water at its source, and perform the tank filling procedure.
- d. Turn off the water at its source, remove the filter cartridge, and replace the "O" ring.
- e. Install the filter cartridge.

TO INSTALL FILTER:

1. ALIGN RAISED RIB ON FILTER CARTRIDGE WITH MATING SLOT IN HEAD ASSEMBLY.
2. FIRMLY INSERT FILTER CARTRIDGE INTO HEAD ASSEMBLY AND ROTATE COUNTER-CLOCKWISE 1/4 TURN TO THE STOP.
3. OPEN THE WATER SHUT-OFF VALVE BY PUSHING THE HANDLE TO THE HORIZONTAL POSITION AS SHOWN BELOW.

TO REMOVE FILTER:

1. CLOSE THE WATER SHUT-OFF VALVE BY LIFTING THE HANDLE TO THE VERTICAL POSITION AS SHOWN BELOW.
2. ROTATE THE FILTER CLOCKWISE AND PULL DOWN AS SHOWN.

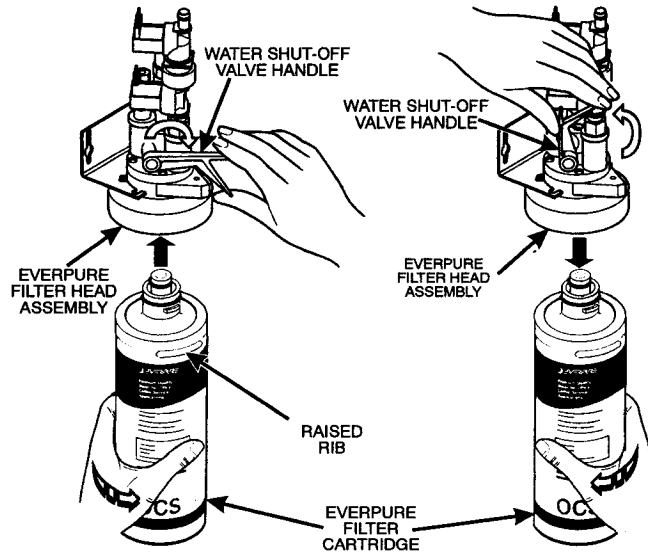



HYDROLIFE BRAND

INSTALLATION:

1. Place the filter inside the canister. Be sure the o-ring is seated in the canister just below the threads.
2. Screw the canister and filter assembly onto the filter head until it comes to a stop.
3. Open the water valve on the inlet line by rotating the handle to the vertical position as shown.

REMOVAL

1. Close the valve on the inlet line by rotating the handle into the horizontal position as shown.
2. Relieve water pressure by performing two or three water throws (see the programming section).
3. Unscrew the filter and canister assembly from the filter head. Remove the filter from the canister.

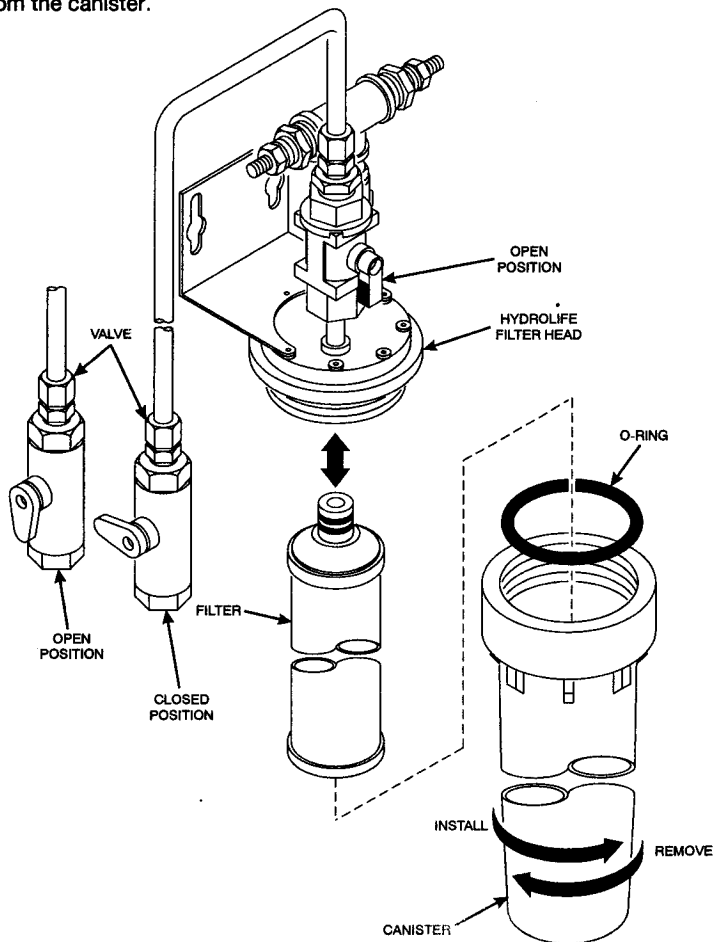



4. Load the Optional Filter Paper:

- Be sure the main power switch is in the *OFF* position.
- Remove the cup station and grounds bucket.
- Remove the paper holder cover by turning the fastener a quarter turn to the left.
- Insert a roll of paper into the paper holder. Route the free end of the paper to the brewer as shown.
- Replace the cover on the paper holder. Secure it by turning the fastener a quarter turn to the right.
- Feed paper over swing arm assembly and underneath pinion gear shaft.

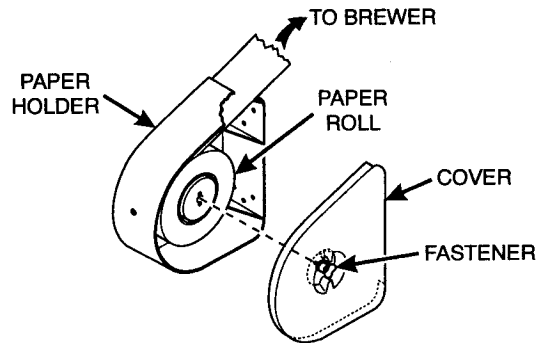

- Feed paper through the paper guides.
- Raise the basket housing assembly and feed paper over the lip of the paper mechanism housing.

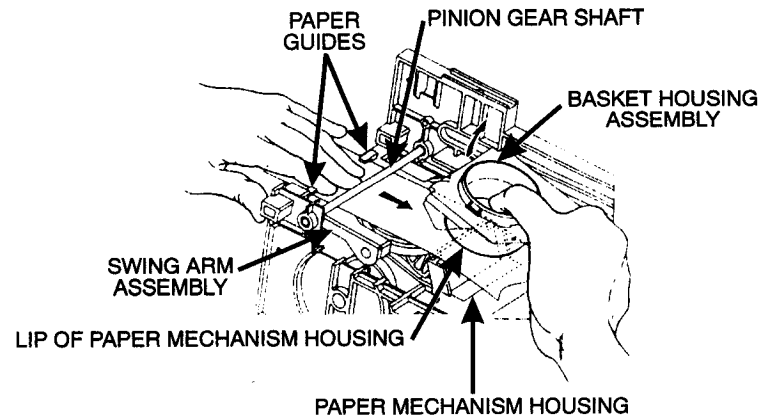

NOTE

It may be necessary to reach underneath the brewer between the paper mechanism housing and swing arm assembly to push paper over the lip of the paper mechanism housing.

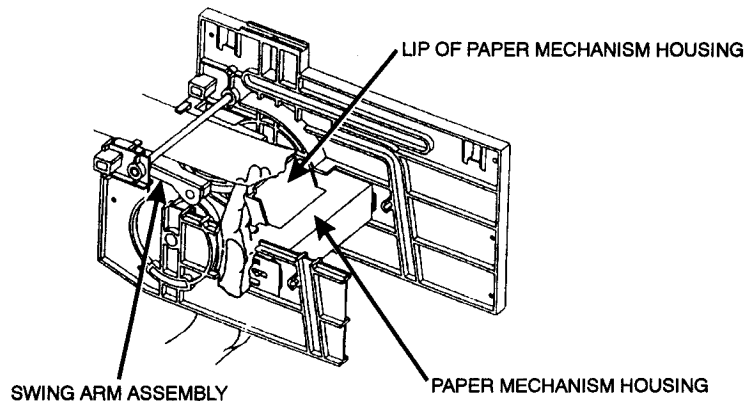

- i. Reach underneath the brewer between the paper mechanism housing and basket housing assembly and push paper into the top of the paper mechanism housing between paper rollers.

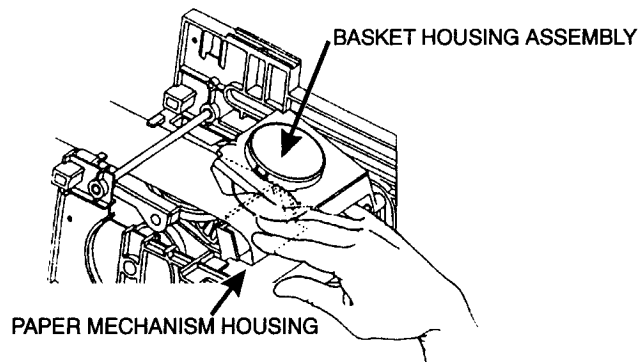

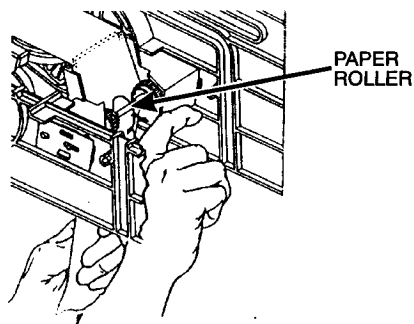

- j. Reach underneath the brewer and pull paper roller to the right.
- k. Pull paper down between the paper rollers.
- l. Release the paper roller.

CONTINUED . . .





- m. Place the main power switch in the *ON* position.
- n. Test the brewer to be sure the paper feeds properly:

1. On the maintenance keypad, press , then press  until the display shows **BREW TEST**.
2. Press  to test each brewer position:

WARNING

Keep away from the brewer mechanism while it is operating. Coming into contact with moving parts could injure you.

BREW'R BREW The brewer is in the BREW position.

BREW'R FLIP The brewer is in the FLIP position.

BREW'R HOME The brewer is in the HOME position.

3. Make sure the filter paper feeds properly without jamming.
- o. Replace the cup station and grounds bucket.

5. Install the Optional Coin Box Lock

- a. Install the lock cylinder, washer, and nut in the order shown.
- b. Tighten the nut.
- c. Install the lock bar as shown, and secure with the screw.

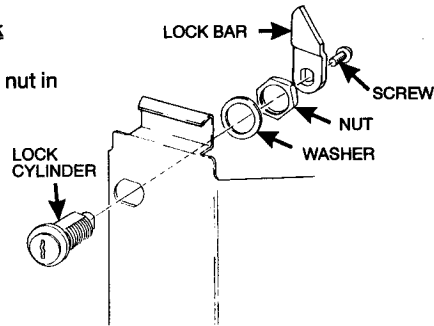

6. Set Up and Load the Coin Mechanism

Setting the Quarter Switch. If your coin mechanism is not a MARS TRC 6000, skip this procedure and begin **LOADING THE COIN MECHANISM**.

- a. Flip down the front of the coin mechanism as shown, and set the quarter switch.

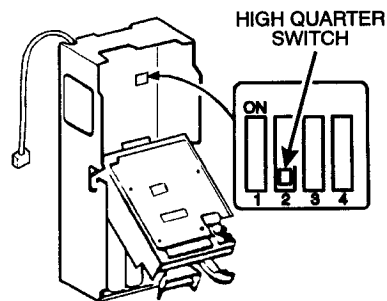



Load the Coin Mechanism.

- a. Open the cabinet door and the monetary door.
- b. Insert coins into their respective tubes until each tube has been filled.
- c. Inspect the tubes for shingled coins and correct if necessary.



7. Fill the Tank:

- a. Make sure the main power switch is ON.
- b. Turn on the water at its source.
- c. On the maintenance keypad, press  , then press  until the display shows **TANK.FILL**.
- d. Press  . You should hear water running into the tank, and the display will show **FILLING**. The water will run until either the tank is full or 12 minutes go by, whichever happens first.

NOTE

The inlet water valve only stays open for 12 minutes at a time. This is a safety feature to prevent water from running into a leaky system and making a mess. It is possible for your tank to take longer than 12 minutes to fill if your location has low water pressure. To be on the safe side, check for leaks if the water runs a long time. If you find none, everything is normal; you just have low water pressure.

- e. When you hear the water stop running, repeat steps 3 and 4. Under normal circumstances, nothing will happen. If water starts running and the display shows **FILLING** again, your pressure is low and it is just taking a long time to fill the tank. Repeat this step if necessary to be sure your water tank is full.

8. Fill the Canisters:

Open the lid as shown, and carefully pour the appropriate product into the canister. Repeat for all canisters in the machine.

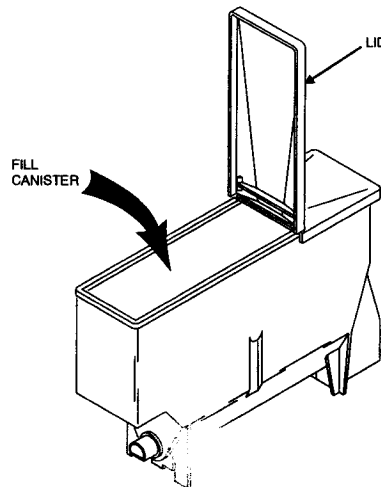



9. Load Cups:

CAUTION

Use only cups which have been designed for use in a hot beverage vending machine.

- a. Support the cup mechanism in the upright position.
- b. Push the latch forward to release the cup mechanism. Continue to support the cup mechanism while you lower it into the loading position.
- c. Remove the turret cover.

OBSERVE PROPER HYGIENE - DO NOT TOUCH THE CUPS!

- d. Open the bottom of the wrapper on a stack of cups.
- e. Insert the wrapped cups into the turret and pull the wrapper out.





DO NOT FILL CUPS ABOVE THE LEVEL MARKED ON THE OUTSIDE OF THE CUP TURRETS OR ABOVE THE "FILL LINE" LABEL INSIDE EACH TURRET, OR MOTOR JAMS WILL OCCUR.

USE ONLY THE SAME SIZE AND BRAND OF HOT DRINK CUPS IN EACH TURRET; DO NOT INTERMIX!

- f. Replace the turret cover after the turrets have been loaded.
- g. Be sure the cup mechanism is locked into the upright position.

10. Tell the Machine About the Cup Size(s):

Your Hot Drink Center can vend two different cup sizes, so you will need to "tell" the merchandiser the sizes of cups you have loaded into it.

- a. Press , then press  until the display shows **CUP X OZ.**
- b. Press  until the capacity of the regular size cups you loaded is displayed.
- c. Press , and the display shows **CUP.1 X OZ.**
- d. Press  until the capacity of the large size cups you loaded is displayed.

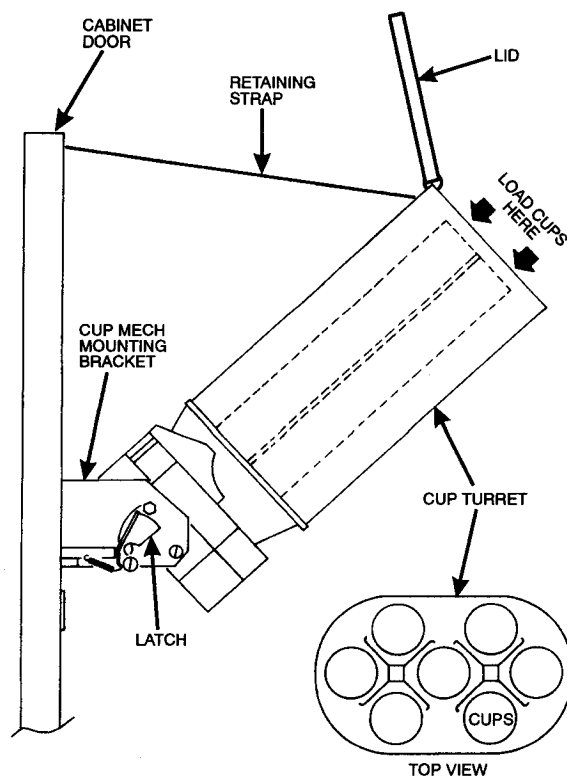
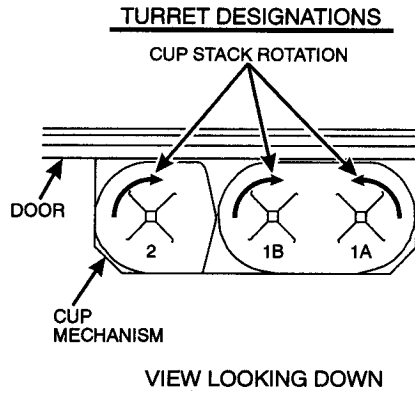



11. Test the Machine:

Your Hot Drink Center is now ready to vend coffee, just as soon as the water in the tank reaches its operating temperature. Press , and a reading of the tank temperature is displayed. When the display shows 94° C (202° F), it is ready for vending.

- a. Close the door, make a selection, and enjoy your cup of coffee!
- b. You will now need to do the following before your machine is ready to start earning money:
 - Set prices
 - Set up the menu
 - Establish time of day vending periods (if desired)
 - Customize the drink recipes (if desired)
 - Set up custom messages (if desired)

Refer to the **Programming** section for details on these and other procedures.



THIS PAGE INTENTIONALLY LEFT BLANK



ADJUSTMENTS AND MINOR MAINTENANCE

This section contains procedures not normally used during setup, but may come in handy later on.

WATER VALVE ADJUSTMENT

Water valves do not usually require adjustment, but in some cases adequate water volume cannot be achieved by the throw time setting alone (see the programming section). **IF ABSOLUTELY NECESSARY**, adjust the valves in conjunction with setting the factory default timers during the Product Configuration programming mode.

1. Using a slotted screwdriver, turn the adjustment screw clockwise to decrease the water flow rate.
2. Turn the adjustment screw counterclockwise to increase the water flow rate.

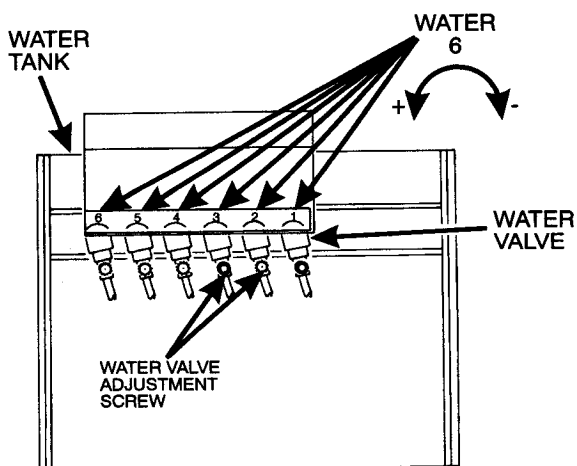



CUP MECHANISM ADJUSTMENT

1. Place seven cups in the cup ring.
2. Observe the clearance as shown in view B.
3. If necessary adjust by first loosening the adjustment arm screw (view A).
4. Move adjustment arm until correct clearance is achieved.
5. Hold adjustment arm in place and tighten adjustment arm screw.

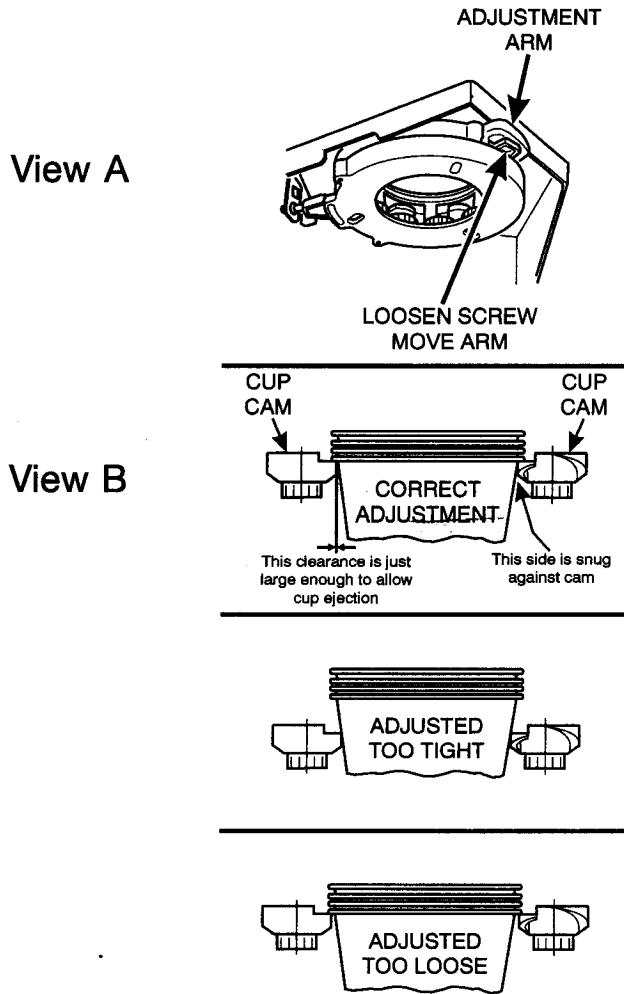



GRINDER ADJUSTMENT

A grind that is within the acceptable range will result in more controlled dispensing of grounds into the brew basket, and better extraction of coffee flavors. A grind that is too coarse results in poor extraction and spraying grounds in the brewer area. A grind that is too fine can overload the grinder motor as well as clog the screens in the brew basket and funnel.

The degree-of-grind scale attached to the grinder motor represents an acceptable range of grinds. Do not set the grinder beyond the limits of this scale.

1. Push the locking collar toward the canister and turn the grinder motor.
2. Turn clockwise for a finer grind and counterclockwise for a coarser grind. A notch on the locking collar indicates the grind on the scale.

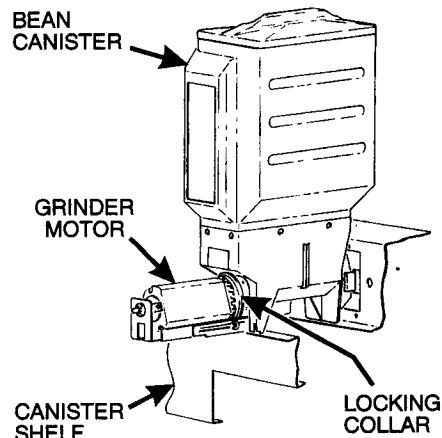

CAUTION

Do not turn the grinder motor too far in the clockwise direction. The grinder blades will come into contact and may be damaged.

3. Adjusting the grind may make it necessary to readjust the throw time. Use the factory default times as a starting point and proceed according to the directions in the "COLLECTING DRY PRODUCT GRAM THROWS" section.



DISENGAGING THE GRINDER

At certain times the bean grinder(s) need to be disengaged from the bean canister(s).

WARNING

Keep your fingers clear of all moving parts.

1. Using a screwdriver handle or other suitable tool, push up on the catch spring far enough to free the catch spring pin from the grinder shelf bracket assembly.
2. Pull the grinder and grinder bracket assembly towards you.
3. Pivot the grinder and grinder bracket assembly down.
4. Re-engage the grinder by pivoting it back up into position.

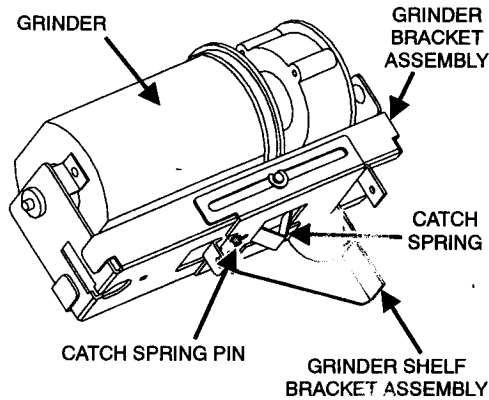

CANISTER INSTALLATION

1. Place the canister in position as shown.
2. Engage the pins on the motor shaft with the slots in the canister coupler.
3. Fit tabs on canister into the slots on the canister shelf.
4. To ensure canister is correctly engaged with the rear mounting bracket, gently push down on the front edge of the canister lid.

Canister Caps. The parts bag contains a number of red vinyl caps. Place these caps over the canister nozzle as shown to avoid spilling product when removing and replacing the canisters.

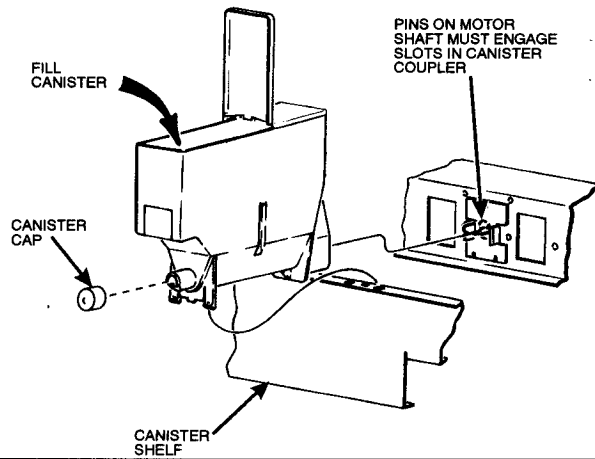



PROGRAMMING THE HOT DRINK CENTER

PROGRAMMING THE HOT DRINK CENTER

Getting Around

Getting around the Hot Drink Center software is pretty easy once you know the features that are available to you, and how to use them. The three main parts you will use are the SERVICE KEYPAD, the SELECTION SWITCH PANEL, and the DISPLAY.

The Service Keypad

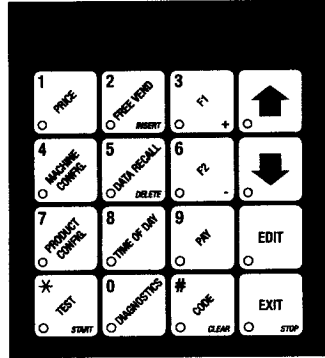

For most of your programming jobs, you will be using the service keypad, conveniently located on the monetary panel. The service keypad has 16 keys. The three columns on the left are the **MODE** keys. The right hand column contains the **MOVEMENT** keys.

The Selection Switch Panel

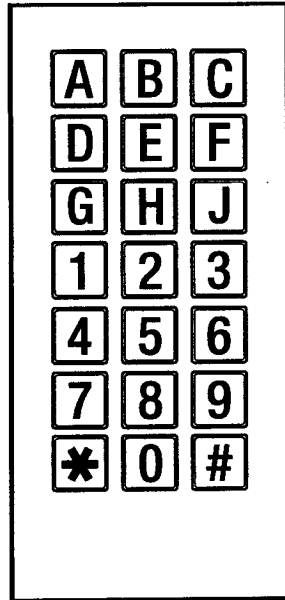

The selection switch panel is also located on the monetary panel. Unlike the service keypad, it is accessible when the cabinet door is closed. These are the keys the customer will use to make selections. You can also use these keys during programming procedures.



The diagram on the left is a picture of your path through a single task within the *PRODUCT CONFIGURATION* programming mode. Think of the diagram as if it were a house, with each display representing a room in the house. The *EDIT* key is a one-way front door, and the *EXIT* key is just that - a one-way exit. The arrow keys are doorways between the rooms, and you can go either way between them.

Look at the example. From the *PRODUCT* display, you can press the down arrow key and set up the sugar throw. If you wanted to set up dry products, press the *EDIT* key. The first screen you see will let you adjust the throw time for the selection A dry product. Pressing the down arrow key takes you to the extra strong selection A dry product. Pressing the down arrow again takes you to the selection B product; pressing the up arrow key returns you to the previous display, and so forth. When you get to the last dry selection (in this case, it's I), pressing the down arrow moves you back to the top of the list. At any point, you can press the *EXIT* key and return to the *PRODUCT* display. Pressing the down arrow there takes you to the *SUGAR* display. From either *PRODUCT* or *SUGAR*, pressing *EXIT* gets you back to the standby message.

SHORTCUT:

When setting up selections, you can go directly to the selection you are interested in simply by pressing the appropriate letter key. Let's say you wanted to set up the throw time for the D selection dry product. Instead of repeatedly pressing the down arrow, you can press *D*, and you will immediately get the display for that selection.

The Displays

The 10-character display performs two functions, and is referred to in this book as "the display":

1. It shows the customer's selection and how much credit is in the machine, as well as the ready, service, and time of day messages.
2. It provides information and feedback to the service person during maintenance.





The Function Keys

The FUNCTION keys on the service keypad can be used for up to three things:

THE NUMBER

YOU MIGHT BE ASKED TO ENTER A NUMERICAL VALUE. YOU CAN DO THIS IN TWO WAYS: PRESSING THIS KEY IS THE SAME AS PRESSING THE "5" ON THE SELECTION SWITCH PANEL.



THE PRIMARY PURPOSE

THIS IS THE MAIN JOB OF THE KEY. FROM THE STANDBY MESSAGE, IT WILL ALLOW YOU TO ENTER A PROGRAMMING MODE. IN THIS EXAMPLE, YOU CAN VIEW STORED SALES DATA.

THE SECONDARY PURPOSE

THIS IS THE KEY'S "SECOND JOB". THIS KEY CAN BE USED TO DELETE A CHARACTER WHEN YOU ARE EDITING CUSTOM MESSAGES.

Other Keys

The MOVEMENT keys on the control panel let you move inside a mode, and back and forth between modes. To see how these keys let you move around, study the flow diagram on the next page.



The up and down arrow keys are your "legs", which let you move up and down the list of tasks. These keys are what let you continue from one step to the next in programming procedures.



This is your "activate" or "choose" key. It "opens a door" to additional information and lets you begin a programming task once you are inside of a mode. Sometimes, it is used as a toggle switch to show you your choices during a programming task.



This is your "end" key. Pressing it one or more times will move you back to the start of the mode, or all the way back to the standby message.



This key lets you start an action, such as a test.



Control Panel Switch Functions Explained

Each of the control panel switches has one or more jobs to do. This list will give you a short overview of those jobs.



Press this button to put your machine into the Price Setting mode. You can see maximum and minimum machine prices, and change prices for entire machine or individual selection.



Press this button to set up how the Free Vend mode will operate.



Press this button to view the water tank temperature, software version number, machine and accessory configuration, and active selection status.

Press this button to:



- Select display language
- Select coin mechanism and options
- Select bill validator and options
- Select card reader and options
- Select monetary options
- Set winner feature
- Set mug discount option



Press this button to:

- View total sales and vends by whole machine, selection, or drink
- Clear resettable data
- View or set machine ID size



Press this button to:

- Download data into your portable data collection device (PDCD), OR
- Set printer baud rate, depending upon which device you are using

Press this button to:



- Set machine configuration
- Set up drinks
- Set which selections are active
- Set temperature display units (°F or °C)
- Set cup size and options
- Select sanitation and rinse times
- Set tank temperature
- Set delivery door options
- Set whipper options

Press this button to:



- Set time of day
- Set day, month, year
- Set up time of day intervals for inhibit, freevend, and discount vending
- Select display messages
- Edit messages
- Set message scrolling speed



Press this button to pay one or more coins from the coin mechanism.



- Allows you to see any fault or condition that has placed the machine out of service



Press this button to:

- Perform TEST VENDS
- Test machine functions
- Test displays
- Fill the water tank



Press this button to:

- Enter the SUPERVISOR mode
- Change the SUPERVISOR access code
- Lock and unlock access to functions
- Set free vend code



PROGRAMMING FLOWCHARTS

Programming Flowcharts

The flowcharts on the following pages will provide you with a "map" to the different programming features of your machine. Once you are familiar with the detailed programming steps given later in this section, you can use the flowcharts as a shortcut. Each chart begins with the key you will use to access those steps. Follow the lines and arrows from one step to another. A rectangular box contains the functions or tasks you will perform at that point. A diamond shaped box is a decision statement. For example, look at the MACHINE CONFIGURATION chart, below. At one point, you are asked to choose between an EXEC coin mechanism and all others. Depending upon your decision, you will take a different path. Note that choosing any mechanism except an EXEC gives you several more steps to perform before you get to the WINNER option.

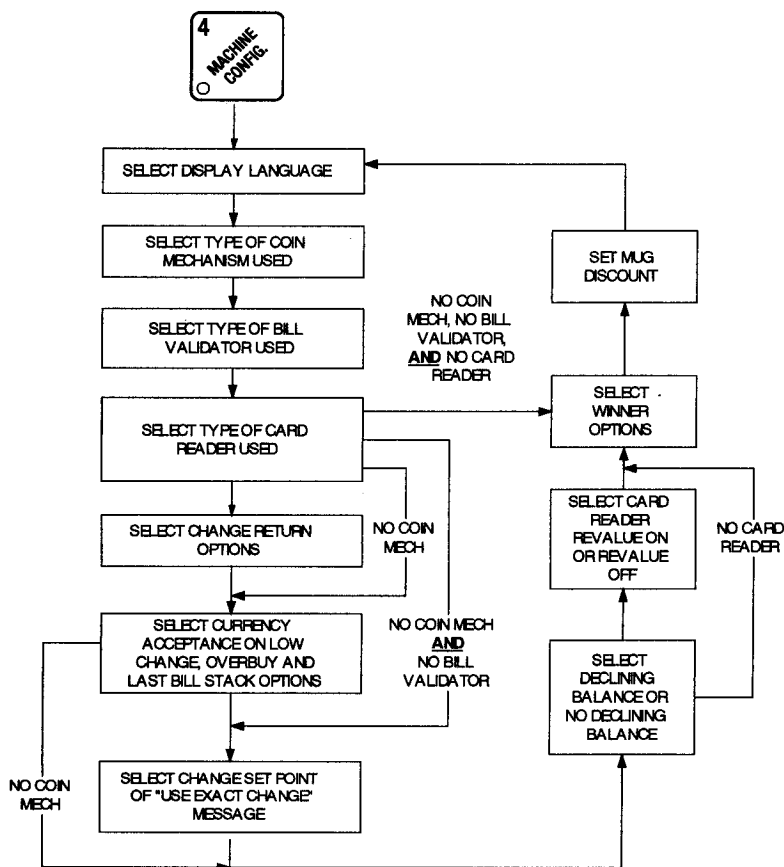

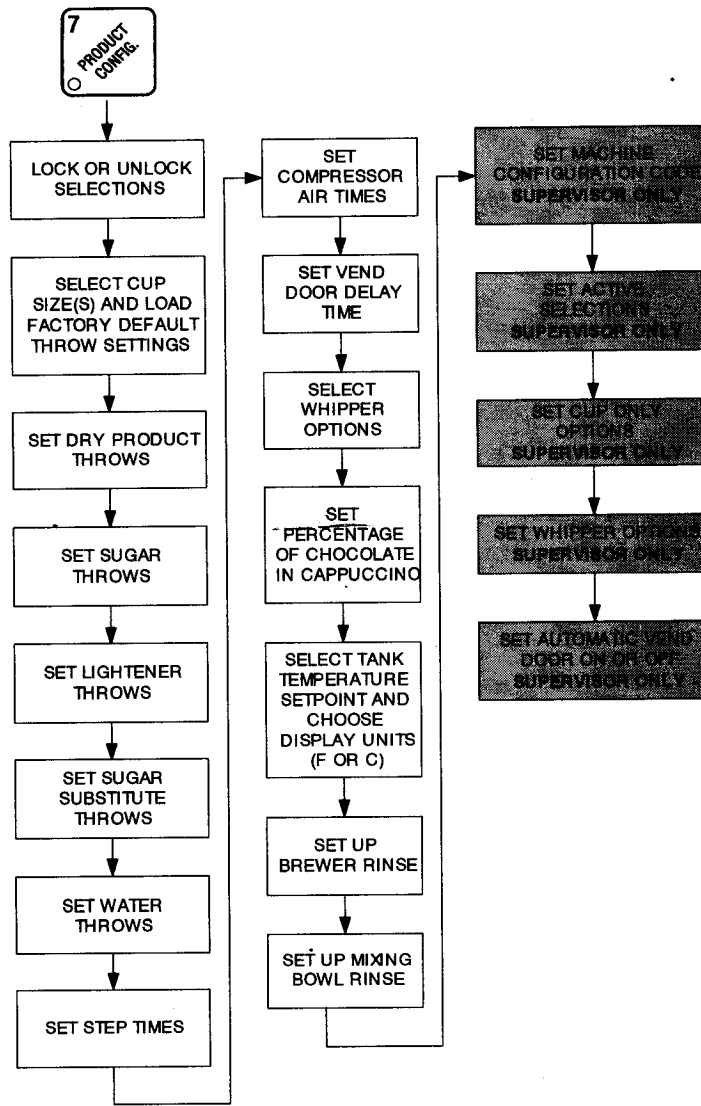

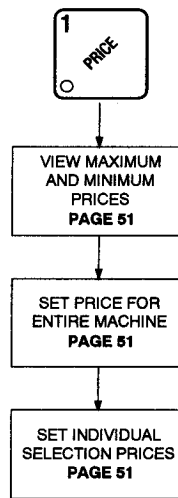

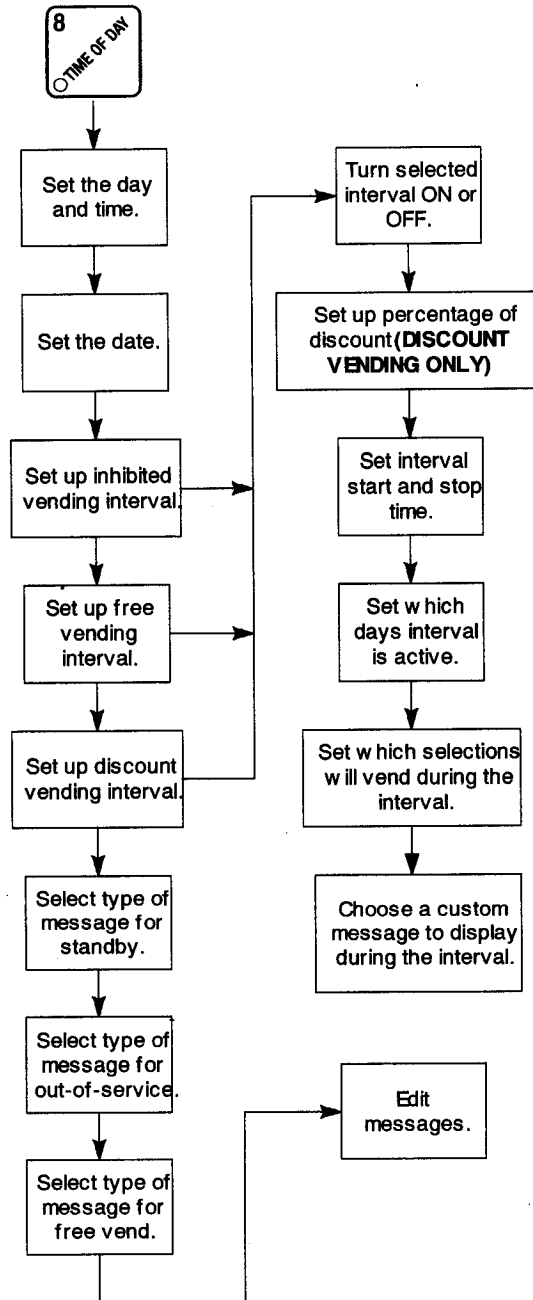

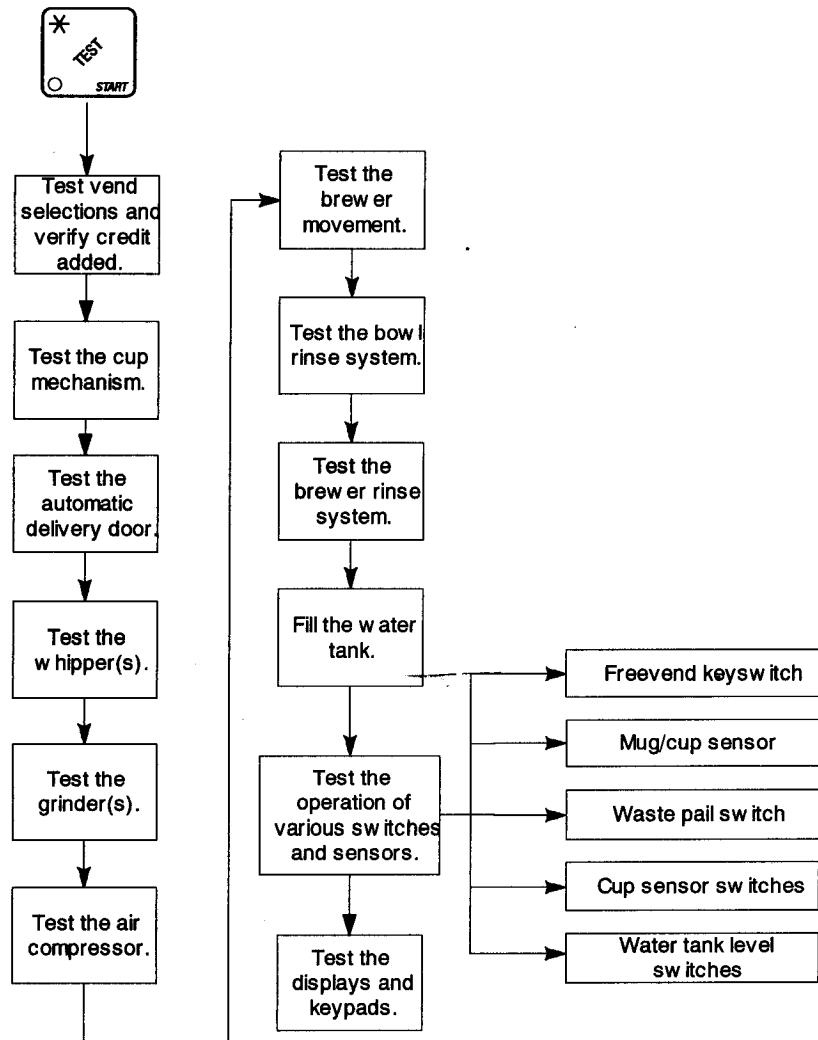

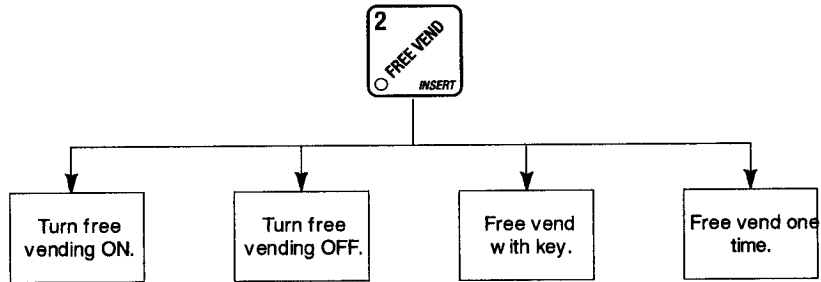
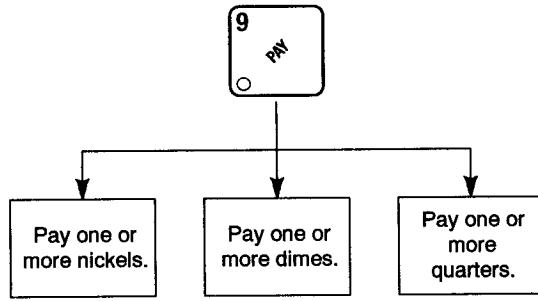

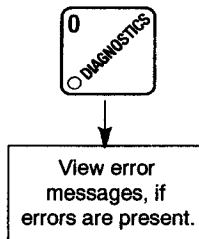
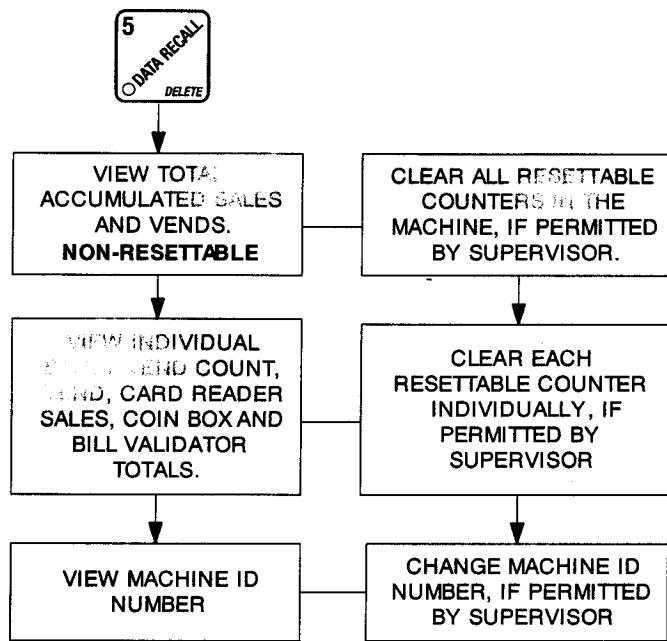

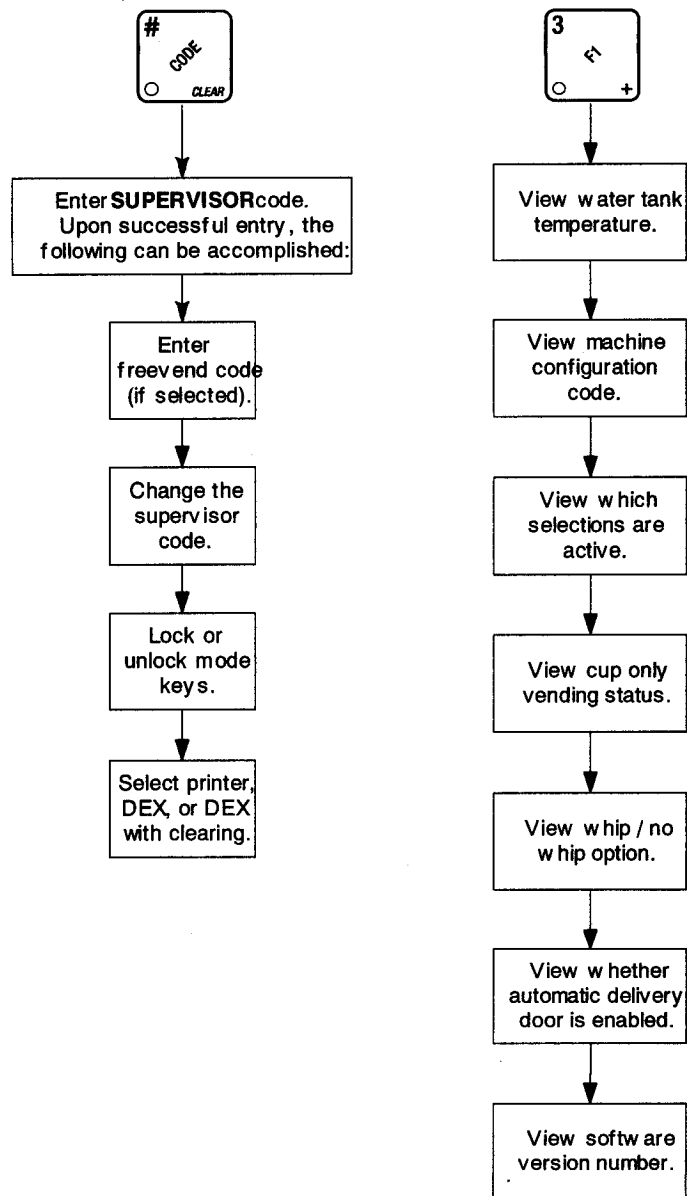





Programming Procedures

SOME CONVENTIONS:

The pages that follow contain all the programming procedures for the Hot Drink Center. If you need to do a specific task, you can find it immediately by using the Programming Index. Most of the procedures have things in common, and here is a short guide to help you through these conventional presentations:

All programming procedures assume that you are starting with the standby message showing in the display. If not, just press  until you get there.

Each programming procedure is highlighted by a pointing hand:  so it will stand out.

To exit a mode (CONTINUE) at any time, press . Sometimes you may have to press the key more than once in order to exit all the way to the standby message.

Text that looks like this: *DISPLAY* represents what you will see in the display on the monetary panel.

Definitions and helpful information will appear in shadow boxes:

HELPFUL HINT

THE SUPERVISOR MODE

The supervisor is allowed to do things that a normal user cannot, like controlling access to certain modes. The supervisor can lock out any of the programming modes to anyone who does not have the right "key". Once a supervisor enters the proper code, he or she will be able to:

- Change the supervisor access code
- Lock out any or all of the service keypad modes
- Set whether data is cleared with  or after being downloaded into a portable data collection device
- Grant or deny access to data items during **DATA RECALL**
- Modify the machine configuration



GAIN ACCESS TO THE SUPERVISOR MODE

1. Press . The display shows: *ENTER CODE*. You must enter the four-digit supervisor code within 6 seconds to gain access.



NOTE

A new machine has a factory-set supervisor code of **0000**.

When you have entered the right code, you will hear two beeps and see **UNLOCKED** in the display.



ENTER A NEW SUPERVISOR CODE

1. Follow the steps in **GAIN ACCESS TO THE SUPERVISOR MODE**.
2. Press , then  until the display shows *SUPER XXXX*. The X's represent the current supervisor code. Use the number keys to enter a new code.

IMPORTANT!

If you enter a new code, be sure to keep a written record of it. There is no other way to access the SUPERVISOR mode.

3. CONTINUE.



ENTER A FREEVEND CODE

1. Follow the steps in **GAIN ACCESS TO THE SUPERVISOR MODE**.
2. Press  until the display shows *FREE XXXX*. The X's represent the current freevend code. Use the number keys to enter a new code. If the code is anything other than "0000", it must be entered after the key lock is turned in order to enable free vends.
3. CONTINUE



LOCK OR UNLOCK MODE OR PAYOUT KEYS

1. Follow the steps in **GAIN ACCESS TO THE SUPERVISOR MODE**.

2. Press  until the display shows either *X. LOCKED* or *X. UNLOCKED*.

"X" refers to the number or character shown on the mode or payout key in question (1 through 9, # and *). To see if a key is locked or unlocked, press that key.

3. Press  to change between locked and unlocked. When anyone other than the supervisor tries to enter a locked mode, the display shows *LOCKED*.

NOTE

The following mode keys cannot be locked out:



4. CONTINUE.



SET PRINTER OR DEX OPTIONS

1. Follow the steps in **GAIN ACCESS TO THE SUPERVISOR MODE**.

2. Press  until the display shows:

PRINTER means that data will be sent directly to a printer,

OR

DEX ONLY means that data remains in memory after it is downloaded into a portable data collection device (PDCD),

OR



DEX +CLR means that resettable data is cleared after it is downloaded into a PDCD.

3. Press  to change between the three choices.

4. CONTINUE.



LOCK OR UNLOCK DATA CLEARING ACCESS

1. Follow the steps in **GAIN ACCESS TO THE SUPERVISOR MODE**.
2. Press  until the display shows either **#. LOCKED** or **#. UNLOCKED**. **LOCKED** means that non-supervisors cannot clear resettable machine sales and vend data from the  key.
3. Press  to switch between **#. LOCKED** and **#. UNLOCKED**.



NOTE

The supervisor can clear data regardless of this setting, provided the supervisor code was correctly entered first.

4. CONTINUE





SELECT DISPLAY LANGUAGE

1. Press . The current LANGUAGE is shown in the display. Press  to choose the desired language. Your choices are: **ENGLISH, DEUTSCH, FRANCAIS, ESPANOL, PORTUGUES, SWEDISH, or NEDERLANDS**.
2. CONTINUE



SELECT COIN MECHANISM AND OPTIONS

1. Press , then press  until the current COIN MECHANISM is shown in the display. Press  to choose the desired coin mechanism.

Your choices are: *DUMB MECH*, *ADB MECH*, *EXEC MECH*, or *NO MECH*

NOTE

If you selected *EXEC MECH* you can exit the function.

2. Press  until the display shows *CHANGE X.XX*.

Coins and bills which are less than or equal to this value will be returned without a purchase being made.

Examples:

- CHANGE 0.00* - Forced vend; NO change returned without a purchase.
- CHANGE .25* - Nickels, dimes, and quarters returned without purchase.
- CHANGE 1.00* - \$1 bills and SBAs will be returned as change without purchase. Nickels, dimes, and quarters are also returned.

3. Press  until the display shows: *LOW.MSG X.XX*. The display will

show *USE EXACT CHANGE* when the amount of available change in the coin mechanism falls below the value of "X.XX". Enter a value with the number keys. For example, if *LOW.MSG 1.00* is displayed, the *USE EXACT CHANGE* message is displayed when less than a dollar's worth of change is in the coin mechanism.

4. CONTINUE.



SELECT BILL VALIDATOR AND OPTIONS

1. Press , then press  until one of the following is displayed:

- NO DBV* - No bills will be accepted or there is no bill validator installed (you can exit the function).
- SER.1.2.5.10.20* - The serial bill validator is selected and will accept \$1, \$2, \$5, \$10, and \$20 bills. Use BILL SELECTION METHOD below to change the bills which will be accepted.



MDB.1.2.5.10.20 - A standard MDB bill validator is selected. It will accept \$1, \$2, \$5, \$10 and \$20 bills. Use BILL SELECTION METHOD below to change the bills which will be accepted.

BILL SELECTION METHOD:

The standard \$1, \$2, \$5, \$10 and \$20 bills are enabled by pressing the 1, 2, 5, 6, or 7 key(s), respectively, to display which bill(s) will be accepted.



MDB. <★> - An MDB bill validator which accepts non-standard bills or tokens is connected and operating. Press





to enter list of bills. (See **INITIAL SETUP OF**

NON-STANDARD BILL VALIDATOR on the following page.)

BILL LIST OPERATION:

Use  and  to scroll through the list of bills.

Use  to turn the bill acceptance ON or OFF.

Use  to move up to the top level screen

1. 1.00 ON - 1. = Bill validator channel 1, each bill has its own channel
1.00 = Bill value
ON = \$1.00 bill will be accepted

1. 1.00 OFF - OFF = \$1.00 bill will not be accepted

TKN - Token bills (same as coupon bills)



INITIAL SETUP OF NON-STANDARD BILL VALIDATOR:

Connect the bill validator, select MDB in the bill validator selection screens. The standard "MDB.1.2.5.10.20" screen will appear first. Exit the

bill validator setup by pressing . Bill information is now collected from the validator. Re-enter the bill validator selection screen and the non-standard screen "MDB. <*>" will appear.

PULSE DBV - The pulse bill validator will accept \$1 bills.

Press  to choose the desired option.

2. CONTINUE.



SELECT MONETARY OPTIONS

This function lets you set declining balance, currency acceptance on low change, overbuy, and last bill stacking options.

This function lets you:

- Set declining balance,
- Set currency acceptance on low change,
- Set overbuy options,
- Set last bill stacking options

DECLINING BALANCE: Once credit is established, multiple vends may occur until the coin return is pressed.

1. Press , then press  until one of the following is displayed:

DECLINE.ON - More than one vend is allowed, with a declining balance.

OR

DECLINE.OFF - A declining balance is not allowed.

Press  to display the desired choice.



2. Press  until one of the following is displayed:

ACC <\$\$ X.XX - The last bill which meets or exceeds maximum price will be held in escrow.

OR

ACC.STK X.XX - The last bill which meets or exceeds maximum price and MDB coupon bills (token bills) will be immediately stacked.

Example: If setting is ***ACC.STK 1.00*** and maximum price is \$1.50. This setting will immediately stack the second \$1.00 bill inserted.

Press  to display the desired choice.

The value of "X.XX" has two purposes:

- a. The value of "X.XX" tells the machine how big a bill or coin to accept even though there is not enough change in the coin mech to cover all possible paybacks.
 - For example, enter **1.00**. Therefore, the machine will take a dollar bill or coin even though there is less than \$1.00's worth of change. Entering **5.00** tells the machine to take a five even though there is less than \$5.00's worth of change, and so forth.
- NOTE:** This could cause a customer to be short-changed.
- Entering **0.00** means that bills or coins will only be accepted if there is enough change to cover them.
- b. The value of "X.XX" tells the machine how much the customer is allowed to overbuy a product. The customer will be short-changed when an overbuy occurs.

Example:

For a value of \$0.25: if there is no change in the machine and the customer inserts a \$1.00 bill. The customer can purchase a product for \$0.75 even though the change cannot be paid back. The customer will be short-changed. Normally a purchase will not be approved unless all change can be paid.

Entering 0.00 means that the vend will only be approved when the correct change can be returned (overbuy disabled).

3. CONTINUE



SELECT CARD READER AND OPTIONS

1. Press , then press  until the current card reader is shown in

the display. Press  to choose the desired card reader.

Your choices are: *NO CARD, DUMB CARD, or MDB CARD.*

2. Press  until one of the following is displayed:

REVALUE.ON - Allows credit to be transferred onto the card

REVALUE.OFF - Credit cannot be transferred to the card

CAUTION

Do not select REVALUE.ON if the card reader manufacturer does not allow the card to be revalued at the vending machine.

Press  to display the desired choice.

3. CONTINUE



SET UP WINNER MODE

WINNER: At pre-selected intervals, a customer may receive a refund for a selection. You can select the intervals and qualifying selections.

- 1. Press  , then press  until one of the following is displayed:

WINNER OFF Winner function is disabled.

OR

WIN XXX Winners are allowed at certain intervals, represented by "XXX".



Press  to display the desired choice.

If you selected **WINNER OFF**, you can CONTINUE. Otherwise, go to the next step.

- 2. The display shows **WIN XXX**. XXX represents the number of vends which must occur per each winner vend. For example, an interval number of 50 means that a winner can happen any one time during the next 50 vends. Using the number keys, enter an interval number between 10 and 9999.

- 3. Press  . The display shows * .----- . The dashes in the display represent which selections are allowed winners. Press the appropriate letter key to enable a selection; pres the key again to disable it. For example, pressing **A**, **C**, and **E** will cause the display to look like this: * **A-C-E**----- , meaning that all sizes of A, C, and E selections can have a winner.

ADVANCED OPTIONS:

- Press  to enable all selections; press  to disable all selections.
- Press **0** or **1** to enable winners by cup size.



AN EXAMPLE . . .

You want to enable winners on all selections except E and F. Do the following:

- a. Press  . The letters **A** through **J** appear in the display instead of the dashes.
- b. Press **E** and **F**. The letters **E** and **F** in the display are replaced by dashes.
- 4. CONTINUE.





SET UP THE MUG DISCOUNT

- Press , then press  until the display shows **MUG DSC XX.XX**. The **XX.XX** represents the value of the discount customers will receive for using mugs or cups. Enter the amount with the number pad. Enter **0** for no discount.
- CONTINUE.



SET THE PRINTER BAUD RATE

- Press . The display will show one of the following rates:
BAUD 1200, BAUD 2400, BAUD 4800, or BAUD 9600.
- Press  until the desired baud rate is displayed. **NOTE:** This baud rate must match that of your printer, or it won't work properly.
- CONTINUE.



LOCK OR UNLOCK SELECTIONS

Selections can be **LOCKED OUT** (made unavailable for vending). You may want to do this if there is a problem with that selection, such as no product in the canister.

- Press . The display shows **LK.-----**. This shows a list of selections which are locked. Here, all selections are unlocked because they show up as dashes (-). Press the appropriate selection letter to switch from locked to unlocked and back again. For example, to lock out the "A" and "C" selections, press those letter keys on the selection switch panel. For this example, the display will show **LK.A-C-----**.

You can lock all selections at once by pressing



Unlock them all at once by pressing



- CONTINUE.



SET CUP SIZES

Your Hot Drink Center is capable of vending drinks in two different size cups. Be sure that the cups sizes you select in this step correspond with the cup sizes you actually load in the machine.

- 1. Press . The display shows **CUP1 X OZ.**

Refer to the TURRET DESIGNATIONS figure to see where these cups normally go. This display indicates that the cups in turrets 1A and 1B (normally regular cups) are X ounces.

- 2. Press until the desired cup size is displayed.

- 3. Press . The display shows **CUP2 Y OZ.**

Refer again to the TURRET DESIGNATIONS figure to see where these cups normally go. The cups in turret 2 (normally large cups) are Y ounces.

- 4. Press until the desired cup size is displayed.



TO LOAD THE FACTORY DEFAULT TIME SETTINGS . . .

for your cup size, press . **CLEARING** is displayed; keep holding the key until you see **FINISHED** in the display.

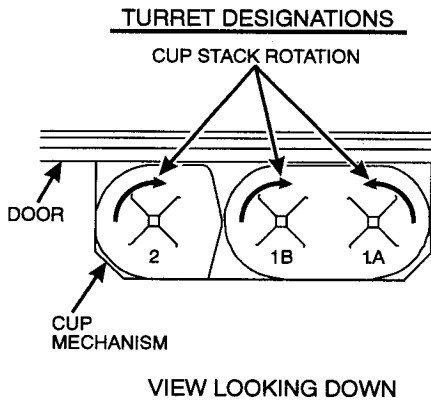

- 5. CONTINUE.





**SET THE DRY PRODUCT THROW TIMES**

1. Press , then press  until the display shows *PRODUCT*.
2. Press . The display shows *DRY. A .XX*. "XX" represents the throw time of the product for selection A. See "**SETTING THROWS**" for instructions on how to change the time for this and all other selections.
3. CONTINUE.

**SET THE SUGAR THROW TIMES**



1. Press , then press  until the display shows *SUGAR*.
2. Press . The display shows *SUG. A .XX*. "XX" represents the sugar throw time for selection A. See "**SETTING THROWS**" for instructions on how to change the time for this and all other selections.
3. CONTINUE.

**SET THE LIGHTENER THROW TIMES**

1. Press , then press  until the display shows *LIGHTENER*.
2. Press . The display shows *LIT. A .XX*. "XX" represents the lightener throw time for selection A. See "**SETTING THROWS**" for instructions on how to change the time for this and all other selections.
3. CONTINUE.





SET THE SUGAR SUBSTITUTE THROW TIMES (IF PRESENT)

1. Press , then press  until the display shows *SUGAR SUB*.
2. Press . The display shows *SUB. A .XX*. "XX" represents the sugar substitute throw time for selection A. See "**SETTING THROWS**" for instructions on how to change the time for this and all other selections.
3. CONTINUE.





SET THE WATER THROW TIMES

1. Press , then press  until the display shows *WATER*.
2. Press . The display shows *WAT. A .XX*. "XX" represents the water throw time for selection A. See "**SETTING THROWS**" for instructions on how to change the time for this and all other selections.
3. CONTINUE.





SET THE STEEP TIMES

1. Press , then press  until the display shows *STEEP*.
2. Press . The display shows *STP. A .XX*. "XX" represents the steep time for selection A. See "**SETTING THROWS**" for instructions on how to change the time for this and all other selections.
3. CONTINUE.







SET THE AIR COMPRESSOR RUNNING TIMES

1. Press , then press  until the display shows *AIR*.
2. Press . The display shows *AIR. A .XX*. "XX" represents the air compressor running time for selection A. See "**SETTING THROWS**" for instructions on how to change the time for this and all other selections.
3. CONTINUE.







SET END-OF-VEND DELAY TIME

This setting can delay the end of the vend (*THANK YOU* message and delivery door opening) to compensate for increased liquid flow times inside the machine.

1. Press , then press  until the display shows *DELAY*.
2. Press . The display shows *DLY.A X*. "X" is the delay time (in seconds) for the **A** selection.
3. Enter a new value, if desired, between 1 and 99.
4. Repeatedly pressing  will display the delay times for all selections. At each display, change the delay time if desired.
5. CONTINUE.





SET WHIPPER OPTIONS

1. Press , then press  until the display shows *WHIPPERS*.
2. Press . The display shows *WHP.A XXX*. "XXX" represents the whipper options for selection A as listed below.
3. Press  to change:
 - ON- The last 3 seconds of the drink is always whipped
 - ON+ The whole drink is always whipped
 - OFF The drink is never whipped
 - If J WHIP is selected (see VIEW MACHINE OPTIONS):**
 - OPT- The last 3 seconds of the drink is whipped only when the J key is pressed
 - OPT+ The whole drink is whipped only when the J key is pressed
 - If J NO WHIP is selected (see VIEW MACHINE OPTIONS):**
 - OPT- The last 3 seconds of the drink is whipped unless the J key is pressed
 - OPT+ The whole drink is whipped unless the J key is pressed.
4. Repeatedly pressing  will display the whipper options for all selections. At each display, change the option if desired.
5. CONTINUE.



ADJUST THE WATER TANK TEMPERATURE SETPOINT

1. Press , then press  until the display shows *SET XXX °F*. XXX represents the water tank temperature setpoint in degrees Fahrenheit. If a decimal point appears next to the "F", the heater is on.
2. If desired, enter a new setpoint. Accepted range: 149° - 205° F (65° - 96° C). The lower limit for vending is 10° below setpoint, up to a maximum of 180° F (82° C).
3. To change units (replace the "F" with a "C" for Celsius), press .
4. CONTINUE.



SET THE RATIO OF CHOCOLATE IN CAPPUCCINO

1. Press , then press  until the display shows either:

RATIO XX "XX" is the percentage of chocolate contained in a cappuccino drink.

OR

RATIO OFF No ratio is selected.

2. Press  to switch between these two displays. To change the value of

RATIO XX, enter the numbers directly. This is a quick way to set up your cappuccino drinks. See table D2 to see the actual throw times/amounts for certain preset ratios. You can set a ratio close to your taste, turn ratio OFF, then alter the product throw.

NOTE

Leaving this step with **RATIO OFF** displayed does not alter any previous settings for **E** and **I** selections. Leaving this step with a ratio set will alter those settings. The ratio automatically selects the times for water and dry product throw. The **E** and **I** selections no longer appear in the displays for those steps. If you desire greater control over your cappuccino drinks, leave ratio OFF.

3. CONTINUE.



SET THE BREWER RINSE TIME INTERVAL

1. Press , then press  until the display shows **SAN.TIM X.X**.

"X.X" represents the time of day (in hours and tenths of hours) the machine rinses the brewer. For example, **SAN.TIM 4.5** means that brewer rinse takes place at 4:30 am. Use the number keys to enter a new time, if desired. Range: 0.0 - 23.9 in .1 hour (6 minutes) increments.

2. Press . The display shows **SAN.HRS X.X**. "X.X" represents how soon the machine rinses the brewer after the last brewed selection. For example, **SAN.HRS 2.5** means brewer rinse takes place 2.5 hours after the last vend. Use the number keys to enter a new time, if desired. Range: 2.0 - 12.5 hours, in .1 hour (6 minutes) increments.

3. CONTINUE.



SET THE MIXING BOWL RINSE TIME AND INTERVAL

1. Press , then press  until the display shows one of the follow-

ing:

RIN.TIM X.X "X.X" represents the time of day (in hours and tenths of hours) the machine rinses the bowls. For example, **RIN.TIM 4.5** means that the bowl rinse takes place at 4:30 am. Range: 0.0 - 23.9 in .1 hour (six minute) increments.

OR

RINSE OFF No bowl rinse takes place.

OR

RIN.HRS X.X "X.X" represents how soon (in hours and half hours) the machine rinses the bowls after a vend. For example, **RIN.HRS 2.5** means that the bowl rinse takes place 2 and a half hours after the last vend. Range: 2.0 - 12.5 in .1 hour (six minute) increments.



2. Press  to switch between these options, and the number keys to enter new values.
3. CONTINUE.

NOTE

If 24 hours passes without a vend, no rinsing will take place. This eliminates unnecessary rinsing over a weekend or holiday.



SET THE MACHINE CONFIGURATION CODE (Supervisor Mode Only)

1. Press , then press  until the display shows **CONFIGURE**.
2. Press . The display shows **CONF WXYZ** "WXYZ" is the machine con-

figuration code. W represents the machine type, X is the soup and sugar substitute configuration, Y is the brewer configuration, and Z is canister mapping. The following tables give the possible values for each of the four numbers. Enter the appropriate configuration code for your machine.

3. CONTINUE.

Machine Type Configuration

| Enter for (W) | Definition |
|---------------|-----------------------------|
| 1 | Hot Drink Center |
| 2 | Reserved for alternate use. |

6th Product (Selection C) Configuration

| Enter for (X) | Definition |
|---------------|---|
| 1 | No 6th product |
| 2 | 6th product present, but receives no condiments |
| 3 | 6th product present, may receive condiments |
| 4 | Water only |

| | |
|-----------------------|---|
| SINGLE BREW | A machine with only one brewed selection (the second selection is freeze dried). Uses a single barrel brewer. |
| DUAL BREW | A machine with two brewed selections. Uses either a dual or single barrel brewer. |
| DUAL CONDIMENT | A machine with two separate sets of condiments (lightener/sugar) to avoid cross-flavoring. Normally used with a dual barrel brewer. |



Brewer Configuration

| Enter for (Y) | Coffee Mix | Number of Brewers | Condiment Sets |
|---------------|-------------|-------------------|----------------|
| 1 | Single Brew | One | Single |
| 2 | Dual Brew | One | Single |
| 3 | Dual Brew | Two | Single |
| 4 | Single Brew | One | Dual |
| 5 | Dual Brew | Two | Dual |
| 6 | Freeze Dry | None | Single |
| 7 | Freeze Dry | None | Dual |

Canister Mapping (See Figure Below)



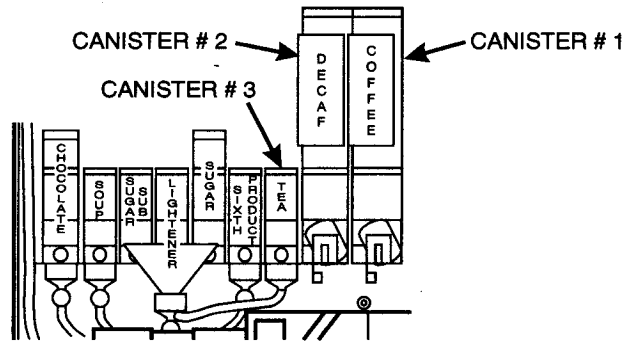

| Enter for (Z) | Menu Selection Letters for Canister Numbers | | |
|---------------|---|---|---|
| | 3 (Single condiment only) | 2 | 1 |
| 1 | F | B | A |
| 2 | F | A | B |
| 3 | B | F | A |
| 4 | B | A | F |
| 5 | A | F | B |
| 6 | A | B | F |

Index: A = Coffee B= Decaf F = Tea



CANISTER MAPPING

**SET UP ACTIVE SELECTIONS (Supervisor mode only)**

1. Press , then press  until the display shows **0. ABCDEFGH**.
These are the selections that are active for drink 0, the regular size cup. In this display, all selections are active. Press the appropriate letter to turn selection availability ON or OFF.
2. Press  until the display shows **1. ABCDEFGH**. These are the selections that are active for drink 1, the large size cup. In this display, all selections are active. Press the appropriate letter to turn selection availability ON or OFF.
 - Press  to turn on all selections,
 - Press  to turn off all selections.



NOTES

Any selection not shown will not appear in any other configuration step, and will return a **MAKE ANOTHER SELECTION** message if selected by a customer. Press the appropriate letter to turn selection availability ON or OFF.

Selections not available because of machine configuration will not be shown in this list.

3. CONTINUE.

**SET UP THE CUP ONLY OPTION (Supervisor mode only)**

1. Press , then press  until the display shows **CUPVND X/Y**.
This allows you to set whether a customer can buy a cup only (no drink), and which types of cups will be vended.
"X/Y" represents the cup only vend configuration.
2. Press  to switch between the following configurations:
 - /- = Cup only not allowed
 - 0/- = Regular cup only vended
 - /1 = Large cup only vended
 - 0/1 = Both cup sizes vended

3. CONTINUE.



SET UP WHIP OPTIONS (Supervisor mode only)

1. Press , then press  until the display shows either:

J WHIP This means that optionally whipped selections will be whipped when **J** is pressed.

OR

J NO WHIP Optionally whipped selections will be whipped *unless J* is pressed.

2. Press  to switch between these two displays.
3. CONTINUE.



SET UP DELIVERY DOOR OPTIONS (Supervisor mode only)

1. Press , then press  until the display shows either:

DOOR ON The automatic delivery door (if so equipped) is enabled.

OR

DOOR OFF The automatic delivery door (if so equipped) is disabled.

2. Press  to switch between these two choices.

NOTE

DOOR OFF must be selected if your machine does not have an automatic delivery door.

3. CONTINUE.



SETTING THROWS

Except for where indicated, the procedures for setting dry product, sugar, lightener, sugar substitute, and water throws are identical. This example will take you through setting the throw for a dry product. The illustration shows a typical display with all possible elements present:

THE "1" MEANS THAT THIS SELECTION IS IN THE ALTERNATE SIZE CUP (CUP1) FROM STEP 2 OF THE PRODUCT CONFIGURATION PROCEDURE. REMEMBER WHAT YOU SELECTED IN STEP 2 OF PRODUCT CONFIGURATION. IF BOTH CUP SIZES ARE THE SAME, THIS "1" WILL NEVER APPEAR.

THE PLUS SIGN SHOWS THAT THIS IS FOR A STRONG DRINK.

DRY.1B+ 1.75

THIS INDICATES WHICH ITEM IS BEING EDITED. THE CHOICES ARE: DRY, SUG, LIT, SUB, OR WAT.

THIS IS THE SELECTION LETTER.

THIS IS THE ACTUAL THROW TIME, SHOWN IN SECONDS AND 100THS OF A SECOND.

1. **DRY.A X.XX** Enter a new throw time (represented by XXX) for the dry selection **A** product.
2. Subsequent displays will contain the various elements as shown above, depending upon your machine configuration.

SOME DIFFERENCES . . .

- Sugar, lightener, and sugar substitute will be used for both **A** and **B** (coffee) selections. Therefore, the **A** and **B** will not appear in the displays. The coffee selections are represented by *.
- Subsequent displays will show selection letters for all the remaining selections containing those items.
- All timers except DELAY timers are entered in .05 second increments. DELAY timers are entered in whole second increments.



COLLECTING DRY PRODUCT GRAM THROWS

Measuring the gram throw allows you to get the right amount of dry product or condiment into your hot drink. To do this, you need a container to catch the product throw and an accurate gram scale to measure its weight.

1. Make a measuring container by cutting down a paper cup until it fits under the canister spout as shown.
2. Weigh the measuring cup and zero the gram scale accordingly.
3. Make 5 test throws as instructed in the programming steps, then average the results.
4. Weigh the test throw.
5. Repeat steps 3 and 4 until you get the correct product or condiment weight.

Tables D1 and D2 show the factory default settings for the various dry products sold by the merchandiser. They are good starting points for you to use in setting up your machine. In the end, the amount of dry product or condiments you use in your drinks depends upon taste and manufacturers' recommendations. Recommended weights and times are for guidance only, and you do not have to adhere to them.

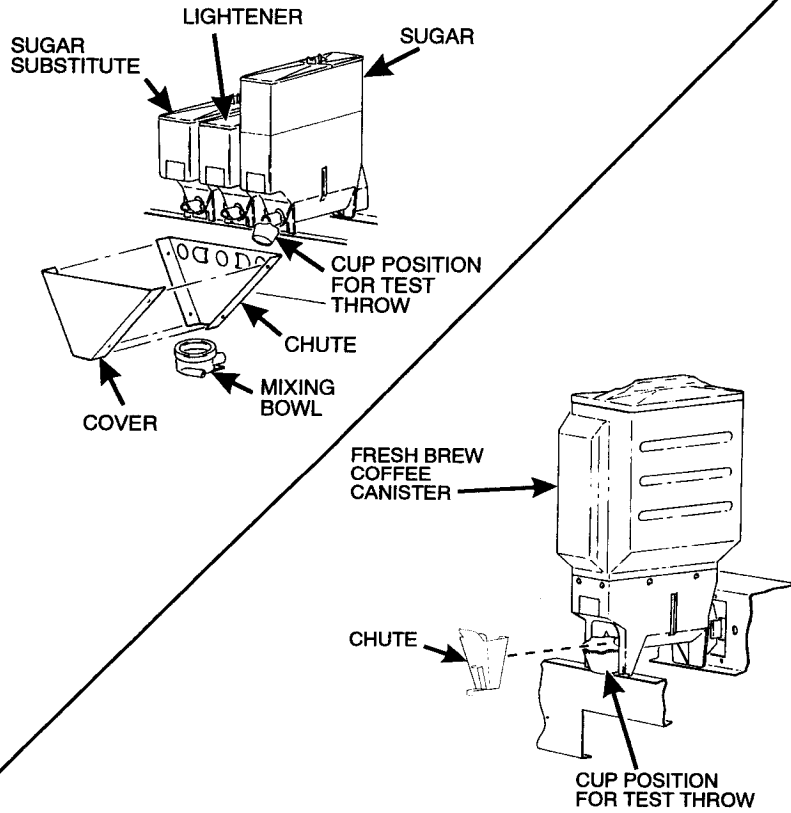

COLLECTING DRY PRODUCT GRAM THROWS

DRY PRODUCT WEIGHT AND THROW TIME FACTORY DEFAULT SETTINGS

Table D1. Dry Product Weight and Throw Time Factory Default Settings

| Selection | | Weight (in grams) per size cup | | | | | |
|-----------|-------------------------------------|---------------------------------------|---------------|---------------|---------------|---------------|---------------|
| | | Throw times (in seconds) per size cup | | | | | |
| | | 5 oz | 7 oz | 8 oz | 9 oz | 10 oz | 12 oz |
| A | Fresh brew coffee | 5.70 1.60 | 8.00 2.20 | 9.00 2.50 | 10.00 2.80 | 11.00 3.10 | 13.00 3.65 |
| A | Freeze dry coffee | 0.90 0.20 | 1.20 0.30 | 1.50 0.40 | 1.60 0.50 | 1.80 0.55 | 2.20 0.70 |
| A | Strong freeze dry coffee | 1.10 0.25 | 1.50 0.40 | 1.80 0.55 | 2.00 0.65 | 2.20 0.70 | 2.60 0.90 |
| B | Fresh brew decaf | 5.70 1.6 | 8.00 2.20 | 9.00 2.50 | 10.00 2.80 | 11.00 3.10 | 13.00 3.65 |
| B | Freeze dry decaf | 0.90 0.15 | 1.20 0.25 | 1.50 0.35 | 1.60 0.40 | 1.80 0.45 | 2.20 0.60 |
| B | Strong freeze dry decaf | 1.10 0.20 | 1.50 0.35 | 1.80 0.45 | 2.00 0.50 | 2.20 0.60 | 2.60 0.75 |
| C | Soluble Product | 10.8 2.80 | 15.0 3.90 | 17.8 4.60 | 19.4 5.00 | 21.6 5.60 | 25.9 6.70 |
| D | Fresh brew coffee ESPRESSO | 5.70 1.60 | 8.00 2.20 | 9.00 2.50 | 10.00 2.80 | 11.00 3.10 | 13.00 3.65 |
| D | Freeze dry coffee ESPRESSO | 0.90 0.20 | 1.20 0.30 | 1.50 0.40 | 1.60 0.50 | 1.80 0.55 | 2.20 0.70 |
| D | Strong freeze dry coffee ESPRESSO | 1.05 0.25 | 1.50 0.40 | 1.80 0.55 | 2.00 0.65 | 2.20 0.70 | 2.60 0.90 |
| E | Fresh brew coffee CAPPUCCINO | 5.70 1.60 | 8.00 2.20 | 9.00 2.50 | 10.00 2.80 | 11.00 3.10 | 13.00 3.65 |
| E | Freeze dry coffee CAPPUCCINO | 0.90 0.20 | 1.20 0.30 | 1.50 0.40 | 1.60 0.50 | 1.80 0.55 | 2.20 0.70 |
| E | Strong freeze dry coffee CAPPUCCINO | 1.05 0.25 | 1.50 0.40 | 1.80 0.55 | 2.00 0.65 | 2.20 0.70 | 2.60 0.90 |
| F | Instant tea | 0.90 0.70 | 1.20 1.00 | 1.50 1.25 | 1.60 1.30 | 1.80 1.60 | 2.20 1.85 |
| F | Strong instant tea | 1.10 0.90 | 1.50 1.25 | 1.80 1.60 | 2.00 1.75 | 2.20 1.85 | 2.60 2.10 |
| G | Chocolate | 17.00 3.25 | 24.00 4.60 | 28.00 5.40 | 31.00 5.90 | 34.00 6.50 | 41.00 7.80 |
| H | Soup | 4.30 0.80 | 6.00 1.15 | 7.00 1.30 | 7.60 1.40 | 8.50 1.60 | 10.20 1.90 |
| H | Soluble Product | 10.8 2.80 | 15.0 3.90 | 17.8 4.60 | 19.4 5.00 | 21.6 5.60 | 25.9 6.70 |



Table D1. Dry Product Weight and Throw Time Factory Default Settings (Continued)

| Selection | Weight (in grams) per size cup* | | | | | |
|--------------------------------------|---------------------------------------|--------------|--------------|---------------|---------------|---------------|
| | Throw times (in seconds) per size cup | | | | | |
| | 5 oz | 7 oz | 8 oz | 9 oz | 10 oz | 12 oz |
| I Chocolate used in cappuccino | 3.10 0.45 | 4.50 0.65 | 5.00 0.80 | 5.80 0.85 | 6.20 0.95 | 7.60 1.15 |
| D Sugar used in espresso | 2.10 0.20 | 3.00 0.25 | 3.50 0.30 | 4.00 0.35 | 4.50 0.40 | 5.50 0.50 |
| D Extra sugar used in espresso | 3.00 0.25 | 4.00 0.35 | 4.50 0.40 | 5.00 0.45 | 5.50 0.50 | 6.50 0.60 |
| E Sugar used in cappuccino | 3.50 0.30 | 5.10 0.40 | 6.00 0.50 | 6.80 0.55 | 7.70 0.65 | 9.40 0.85 |
| E Extra sugar used in cappuccino | 4.60 0.35 | 6.80 0.55 | 7.70 0.65 | 8.50 0.75 | 9.40 0.85 | 11.00 1.00 |
| F Sugar used in tea | 4.20 0.40 | 6.00 0.50 | 7.00 0.60 | 8.00 0.70 | 9.00 0.80 | 11.00 1.00 |
| F Extra sugar used in tea | 5.50 0.50 | 8.00 0.70 | 9.00 0.80 | 10.00 0.90 | 11.00 1.00 | 13.00 1.20 |
| F Lightener used in tea | 1.20 0.70 | 1.50 0.85 | 2.00 1.15 | 2.50 1.45 | 3.00 1.70 | 4.00 2.25 |
| F Extra lightener used in tea | 1.50 0.85 | 2.00 1.15 | 2.50 1.45 | 3.00 1.70 | 3.50 2.00 | 4.50 2.60 |
| F Sugar substitute used in tea | 0.60 0.30 | 0.85 0.40 | 1.00 0.50 | 1.10 0.55 | 1.30 0.65 | 1.50 0.75 |
| F Extra sugar substitute used in tea | 0.80 0.40 | 1.10 0.55 | 1.30 0.65 | 1.40 0.70 | 1.60 0.80 | 1.90 0.95 |
| ** Sugar | 4.20 0.40 | 6.00 0.50 | 7.00 0.60 | 8.00 0.70 | 9.00 0.80 | 11.00 1.00 |
| ** Extra sugar | 5.50 0.50 | 8.00 0.70 | 9.00 0.80 | 10.00 0.90 | 11.00 1.00 | 13.00 1.20 |
| ** Lightener | 1.20 0.70 | 1.50 0.85 | 2.00 1.15 | 2.50 1.45 | 3.00 1.70 | 4.00 2.25 |
| ** Extra lightener | 1.50 0.85 | 2.00 1.15 | 2.50 1.45 | 3.00 1.70 | 3.50 2.00 | 4.50 2.60 |
| ** Sugar substitute | 0.60 0.30 | 0.85 0.40 | 1.00 0.50 | 1.10 0.55 | 1.30 0.65 | 1.50 0.75 |
| ** Extra sugar substitute | 0.80 0.40 | 1.10 0.55 | 1.30 0.65 | 1.40 0.70 | 1.60 0.80 | 1.90 0.95 |

D = Espresso
E = Cappuccino

I = Chocolate times for cappuccino

* The actual gram weight of a product or condiment throw will vary depending upon the type of product or condiment used. The weights given are approximate based upon factory testing.

** Separate sugar, lightener, and sugar substitute timers are available for selections A/B/C, D, E, and F.



CAPPUCCINO

Cappuccino is made with various ratios of chocolate to coffee, according to taste. Lightener (E timer) is also used for cappuccino. Table D2 shows numerous different ways to make cappuccino for each size of cup in your machine. For example, the default chocolate-to-coffee ratio of 15 - 85 in a 7 oz. cup consists of the following:

- A chocolate throw (product I) lasting 0.65 seconds, providing 15% of the normal chocolate throw (approximately 4.5 grams*).
 - A water throw for the chocolate (water I) lasting 2.65 seconds (chocolate product throw plus 2 seconds to ensure the mixing bowl is fully rinsed). The volume is about 56 ml, depending upon how the flow rate is adjusted.
 - A throw for cappuccino coffee (product E) equal to a normal coffee (product A) throw.
- OR
- A water throw for the freeze dry coffee selection (water E) lasting for 5.50 seconds (101 ml).
 - A water throw for the fresh brew coffee selection (water E) lasting for 2.00 seconds (115 ml). **In either case the water volume is enough to fill the remainder of the cup.**

The actual mixing sequence is as follows:

1. The coffee portion of cappuccino is made using the same canister/valve combination as the normal (A) coffee.
2. After the coffee is completely in the cup, the chocolate portion is made with the selection G canister/valve combination. This gives the drink its traditional "layering".

* Chocolate weights will vary with different products.

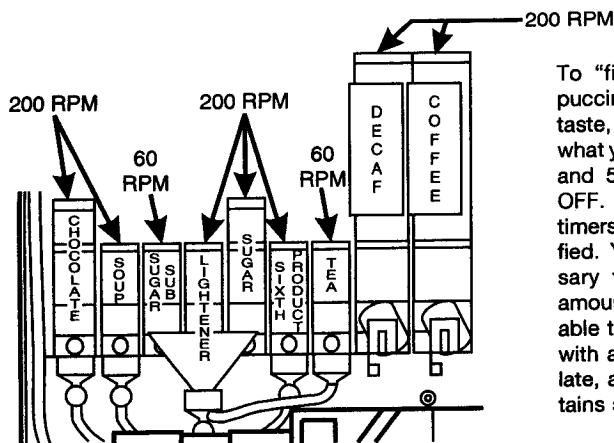

MOTOR SPEED BY LOCATION

HINTS:

To "fine tune" your Cappuccino drink to your exact taste, set a ratio close to what you like (between 15% and 50%), then turn ratio OFF. Adjust the individual timers until you are satisfied. You may find it necessary to cut down on the amount of sweetener available to a cappuccino drink with a high ratio of chocolate, as the chocolate contains sweetener of its own.



Table D2. Dry Product Settings for Cappuccino (5 oz. cup)

| CHOCOLATE | | | | FREEZE DRY COFFEE | | | | FRESH BREW COFFEE | | | |
|--------------|-------------|--------------|----------------|-------------------|--------------|----------------|--------------|-------------------|----------------|--------------|--|
| Percent | Weight (gm) | Timing (sec) | Water Settings | | Percent | Water Settings | | Percent | Water Settings | | |
| | | | Volume (ml) | Timing (sec) | | Volume (ml) | Timing (sec) | | Volume (ml) | Timing (sec) | |
| 15 (default) | 3.10 | 0.45 | 52 | 2.45 | 85 (default) | 57 | 3.40 | 85 (default) | 58 | 2.70 | |
| 20 | 4.10 | 0.65 | 54 | 2.65 | 80 | 54 | 3.20 | 80 | 55 | 2.50 | |
| 25 | 5.00 | 0.80 | 56 | 2.80 | 75 | 52 | 3.05 | 75 | 53 | 2.40 | |
| 30 | 5.80 | 0.95 | 59 | 2.95 | 70 | 49 | 2.95 | 70 | 49 | 2.30 | |
| 35 | 6.70 | 1.10 | 61 | 3.10 | 65 | 47 | 2.75 | 65 | 47 | 2.20 | |
| 40 | 7.60 | 1.30 | 63 | 3.30 | 60 | 44 | 2.55 | 60 | 45 | 1.95 | |
| 45 | 8.40 | 1.45 | 66 | 3.45 | 55 | 41 | 2.40 | 55 | 41 | 1.85 | |
| 50 | 9.30 | 1.60 | 68 | 3.60 | 50 | 38 | 2.25 | 50 | 38 | 1.75 | |

Table D2. Dry Product Settings for Cappuccino (7 oz. cup)

| CHOCOLATE | | | | FREEZE DRY COFFEE | | | | FRESH BREW COFFEE | | | |
|--------------|-------------|--------------|----------------|-------------------|--------------|----------------|--------------|-------------------|----------------|--------------|--|
| Percent | Weight (gm) | Timing (sec) | Water Settings | | Percent | Water Settings | | Percent | Water Settings | | |
| | | | Volume (ml) | Timing (sec) | | Volume (ml) | Timing (sec) | | Volume (ml) | Timing (sec) | |
| 15 (default) | 4.50 | 0.65 | 56 | 2.65 | 85 (default) | 101 | 5.50 | 85 (default) | 115 | 4.35 | |
| 20 | 5.80 | 0.90 | 59 | 2.90 | 80 | 97 | 5.25 | 80 | 110 | 4.15 | |
| 25 | 7.10 | 1.15 | 63 | 3.15 | 75 | 92 | 5.00 | 75 | 104 | 3.90 | |
| 30 | 8.00 | 1.35 | 65 | 3.35 | 70 | 90 | 4.80 | 70 | 102 | 3.80 | |
| 35 | 9.30 | 1.60 | 69 | 3.60 | 65 | 86 | 4.55 | 65 | 96 | 3.60 | |
| 40 | 10.50 | 1.80 | 72 | 3.80 | 60 | 81 | 4.35 | 60 | 92 | 3.50 | |
| 45 | 11.80 | 2.05 | 76 | 4.05 | 55 | 77 | 4.10 | 55 | 87 | 3.25 | |
| 50 | 13.10 | 2.30 | 79 | 4.30 | 50 | 72 | 3.85 | 50 | 83 | 3.05 | |



Table D2. Dry Product Settings for Cappuccino (8 oz. cup)

| CHOCOLATE | | | | FREEZE DRY COFFEE | | | | FRESH BREW COFFEE | | | |
|--------------|-------------|--------------|----------------|-------------------|--------------|----------------|--------------|-------------------|----------------|--------------|--|
| Percent | Weight (gm) | Timing (sec) | Water Settings | | Percent | Water Settings | | Percent | Water Settings | | |
| | | | Volume (ml) | Timing (sec) | | Volume (ml) | Timing (sec) | | Volume (ml) | Timing (sec) | |
| 15 (default) | 5.40 | 0.80 | 59 | 2.90 | 85 (default) | 132 | 6.80 | 85 (default) | 153 | 5.20 | |
| 20 | 6.80 | 1.05 | 62 | 3.05 | 80 | 128 | 6.55 | 80 | 150 | 5.10 | |
| 25 | 8.00 | 1.35 | 66 | 3.35 | 75 | 122 | 6.25 | 75 | 144 | 4.90 | |
| 30 | 9.30 | 1.60 | 69 | 3.60 | 70 | 117 | 6.00 | 70 | 137 | 4.70 | |
| 35 | 11.00 | 1.85 | 73 | 3.85 | 65 | 112 | 5.75 | 65 | 131 | 4.45 | |
| 40 | 12.70 | 2.15 | 78 | 4.15 | 60 | 108 | 5.45 | 60 | 124 | 4.25 | |
| 45 | 14.00 | 2.40 | 82 | 4.40 | 55 | 105 | 5.20 | 55 | 118 | 4.00 | |
| 50 | 15.65 | 2.70 | 85 | 4.70 | 50 | 91 | 4.90 | 50 | 112 | 3.80 | |

Table D2. Dry Product Settings for Cappuccino (9 oz. cup)

| CHOCOLATE | | | | FREEZE DRY COFFEE | | | | FRESH BREW COFFEE | | | |
|--------------|-------------|--------------|----------------|-------------------|--------------|----------------|--------------|-------------------|----------------|--------------|--|
| Percent | Weight (gm) | Timing (sec) | Water Settings | | Percent | Water Settings | | Percent | Water Settings | | |
| | | | Volume (ml) | Timing (sec) | | Volume (ml) | Timing (sec) | | Volume (ml) | Timing (sec) | |
| 15 (default) | 5.8 | 0.85 | 60 | 2.85 | 85 (default) | 140 | 7.30 | 85 (default) | 172 | 5.85 | |
| 20 | 7.6 | 1.15 | 64 | 3.15 | 80 | 134 | 7.00 | 80 | 155 | 5.65 | |
| 25 | 8.8 | 1.45 | 68 | 3.45 | 75 | 130 | 6.70 | 75 | 152 | 5.45 | |
| 30 | 10.5 | 1.75 | 72 | 3.75 | 70 | 125 | 6.40 | 70 | 144 | 5.10 | |
| 35 | 12.3 | 2.05 | 77 | 4.05 | 65 | 119 | 6.10 | 65 | 138 | 4.90 | |
| 40 | 13.9 | 2.35 | 82 | 4.35 | 60 | 113 | 5.80 | 60 | 133 | 4.70 | |
| 45 | 15.3 | 2.65 | 85 | 4.65 | 55 | 109 | 5.50 | 55 | 126 | 4.45 | |
| 50 | 17.1 | 2.95 | 90 | 4.95 | 50 | 105 | 5.20 | 50 | 124 | 4.15 | |



Table D2. Dry Product Settings for Cappuccino (10 oz. cup)

| CHOCOLATE | | | | FREEZE DRY COFFEE | | | | FRESH BREW COFFEE | | | |
|--------------|-------------|--------------|----------------|-------------------|--------------|----------------|--------------|-------------------|----------------|--------------|--|
| Percent | Weight (gm) | Timing (sec) | Water Settings | | Percent | Water Settings | | Percent | Water Settings | | |
| | | | Volume (ml) | Timing (sec) | | Volume (ml) | Timing (sec) | | Volume (ml) | Timing (sec) | |
| 15 (default) | 6.2 | 0.95 | 60 | 2.95 | 85 (default) | 166 | 8.70 | 85 (default) | 185 | 6.65 | |
| 20 | 8.0 | 1.30 | 65 | 3.30 | 80 | 161 | 8.35 | 80 | 178 | 6.30 | |
| 25 | 9.8 | 1.60 | 70 | 3.60 | 75 | 155 | 8.05 | 75 | 172 | 6.10 | |
| 30 | 11.3 | 1.95 | 74 | 3.95 | 70 | 150 | 7.70 | 70 | 167 | 5.85 | |
| 35 | 13.6 | 2.25 | 80 | 4.25 | 65 | 143 | 7.40 | 65 | 159 | 5.65 | |
| 40 | 15.3 | 2.60 | 85 | 4.60 | 60 | 137 | 7.05 | 60 | 152 | 5.30 | |
| 45 | 17.1 | 2.90 | 90 | 4.90 | 55 | 131 | 6.75 | 55 | 144 | 5.10 | |
| 50 | 18.7 | 3.25 | 94 | 5.25 | 50 | 126 | 6.40 | 50 | 138 | 4.90 | |

Table D2. Dry Product Settings for Cappuccino (12 oz. cup)

| CHOCOLATE | | | | FREEZE DRY COFFEE | | | | FRESH BREW COFFEE | | | |
|--------------|-------------|--------------|----------------|-------------------|--------------|----------------|--------------|-------------------|----------------|--------------|--|
| Percent | Weight (gm) | Timing (sec) | Water Settings | | Percent | Water Settings | | Percent | Water Settings | | |
| | | | Volume (ml) | Timing (sec) | | Volume (ml) | Timing (sec) | | Volume (ml) | Timing (sec) | |
| 15 (default) | 7.6 | 1.15 | 64 | 3.15 | 85 (default) | 223 | 11.20 | 85 (default) | 231 | 8.26 | |
| 20 | 9.8 | 1.55 | 70 | 3.55 | 80 | 215 | 10.80 | 80 | 223 | 8.05 | |
| 25 | 11.8 | 1.95 | 76 | 3.95 | 75 | 208 | 10.40 | 75 | 215 | 7.70 | |
| 30 | 13.9 | 2.30 | 82 | 4.30 | 70 | 201 | 10.10 | 70 | 207 | 7.50 | |
| 35 | 16.1 | 2.70 | 87 | 4.70 | 65 | 193 | 9.70 | 65 | 201 | 7.15 | |
| 40 | 18.2 | 3.10 | 93 | 5.10 | 60 | 185 | 9.30 | 60 | 193 | 6.85 | |
| 45 | 20.4 | 3.50 | 99 | 5.50 | 55 | 178 | 8.90 | 55 | 185 | 6.60 | |
| 50 | 22.3 | 3.90 | 105 | 5.90 | 50 | 171 | 8.50 | 50 | 178 | 6.30 | |



CAFFÉ LATTE

Caffe Latte has a rich, robust coffee flavor. It is a full-bodied hot beverage with extra creamer, whipped to frothy perfection, with sugar optional. Try this recipe to expand your gourmet product selections and increase premium pricing opportunities.

ENTER THE SUPERVISOR CODE:





1. Press . The display shows: *ENTER CODE*. You must enter the four-digit supervisor code within 6 seconds to gain access.

NOTE

A new machine has a factory-set supervisor code of **0000**.

When you have entered the right code, you will hear two beeps and see *SUPERVISOR* in the display.

SET THE MACHINE TO VEND A LARGE "D" SELECTION:

1. Press the following keys: , , and . The CONFIGURE screen is displayed.
2. Press  twice. The display should look something like this:
1. ABCDEFGH. Make sure the "D" is displayed. If not, press "D" on the selection switch panel to display the "D".
3. Press  twice to return to the standby message.

SET UP YOUR SELECTION:

Follow the instructions in the **PRODUCT CONFIGURATION** section of the *Hot Drink Center Operator's Guide*.

1. Make sure the machine is configured to use 12 oz. cups.
2. Set up the 1D selection as follows:
 - a. Coffee: 17 grams
 - b. Sugar: 2.5 grams
 - c. Lightener: 5 grams
 - d. Water: 6 ounces (about 177 ml)
 - e. Steep time: 12.5 seconds
 - f. Whip: ON +

To get these measurements, refer to **PRODUCT CONFIGURATION**. See **COLLECTING DRY PRODUCT GRAM THROWS**, and perform test throws of the dry ingredients. See **COLLECTING WATER THROWS**, and perform test water throws.



EUROPEAN CAPPUCCINO

Introducing a great new blended drink called EUROPEAN CAPPUCCINO: First, a portion of cappuccino topping mix (or lightener) is dispensed, then layered on top is a small serving of strong coffee.

- 1. Replace product in the the soup (or international coffee) canister with the lightener or cappuccino topping mix.

- 2. Enter the Supervisor code:

Press . The display shows: *ENTER CODE*. You must enter the four-digit supervisor code within 6 seconds to gain access.

NOTE

A new machine has a factory-set supervisor code of 0000.

When you have entered the right code, you will hear two beeps and see

SUPERVISOR in the display. Press .

- 3. Reconfigure the machine:

- a. Press , then press  until the display shows *CONFIGURE*.

- b. Press . The configuration code is displayed: *WXYZ*, where W =

the machine type, X = 6th product configuration, Y = brewer configuration, and Z = canister mapping. You will be changing the number represented by X. The only way to do that is to change all four numbers, so at this time write down your configuration code so you will know where to start if you make a mistake.

- c. Replace "X" as follows:

| If your current value of X is: | Change it to: |
|--------------------------------|---------------|
| 1 | 5 |
| 2 | 6 |
| 3 | 7 |
| 4 | 8 |

For example: If your current configuration code is *1234*, you will enter the numbers *1634*. Your new drink will be selected with the H key. Valid selections are H3 (black) and H4 (with sugar). After the reconfiguration, timers for the topping mix or lightener are under the J selection, and the timers for the coffee serving are under the H selection. Now, you need to alter the water throw times for the two selections. Consult the following tables of throw times for suggestions for a starting point for your new drink.



COLLECTING WATER THROWS

National Vendors recommends the factory default times be used for water throws to ensure proper mixing. Table W1 gives the factory default water throw times for the various size cups and product selections.

WARNING
Water is **HOT!** Be careful.

For a non-brewed selection, collect the water throws as follows:

1. Place a cup in the cup delivery station.
2. Ensure the merchandiser is using the factory defaults for the cup sizes (refer to PRODUCT CONFIGURATION).
3. Initiate the water throw for a selection.
4. Remove the cup and pour the water into a graduated cylinder.
5. Refer to table W1 for the correct volume of water.
6. Adjust the water valve for that selection and repeat steps 3 through 5 until the correct volume of water is thrown.

For a brewed selection, collect the water throws as follows:

1. Remove water supply hose from the brewer as shown on the next page.
2. Place the end of the hose in a graduated cylinder.
3. Ensure the merchandiser is using the factory defaults per table W1 for the cup sizes (refer to PRODUCT CONFIGURATION).
4. Initiate the water throw for a selection.
5. Refer to table W1 for the correct volume of water.
6. Adjust the water valve for that selection and repeat steps 3 through 5 until the correct volume of water is thrown.

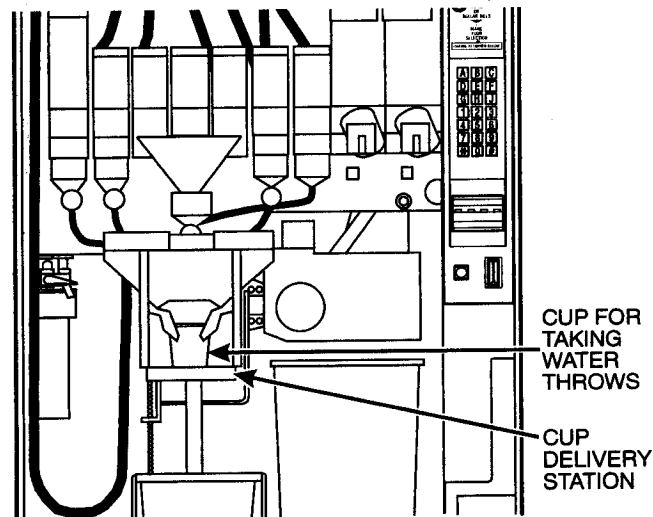
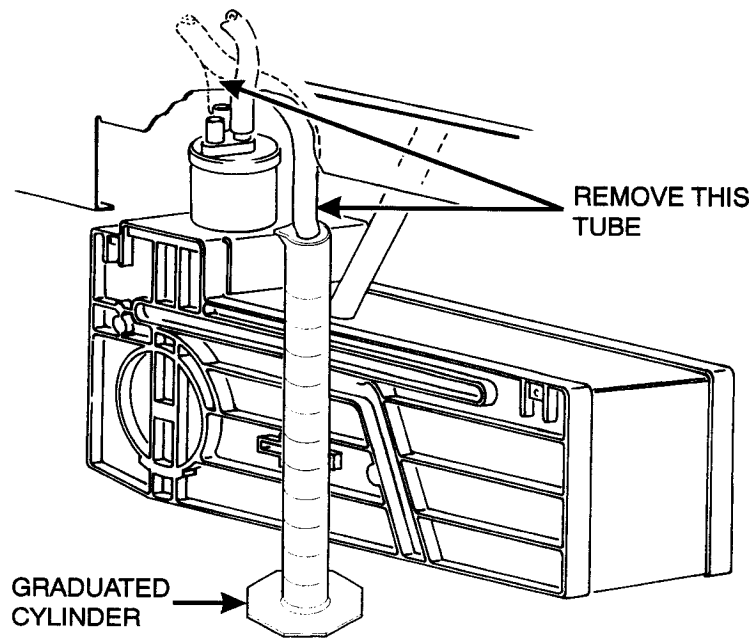



Table W1. Water Throw Default Times and Volumes

| Selection | Time (in seconds) per size cup | | | | | |
|---------------------|--------------------------------|-------------|-------------|--------------|--------------|--------------|
| | Volume (in ml) per size cup | | | | | |
| | 5 oz | 7 oz | 8 oz | 9 oz | 10 oz | 12 oz |
| A Fresh brew coffee | 4.50 130 | 6.40 190 | 7.50 220 | 8.20 240 | 9.00 265 | 11.00 315 |
| B Fresh brew decaf | 4.50 130 | 6.40 190 | 7.50 220 | 8.20 240 | 9.00 265 | 11.00 315 |
| A Freeze dry coffee | 5.90 120 | 8.20 170 | 9.65 200 | 10.20 210 | 11.70 240 | 14.80 305 |
| B Freeze dry decaf | 5.90 120 | 8.20 170 | 9.65 200 | 10.20 210 | 11.70 240 | 14.80 305 |
| C 6th Product | 5.90 100 | 8.20 140 | 9.65 170 | 10.20 180 | 11.70 200 | 14.80 240 |
| D Espresso | 2.95 60 | 4.10 85 | 4.85 100 | 5.10 105 | 5.85 120 | 7.40 153 |
| F Tea | 5.90 120 | 8.20 170 | 9.65 200 | 10.20 210 | 11.70 240 | 14.80 305 |
| G Chocolate | 5.90 100 | 8.20 140 | 9.65 170 | 10.20 180 | 11.70 200 | 14.80 240 |
| H Soup | 5.90 110 | 8.20 160 | 9.65 190 | 10.20 200 | 11.70 230 | 14.80 280 |







SET PRICES FOR INDIVIDUAL SELECTIONS

For this procedure, we will assume that the merchandiser is set up to vend two different sizes of cups. Also, the machine is configured to allow customers to vend a cup only (no drink). Here is an example of how to set prices for several different selections in this machine:

HELPFUL HINT

If most of the prices in your machine will be the same, perform the SET ONE PRICE FOR THE ENTIRE MACHINE procedure, then return to this procedure to set those prices which will be different.

1. Press . The display shows the maximum and minimum prices currently set in the machine.
2. Either press  to scroll through the selection list until you find the selection number you want.

OR

Go directly to the desired selection by pressing its letter.

To help you understand, here is an example. First, set the price for

the regular size C selection to \$0.65. Press 0C, or  until . . .



3. . . . the display shows **C .55**. (The price for the C selection is currently at \$0.55.) Enter the new price (65 cents) using the number keys.

Now, set the price for the large size D selection. Press 1D, or  until . . .

4. . . . the display shows **1D .75** This is the D selection price for the large size cup (the "1" means the large cup).
5. CONTINUE.





SET THE PRICE FOR A CUP ONLY

1. Press , then press  until the display shows **2 .XX**. "XX" represents the price for a cup only.
2. Enter the new price using the number keys.
3. CONTINUE.



SET ONE PRICE FOR THE ENTIRE MACHINE

1. Press . The display shows **** .XX .yy**. This is the maximum (XX) and minimum (YY) prices currently set in the machine.
2. Press . The display shows ******.



CAUTION

Setting all prices in the machine will **ERASE** currently set prices. If you are sure you want to do this, go to the next step. If not, go to step 5.

4. Enter a new price.
5. CONTINUE.



SET ONE PRICE FOR ALL REGULAR SIZE DRINKS

1. Press . The display shows **** .XX .yy**. This is the maximum (XX) and minimum (YY) prices currently set in the machine.
2. Press **0** (on the selection switch panel) and . The display shows **0***.



CAUTION

Setting these prices will **ERASE** currently set prices. If you are sure you want to do this, go to the next step. If not, go to step 5.

3. Enter a new price.
4. CONTINUE.



SET ONE PRICE FOR ALL LARGE SIZE DRINKS

1. Press . The display shows **** .XX .yy**. This is the maximum (XX) and minimum (YY) prices currently set in the machine.
2. Press **1** (on the selection switch panel) and . The display shows **1***.

CAUTION

Setting these prices will **ERASE** currently set prices. If you are sure you want to do this, go to the next step. If not, go to step 5.

3. Enter a new price.
4. CONTINUE.



SET THE TIME

1. Press . The display shows *TIME H.MM*. "H.MM" is the time of day currently set in the machine.
2. To change the time, just enter the time with the number keys using a 24-hour format (1300 = 1:00 pm).

NOTE

The new time will be displayed, but not updated in the system until



you press an arrow key or



3. CONTINUE.





SET THE DAY OF THE WEEK

1. Press , then press  until the display shows @ *SATWTFS*.
The currently set day of the week will be flashing. If it is correct, CONTINUE.
2. To change the day, press  until the correct day is flashing.
3. CONTINUE.



SET THE DATE AND YEAR

1. Press , and press  until the display shows *MM/DD YY*.
"MM/DD YY" is the month, date, and year currently set in the machine. The slash (/) means that the U.S. date format is being used.
2. If desired, enter a new month, date, and year with the number keys.
 - To change to the European date format (DD-MM YY), press .
The display is now shown with the date before the month, and the slash (/) is replaced by a dash (-) to avoid confusion.
3. CONTINUE.





CUSTOM TIME INTERVALS Times when normal vending is suspended in favor of special cases. For example, coffee could be discounted before working hours in the morning to favor early-arriving employees.



SET TIME-OF-DAY INHIBITED VENDING



Vending can be inhibited up to four times a day. This is useful when you don't want the machine used for any reason.

1. Press , then press  until the display shows **INHIB** -----.
2. Go to the TIME INTERVAL EDITING procedure for an example of how to set up time-of-day inhibited vending.



SET TIME-OF-DAY FREE VENDING



Vending can be free up to four times a day.

1. Press , then press  until the display shows **FREEV** -----.
2. Go to the TIME INTERVAL EDITING procedure for an example of how to set up time-of-day free vending.



SET TIME-OF-DAY DISCOUNT VENDING

Vending can be discounted up to four times a day. For example, this can be used to favor early-arriving employees.

1. Press , then press  until the display shows **DISCT** -----.
2. Go to the TIME INTERVAL EDITING procedure for an example of how to set up time-of-day discount vending.



TIME INTERVAL EDITING

You can select up to four times of day for each special vending period.

NOTE

If two or more of these time periods overlap, the interval with the highest priority will overrule the other(s). This order of precedence is:

1. INHIBIT
2. FREEVEND
3. DISCOUNT

For example, if a DISCOUNT time period is scheduled before the end of an INHIBIT time period, DISCOUNT does not begin until the INHIBIT interval has ended.

The time interval editing procedure is almost the same for the INHIBIT, FREEVEND, and DISCOUNT intervals. There is one difference for the DISCOUNT time interval, so that interval will be shown here.

1. The display shows *DISCT 1234* Press the number of the time interval you

want to edit, or  to edit time interval 1 (we'll use interval 1 for this example).

2. The display shows *1.DISCT ON* or *1.DISCT OFF*. This display tells you whether

your time interval (represented by X) is on or off. Press  to change the condition of the time interval.



NOTE

If you turn an interval ON, it must be edited. You can edit a time interval now, then turn it OFF until later.



3. Press . The display shows *1.DSCT XX* This is the discount percentage for this period. Enter a discount percentage of 25 with the number keys.

4. Press . The display shows *1.STRT X.XX* "X.XX" is the currently set start time. Enter a new start time (24-hour format) for this interval. To enter the time for 3:30 pm, enter **1530**.



5. Press . The display shows **1.STOP X.XX**. "X.XX" is the currently entered stop time. Enter a new stop time (24-hour format) for this interval. To enter a stop time of 6:00 pm, enter **1800**. You have now established a 25% discount that starts at 3:30 pm and ends at 6:00 pm.
6. Press . The display shows **1.@-----**. The dashes represent the days that this time interval is active. Pressing number keys 1 through 7 switches the days on/off. The days you select will appear in the display. Press **2, 4, and 6**. The display shows **1.@-W-F-**, meaning that the discount interval is only active on Monday, Wednesday, and Friday.
7. Press . The display shows ***.-----**. The dashes represent the selections affected by this time interval. Press the appropriate letter key to turn the selections ON or OFF. **NOTE** Selections not vended by your machine will not be displayed. Press **A, B, F, and H**. The display shows ***.AB---F-H**.

ADVANCED OPTIONS:

- Press  to enable all selections; press  to disable all selections.
- Press **0** or **1** to enable winners by cup size.

Press . The display shows either:

1.MESG OFF There is no custom message selected.

OR

1.MESG X. This means that custom message X (1 through 8) will be displayed during this time interval. Press the number key of the message you want displayed. Pressing **0** turns the message OFF for this time interval.

(You can also press  to scroll through the message list.)

YOU CAN SET UP THE CUSTOM MESSAGE BY FOLLOWING THE CUSTOM MESSAGE EDITING PROCEDURE.

9. CONTINUE.



STANDBY MESSAGE

The message that is displayed during normal vending periods when there are no out-of-service faults on the machine.



SELECT A STANDBY MESSAGE

1. Press , then press  until the display shows **STANDBY *MX***.

"X" represents the current message number selected for the standby message. Two dashes mean that the factory-set message is selected.

2. To select a message, just press the corresponding number (1 through 8). To display the factory-set message, press 0.

OR

Press  to scroll through all eight messages and the factory-set message.

3. CONTINUE.



SELECT AN OUT-OF-SERVICE MESSAGE

1. Press , then press  until the display shows **SERVICE *XX***.

"XX" represents the current message number selected to display when the machine is out-of-service. Two dashes mean that the factory-set message is selected.

2. To select a message, just press the corresponding number (1 through 8). To display the factory-set message, press 0.

OR

Press  to scroll through all eight messages and the factory-set message.

3. CONTINUE.



SELECT A FREEVEND MESSAGE

1. Press , then press  until the display shows **FREEVEND XX**.

"XX" represents the current message number selected for the message that displays when the machine is in the freevend mode. Two dashes mean that the factory-set message is selected.

2. To select a message, just press the corresponding number (1 through 8). To display the factory-set message, press 0.

OR

Press  to scroll through all eight messages and the factory-set message.

3. CONTINUE.



EDIT CUSTOM MESSAGES

- 1. Press  , and press  until the display shows *EDIT MSG'S*.

Press the number of the message you want to edit. *MESSAGE X* is displayed (X represents the message number you pressed).

- 2. Press  . The message text is displayed with the first character flashing.

- 3. To view the message, press  . The message scrolls across the display.

To stop the scrolling, press .

- 4. When the character you want to change is flashing, either enter it directly, or

use  and  to step through the character set until the desired

character is displayed. Use the arrow keys to highlight different characters. See the section on the next page for an explanation of special keys and the character set.

SHORTCUT

Instead of stepping through the whole character set to enter a letter that is not on your keypad, enter one close to the one you want, then step to it. Example: If you want to enter an L, first press J on the selection switch panel. Then press



twice. Your L should now be displayed.

THE END OF MESSAGE CHARACTER

This is the most important character in your message, because it tells the machine when the message is ended. If you don't use this character, your message will be followed by a bunch of zeros. This character can be selected either from the character set or by a direct key entry (see the next page).





ENTERING YOUR MESSAGE

You will be using a combination of special keys and the keys on the selection switch panel to enter your message. Pressing the keys on the selection switch panel will enter the character shown on that key. Most of the keys on the service keypad have a special purpose to help you create and edit your messages:

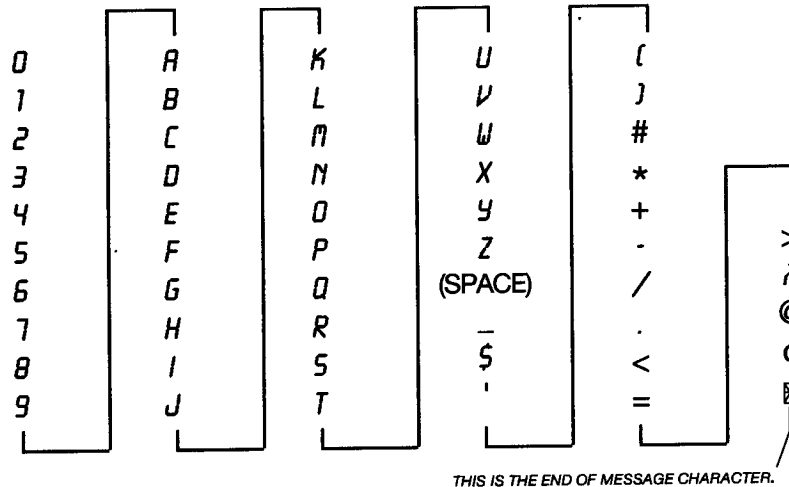

- | | | | |
|---|---|--|--|
| <div style="border: 1px solid black; padding: 2px; margin-bottom: 5px;">1 PRG</div> <div style="border: 1px solid black; padding: 2px; margin-bottom: 5px;">4 MESSAGE CONTROL</div> <div style="border: 1px solid black; padding: 2px; margin-bottom: 5px;">7 PROPERTY CONTROL</div> <div style="border: 1px solid black; padding: 2px; margin-bottom: 5px;">8 TIME OF DAY</div> <div style="border: 1px solid black; padding: 2px; margin-bottom: 5px;">EDIT</div> <div style="border: 1px solid black; padding: 2px; margin-bottom: 5px;">↓</div> <div style="border: 1px solid black; padding: 2px; margin-bottom: 5px;">↑</div> <div style="border: 1px solid black; padding: 2px; margin-bottom: 5px;">3 P1 +</div> <div style="border: 1px solid black; padding: 2px; margin-bottom: 5px;">6 P2 -</div> | <p>Inserts an R at the flashing character.</p> <p>Inserts an S at the flashing character.</p> <p>Inserts a T at the flashing character.</p> <p>Repeats the letter to the left of the flashing character.</p> <p>"Pages" through the message, ten characters (one screen) at a time.</p> <p>Steps forward and backward through the message, one character at a time.</p> <p>Steps forward and backward through the character list, one character at a time.</p> | <div style="border: 1px solid black; padding: 2px; margin-bottom: 5px;">2 FREE READ INSERT</div> <div style="border: 1px solid black; padding: 2px; margin-bottom: 5px;">5 DATA RECALL DELETE</div> <div style="border: 1px solid black; padding: 2px; margin-bottom: 5px;"># CODE CLEAR</div> <div style="border: 1px solid black; padding: 2px; margin-bottom: 5px;">9 PAK</div> | <p>Inserts a space at the flashing character.</p> <p>Deletes the current character and closes up the space.</p> <p>Deletes the current character and leaves the space.</p> <p>Enters the special "end of message" character, which denotes the end of the message.</p> |
|---|---|--|--|

THE CHARACTER SET





TEST VEND SELECTIONS AND VERIFY CREDIT ADDED

1. Press  the display shows *TEST .00*. You may now test vend selections.
2. To test vend selections without dropping a cup, press . The display shows *TEST.MC .00*. No cups will drop during the rest of your test vend session. If desired, you may place money in the machine.

In either case, if you insert money into the machine, the zeros in the display will be replaced with the amount of the credit.





NOTE

You may make one more test vend if you close the door while still in TEST VEND mode.

3. CONTINUE.



TEST THE DISPLAY

1. Press , then press  until the display shows *DSPLY TEST*.
2. Press  to light all display segments; press  to turn them off.
3. Pressing a number key on the maintenance keypad, or any key on the selection switch panel causes all segments to display that character.



NOTE

To help differentiate the two keypads, a number from the maintenance keypad has an apostrophe after it: *1'*. A number from the selection switch panel has a period after it: *1.*



4. CONTINUE.





 **TEST THE CUP MECHANISM**

1. Press  then press  until the display shows *CUP TEST*.
2. You can test the cup mechanism one of several ways:
 - a. Press **1**. A cup is dispensed from ring 1.
 - b. Press **2**. A cup is dispensed from ring 2.
 - c. Press . One cup is dropped from each ring.
3. CONTINUE.

 **TEST THE AUTOMATIC DOOR (OPTIONAL)**

1. Press  then press  until the display shows *DOOR TEST*.
2. Press  to test the automatic delivery door. The door will open, then close after one second.
3. CONTINUE.

 **TEST THE WHIPPERS**

1. Press  then press  until the display shows *WHIP TEST*.
2. Press the whipper number (1 = "C" selection whipper, 2 = whipper below main condiment mixing bowl, 3 = soup whipper, or 4 = chocolate whipper) you want to test.

OR

Press the letter of a selection containing a whipper.
- In either case, *WHIP X* is displayed while the whipper under test ("X") runs.
3. CONTINUE.



TEST THE GRINDER(S)

1. Press , then press  until the display shows *GRIND TEST*.

WARNING

Keep away from the grinder during this test. Do not test a grinder that is not mounted on its canister. Otherwise, you could be HURT.



2. Do either of the following:
 - a. Press the grinder number on the selection switch panel or the service keypad
 - OR -
 - b. Press a selection letter (a number is not needed) on the selection switch panel. The grinder associated with that selection will run.

In either case the display shows: GRIND X (X = grinder number) while the grinder is running.

3. Repeat step 2 or CONTINUE.



TEST THE AIR COMPRESSOR

1. Press , then press  until the display shows *AIR TEST*.
2. Press  to test the air compressor.



NOTE

If the brewer is in the BREW position at the start of this test, the compressor runs for 18 seconds. This allows you to evacuate a full brewer barrel. Otherwise, it runs for 2 seconds.

3. CONTINUE.



TEST THE BREWER

1. Press , then press  until the display shows **BREW TEST**.
2. Press  to test each brewer position:

WARNING

Keep away from the brewer mechanism while it is operating. Coming into contact with moving parts could injure you.



- a. **BREW 'R BREW** The brewer is in the BREW position.
 - b. **BREW 'R FLIP** The brewer is in the FLIP position.
 - c. **BREW 'R HOME** The brewer is in the HOME position.
3. CONTINUE.



RINSE ALL MIXING BOWLS

WARNING

Very hot water will be dispensed in this test. Coming into contact with hot water will HURT!



1. Press , then press  until the display shows **BOWL RINSE**.
 2. Press  to rinse all bowls. **RINSING** is displayed.
3. CONTINUE.



RINSE THE BREWER



WARNING

Very hot water will be dispensed in this test. Coming into contact with hot water will HURT!

1. Press , then press  until the display shows *BREW RINSE*.
2. Press  to rinse the brewer. The brewer cycles, and *RINSING* is displayed.
3. CONTINUE.



FILL THE TANK

1. Press , then press  until the display shows *TANK.FILL*.
2. Press . This clears any tank error and starts filling the tank, if necessary.

NOTE

If it is taking a long time to fill the tank *AND THERE ARE NO LEAKS*, you may see *TANK ERR* in the diagnostic list again. Just press



again after making sure there are no other problems, such as a restriction in the water inlet line or a clogged water filter.

3. CONTINUE.



TEST VARIOUS SENSORS AND SWITCHES

1. Press , then press  until the display shows *IN.XXXXXX*. The





X's in the display will be replaced by the following place holders:

MKPHL12, defined as follows:

| | |
|----------------------------------|----------------------------------|
| M = mug/cup sensor (if equipped) | K = freevend keyswitch |
| P = waste pail switch | H = high water tank level switch |
| L = low water tank level switch | 1 = ring 1 cup sensor switch |
| 2 = ring 2 cup sensor switch | |

2. Actuate each switch or sensor to test its function. As you actuate each input, the display element representing that switch blinks on. Releasing the switch causes that element to blink off again, and be replaced by a dash.
3. CONTINUE.

PAYOUT COINS

1. Press . If a dumb mech was selected, the display shows *NDQ =123*; if an MDB mech was selected the display shows *PAY 123*.
2. Press . A dumb mech pays out one *Nickel*; an MDB mech pays a coin from tube 1. Press . A dumb mech pays out one *Dime*; an MDB mech pays a coin from tube 2. Press . A dumb mech pays out one *Quarter*; an MDB mech pays a coin from tube 3.
3. To continuously pay out coins, hold down the appropriate key.
4. CONTINUE.



SET FREEVEND OPTIONS

1. Press  until one of the following is displayed:

FREE OFF - Normal vending mode. No items are on freevend. A closure on the keyswitch input causes the machine to go out of service.

- OR -

FREE ALL - All items are on freevend. The credit display shows
NOMONEYREQUIRED

A closure on the keyswitch causes the machine to go out of service.

- OR -

FREE W/KEY - All items are freevended while there is a closure on the keyswitch input. Normal cash sales are supported when the keyswitch input is open. If the free vend code (selected under SUPERVISOR MODE) is not 0000, the code must be entered first.

- OR -

FREE ONCE - A closure on the keyswitch input causes only the next item to be freevended. Coin mechanism errors are ignored. this state is designed for card or token systems where one item is vended per token. Normal cash sales are also supported.

2. Press  until the option you want is displayed.

3. CONTINUE



VIEW MACHINE ID NUMBER



1. Press , then press  until the display shows **I.D. XXXXXX**.

The X's represent the 6-digit machine ID number.

2. CONTINUE.







VIEW NONRESETTABLE SALES AND VEND DATA



1. Press . The display shows **NR\$ XX.XX**. "XX.XX" is a dollar and cents figure showing the total of all sales in the machine. This is a running total, and is not resettable.
2. Press . The display shows **NR X**. "X" is the total number of vends made by the machine. This is a running total, and is not resettable.
3. CONTINUE.

VIEW DATA THREE DIFERENT WAYS

Paid sales and vends can be viewed three different ways: By whole machine, by selection type, and by individual selection. The first screen of the data item shows its machine total.



- To view the data by selection type, press the letter of the type you want to see. For example, pressing **A** shows you the total sales and vends for the combined regular and large size cups of the A selection. You can then press  and  to see data for all the active selection types.
- To view the data by individual selection, press the letter and number of the selection you want to see. You can then press  and  to see data for all the active selections.
- If viewing data by individual selection, press  to view the date and time of the last vend of that selection.

VIEW TOTAL PAID SALES

1. Press , then press  until the display shows ****\$ XX.XX**. "XX.XX" is a dollar and cents figure showing the total of all **PAID** sales in the machine (as opposed to unpaid sales like winner and free vends). This is the total since the last time it was cleared.
2. If desired, view this data by cup size and individual selection.
3. CONTINUE.





VIEW CARD READER PAID SALES (NOT SHOWN IF ZERO)

1. Press , then press  until the display shows ****\$ XX.XX**.
2. Press . The display shows **DBT XX.XX**. "XX.XX" is the amount of money collected from card reader sales.
3. CONTINUE





VIEW TOTAL PAID VENDS

1. Press , then press  until the display shows **** XX**. "XX" is the total number of paid vends for the entire machine.
2. If desired, view this data by cup size and individual selection.
3. CONTINUE



CLEAR ALL RESETTABLE DATA

1. Press . The display shows **NR\$ XX.XX**. This is a running total, and is not resettable.
2. Press and hold . Two beeps sound and the display shows **CLEARING** momentarily, and then changes to **FINISHED**. All data is cleared.
3. CONTINUE.

**CLEAR PAID SALES DATA ONLY**

1. Press , then press  until the display shows ****\$ XX.XX**.

"XX.XX" is a dollar and cents figure showing the total of all **PAID** sales in the machine (as opposed to unpaid sales like winner and free vends). This is the total since the last time it was cleared.

2. Press and hold . Two beeps sound and the display shows

CLEARING momentarily, and then changes to **FINISHED**. All paid sales data is cleared; other data is not cleared.

3. CONTINUE.

**VIEW AMOUNT IN COIN BOX (NOT SHOWN IF ZERO)**

1. Press , then press  until the display shows **CBX XX.XX**.

"XX.XX" is the dollar and cents amount in the coin box.

2. CONTINUE.

**VIEW AMOUNT IN VALIDATOR (NOT SHOWN IF ZERO)**

1. Press , then press  until the display shows **DBV XX.XX**.

"XX.XX" is the dollar amount in the bill stacker.





2. Press  to show the quantities of bills in the stacker. For example, the display shows **\$01 20**, meaning that there are 20 dollar bills in the bill stack-

er. Press  again to show the quantities of other bills, such as \$5s, \$10s, or \$20s.

3. CONTINUE.







VIEW FREEVEND SALES BY TIME INTERVAL (NOT SHOWN IF ZERO)

1. Press , then press  until the display shows **_0\$ XX.XX**.
2. Press , then press  until the display shows **1.FRV .00**. This is the total sales for freevend interval 1, shown even if zero.
3. Press  to view intervals 2 through 4.
4. CONTINUE.







VIEW DISCOUNT SALES BY TIME INTERVAL

1. Press , then press  until the display shows ****\$ XX.XX**.
2. Press . The display shows **1.DSC .00**. This is the total sales for discount interval 1 (not shown if zero).
3. Press  to view intervals 2 through 4.
4. CONTINUE.







VIEW FREE VENDS (NOT SHOWN IF ZERO)



1. Press , then press  until the display shows **_0\$ XX.XX**.
2. Press , then press  until the display shows **FRV XX.XX**.
"XX.XX" is the total machine-wide freevends, shown even if zero.
3. CONTINUE.





VIEW WINNERS (NOT SHOWN IF ZERO)

1. Press , then press  until the display shows **_D\$ XX.XX**.
2. Press , then press  until the display shows **WIN XX.XX**.
 "XX.XX" is the total machine-wide winners, shown even if zero.
3. CONTINUE.



VIEW TIME DATA

1. Press , then press  until the display shows **TIME DATA**.
2. Press . The following message scrolls across the display:

MAIN.1237M 01/30 10.13

 This example shows the latest time interval the main (machine) door was open (1). It was open for 237 minutes, and was opened on January 30 (01/30) at 10:13 am (10.13). Press . If applicable, similar displays will appear for intervals 2, 3, and 4. Otherwise, go to the next step.
3. Press . The following message scrolls across the display:

LASTPOWER 01/30 13.51 FOR 00. 0.23

 This example shows that the last time the machine lost power was on January 30 (01/30) at 1:51pm (13.51) for zero days, zero hours, and 23 minutes (00. 0.23).
4. Press . The following message scrolls across the display:

LONGS.TPOWER 01/30 10.58 FOR 00. 2.47

 This example shows that the longest time the machine was without power was on January 30 (01/30) at 10:58am (10.58) for zero days, 2 hours and 47 minutes (00. 2.47).



5. Press . The following message scrolls across the display:

FULL CLEAR 01/30 8.58

This example shows that the last time resettable sales was fully cleared was on January 30 (01/30) at 8:58am (8.58).

6. Press . The following message scrolls across the display:

TIME SET 01/30 9.15

This example shows that the last time the time or date was set was on January 30 (01/30) at 9:15 am (9.15).

7. Press . The following message scrolls across the display:

PRICE SET 01/30 9.42

This example shows that the last time prices were set was on January 30 (01/30) at 9:42 am (9.42).

8. CONTINUE.

NOTE

Refer to VIEW DATA THREE DIFFERENT WAYS to view the date and time of the last vend of that selection.



VIEW TOTAL UNPAID SALES

NOTE

This does not appear if the total of unpaid sales is zero.



1. Press , then press  until the display shows ***_0\$ XX.XX***.

"XX.XX" is the total unpaid sales (free vends, winner vends, 100% discounts, zero price vends) for the entire machine.



2. If desired, view this data by cup size and individual selection.
3. CONTINUE.



 **VIEW TOTAL UNPAID VENDS**





1. Press  , then press  until the display shows **_0 XX**. "XX" is the total number of unpaid vendes for the entire machine.
2. If desired, view this data by cup size and individual selection.
3. CONTINUE.

 **VIEW NUMBER OF TEST VENDS (NOT SHOWN IF ZERO)**

1. Press  , then press  until the display shows **TST X**. "X" is the number of test vendes.
2. If desired, view this data by cup size and individual selection.
3. CONTINUE.

 **VIEW SALES DATA BY PRICE**

You can view the total sales of each separate price in the machine.

1. Press  , then press  until the display shows ****\$ XX.XX**.
2. Press  . The display shows the lowest price followed by the dollar sales of all selections costing that price.
3. Press  to step through all the prices set in the machine.
4. CONTINUE.



DISPLAY DIAGNOSTIC MESSAGES

1. Press . If faults are not present on your machine, **NO ERRORS** is displayed.

2. The following displays will appear when the appropriate fault condition exists.

Press  to display all applicable fault messages:

- KEYPAD XY** "Key(s) "X" and "Y" are stuck. Try unsticking keycaps or replacing key membrane."
- ROM ERROR** ROM checksum error. Replace EPROM or main controller assembly.
- RAM ERROR** RAM error. Attempt RAM clearing by pressing CLEAR key. Replace RAM or main controller assembly.
- CONFIG ERR** Configuration error. Recheck configuration settings.
- TANK ERR** Tank failed to be filled or refilled.
- RING 1,2** The cup ring is jammed (ring 1 and/or 2)
- NOT'R 1A 1B** Cup turret motor 1A or 1B is jammed. Remove all cups and close door. Perform the cup test.
- NO CUPS 1** Out of cups.
- BREW JAM** The brewer is jammed.
- WASTE PAIL** The waste pail is full.
- LOW WATER** The water level in the tank is low.
- COLD TANK** Water is too cold to vend.
- NO SENSOR** Illegal temperature reading. Check tank sensor. Check harnessing for broken or bad connections.
- WHIP 1,2,3** Whipper motor failure (motor 1, 2 or 3)
- DOOR JAM** The automatic delivery door is jammed.
- CHK PRICES** Illegal price detected.
- LOCKS SET** All selections are locked (see PRODUCT CONFIGURATION).
- NONE READY** All selections are out of service. Check time of day inhibits and lockouts.
- NO MECH** Coin mech not detected - machine will not operate if configured for coin mech.
- MECH.COMM** Incomplete coin mech communications -- check harness.
- MECH.SENSOR** ... Coin mech reporting a bad tube sensor - replace mech.





- MECH.JAM** One or more coin tubes are jammed. Pay a coin from each tube until the jam is cleared.
OR
Coin is jammed in the acceptor section. Check the coin mechanism for a jam in this position. Insert coins and cycle machine power OFF and then ON.
- MECH.ROM** Replace the coin mechanism.
- MECH.ACCEPT** Coin mechanism acceptor section is unplugged from the main body of the coin mech. Connect the cable and cycle machine power OFF and then ON.
OR
The vending machine is telling the coin mech not to accept any coins.
- DBV.COMM** Incomplete bill validator communications -- check harness.
- DBV.SENSOR** One of the sensors in the bill validator has failed. The unit will disable itself until the error is corrected. Check for bill stuck in the acceptance path. If no bill is present, replace the validator. Cycle machine power OFF and then ON.
- DBV.ROM** ROM checksum failure. The unit will disable itself until the error is corrected. Replace the validator.
- DBV.JAM** A bill is jammed in the acceptance path. The unit will disable itself until the error is corrected. Remove bill stuck in the acceptance path. Cycle machine power OFF and then ON.
- DBV.MOTOR** One of the motors has failed. The unit will disable itself until the error is corrected. Check for bill stuck in the acceptance path. If no bill is present, replace the validator. Cycle machine power OFF and then ON.
- DBV.STACKR** The stacker is open or removed. The unit will disable itself until the error is corrected. Install the stacker correctly.
OR
The stacker is full of bills. Remove bills from the stacker.
- DBV.ACCEPT** The vending machine is telling the bill validator not to accept any bills. Check the enabled channels of the bill validator.
- CARD.F.COMM** Incomplete card reader communications - check cables. The card reader is not operational.
- CARD.COMM** Incomplete card reader communications. Check cables or replace unit.
- CARD.ERR** Card reader is indicating it has a problem.
- CARD.F.ERR** Card reader is indicating it has failed. Replace unit.
- CARD.ERRXX** Card reader has an error and indicates code XX. The code is defined by the card reader manufacturer. To correct, contact card reader manufacturer. The unit is still operational.
- CARD.F.ERRXX** .. Card reader has failed and indicates code XX. The code is defined by the card reader manufacturer. To correct, contact card reader manufacturer.



CARD.F.JAM Card reader has failed because card is jammed in the unit.
Remove the jammed card.

CARD.SERV Card reader requires service. The unit is still operational.



 **CHANGE MACHINE ID NUMBER**

1. Follow the steps in **GAIN ACCESS TO THE SUPERVISOR MODE**.
2. Press , then  until the display shows *I.D. XXXXXX*. The X's represent the 6-digit machine ID number.
3. Using the number keys, enter a new ID number.
4. CONTINUE.



 **VIEW THE WATER TANK TEMPERATURE**

1. Press . The display shows *TEMP XX F*. This is the current water tank temperature (in degrees F or C, depending upon your choices).
2. CONTINUE.

 **VIEW THE CURRENT SOFTWARE VERSION NUMBER**

1. Press , then press  until the display shows *VER XXXX*. This is the current software version number.
2. CONTINUE.

 **VIEW THE MACHINE CONFIGURATION CODE**

1. Press , then press  until the display shows *CONF WXYZ*. This is the machine configuration. (See **PRODUCT CONFIGURATION** for an explanation of "W", "X", "Y", and "Z".)
2. CONTINUE.



VIEW THE SELECTION CONFIGURATION

1. Press , then press  until the display shows *D.ABCDEFGH*.



This shows which selections are available for sale and setup for regular size drinks. If one or more of the letters in the display are replaced by dashes (-), that selection is unavailable.

2. Press . The display shows *1.ABCDEFGH*. This shows which selections are available for sale and setup for large size drinks. If one or more of the letters in the display are replaced by dashes (-), that selection is unavailable.

This shows which selections are available for sale and setup for large size drinks. If one or more of the letters in the display are replaced by dashes (-), that selection is unavailable.

3. CONTINUE.

VIEW CUP ONLY STATUS

1. Press , then press  until the display shows *CUPVND ON* or *CUPVND OFF*. This shows whether or not the machine will vend a cup only (no drink).

2. CONTINUE.

VIEW THE SELECTED WHIPPING OPTION

1. Press , then press  until the display shows either :



J WHIP (Selections programmed for optional whipping will be whipped only if J is pressed.)

OR

J NO WHIP Selections programmed for optional whipping will **NOT** be whipped only if J is pressed.

2. CONTINUE.

VIEW THE AUTOMATIC DELIVERY DOOR OPTION

1. Press , then press  until the display shows either *DOOR ON* or

DOOR OFF. This shows whether or not the optional automatic delivery door is enabled.

2. CONTINUE.



SANITATION

Basics

INTRODUCTION

Anybody who services vending machines must use proper sanitizing procedures. Health regulations require that hands be clean when cups, commodities, and food-contact parts are handled or serviced.

In addition, Federal and State Health Departments require regular cleaning and sanitizing procedures for food contact parts.

The information in this section will explain how to clean and sanitize the merchandiser on a day to day basis. A clean and well maintained merchandiser will provide a better product and greater safety for your customers.

CLEANING AND SANITIZING -- WHAT'S THE DIFFERENCE?

Clean means "free of visible soil". In cup vending machine servicing, cleaning is also done to maintain product quality and to remove food soils, oils, and mineral stains that could affect product taste, aroma, and appearance.

Sanitizing means the reduction, to safe levels, of the number of disease-causing bacteria that remain on the surface **after** cleaning. Therefore, cleaning and sanitizing are done in separate steps, as prescribed by health regulations and good industry practice.

When you sanitize you create a healthy and hygienic condition. This leads to wholesome food, which in turn leads to satisfied customers.

SANITIZING IS NO SUBSTITUTE FOR A GOOD CLEANING

HOW DO I SANITIZE?

You can sanitize by using either of these two methods:

Chemicals: The object to be sanitized is treated with a bactericidal compound.

Heat: Raise the temperature of the object high enough to kill bacteria. Water must be at least 170° F.

Hot brew water (if available) is an acceptable sanitizer. When food contact surfaces are washed and/or rinsed, use the hot water available in the machine.

Turn the machine off before using water on the machine.

In either case, the object must be thoroughly clean and completely rinsed in order for the sanitizing process to work. Caked-on soils not removed by cleaning, for example, may shield bacteria from a sanitizing solution.

**A GOOD PLACE TO START -- YOUR SANITATION KIT**

You need to be sure that each machine is clean, safe, and functioning when you leave it. In order to properly do this, you need to have a complete set of the right tools. In addition to the screwdrivers, pliers, and test equipment necessary to repair a machine, you need to have the tools to clean the machine.

Here is a checklist of the items needed for a good sanitation kit:

- Sanitation pail
- Tube and nozzle brushes for food contact surfaces
- Utility brush for dry spillage around canisters, etc.
- Disposable towels, wet-strength and lint-free

NOTE

Wiping with towels can recontaminate sanitized food-contact parts. Therefore, towels should not be used to dry food-contact surfaces. Instead, these parts should be air dried.

- Spray detergent, diluted to desired strength
- Urn cleaner packets for coffee stains and oils
- Odor control chemicals for pails
- Replacement parts (if the exchange method is used)
- Cabinet polish or window cleaner for the outside of the machine

Feel free to add some items to this list. For example, you may want to use a portable vacuum cleaner.



SANITATION PROCEDURES

Refer to the recommended cleaning and sanitation interval table on the final page of this section. For each item, complete the procedure as outlined here.

Food-Contact Parts

NOTE

All food-contact parts must be cleaned and sanitized. Air dry, do not wipe dry.

Ingredient Canisters - Empty and wash the canisters, augers, and spouts. Sanitize with hot water and allow to air dry completely before returning to cabinet.

Mixing Bowls - The inside of all mixing bowls can be rinsed by performing the "Bowl Rinse" operation as outlined in the Programming section of this manual.

If needed, remove mixing bowls from the dry ingredient shelf. Wash the mixing bowl lids and sanitize with hot water. Allow to completely air dry before reassembling.

Whipper Lids and Impellers - Remove lids and impellers from the whipper housings, wash the lids and impeller housing. Sanitize with hot water and allow to air dry before reassembling.

Beverage Discharge Nozzles - Disconnect the beverage dispensing tube from the nozzles. Remove the nozzles from the mounting bracket. Remove the cap from the nozzle, wash clean and sanitize the nozzles and cap. Refer to the tubing connection diagram for proper routing.

Brewer, Brewer Basket, and Brewer Funnel - The tubing and brewer may be sanitized by performing the BREW RINSE operation as outlined in the programming section. The machine features an automatic brewer sanitizing feature also described in the programming section.

At times, it may be necessary to wash and sanitize the individual brewer parts. If so, disconnect the tubes from the brewer manifold. Remove the brewer barrel and manifold assembly from its support. Remove the brewer basket and funnel assemblies.

Thoroughly wash all parts using soap and water. Sanitize by rinsing thoroughly with hot water.

Coffee Chutes - Remove the metal chute(s), wash clean, and sanitize by rinsing with hot water. Air dry before reinstalling.

Condiment Chute Assembly - Remove the condiment chute and cover from the condiment canisters. Thoroughly wash all parts using soap and water. Sanitize by rinsing thoroughly with hot water.



Non Food-Contact Parts

Cup Delivery Compartment - Remove the compartment from the merchandiser. Wash clean and rinse with hot water.

Exhaust Fan Filter - Remove the filter from its housing. Wash with soap and water, rinse, wring dry, and replace into housing.

Waste Pail - Empty, wash, and rinse with hot water. Sprinkle detergent powder in the bottom of the pail to help control odors.

Ingredient Rinse Tray - Remove product canisters. Wash and rinse with hot water. Allow to air dry.

OVERALL CLEANING

Inspect your merchandiser both inside and out. Be sure to check corners and all less visible parts of the merchandiser.

Clean where needed.

Allow the inside of the cabinet to dry thoroughly before you close the door.

National Vendors recommends using the following supplies:

A commercial glass cleaner on the glass in the cabinet door.

A mild detergent and warm water on the cabinet, brewer, and other NONELECTRICAL components.

CAUTION

The plastic parts in your merchandiser should be cleaned with mild detergent and warm water. The use of other cleaning agents may damage the material, and should be avoided.

PREVENTIVE MAINTENANCE CLEANING

Periodically, you should visually inspect your merchandiser's hot water tank for excessive lime and scale buildup. This buildup on the tank walls, water valves, and heater element will vary dramatically, depending upon water quality. You should develop a cleaning and deliming schedule based on the apparent local water quality.

NOTE

To aid in removing scale from your merchandiser, National Vendors has a service kit available: part number 6400080. In addition, if your machine has the Everpure water inlet filter system option, a second kit (part number 6400086) is also available.

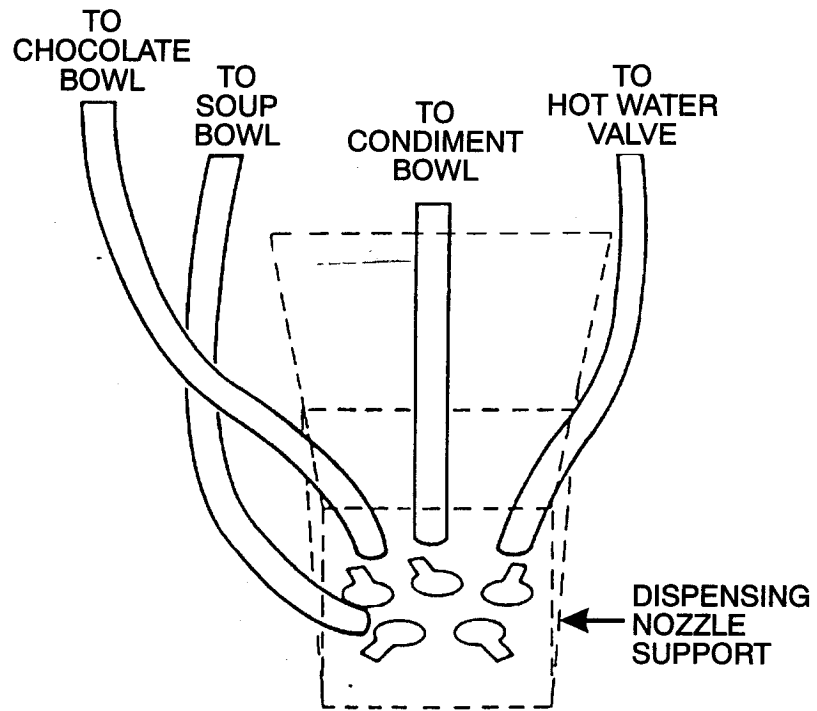

TUBE ROUTING DIAGRAM



RECOMMENDED CLEANING AND SANITATION INTERVALS

| ITEM | DAILY | WEEKLY | MONTHLY | QUARTERLY | SEMI-ANNUALLY |
|---|-------|--------|---------|-----------|---------------|
| Ingredient Canisters | C | | S | | |
| Mixing Bowls | C | S | | | |
| Whipper Funnels and Impellers | C | S | | | |
| Beverage Discharge Nozzles | C | S | | | |
| Brewer, Brewer Basket and Brewer Funnel | C | S | | | |
| Bean Grinder Coffee Chutes | C | S | | | |
| Bean Grinder Housing | | S | | | |
| Brewer Mechanism | | C | | | |
| Cup Delivery Compartment | C | | | | |
| Exhaust Fan Filter | | C | | | |
| Grounds Pail | C | | | | |
| Waste Pail | C | | | | |

S = Sanitize at this interval





C = Clean only at this interval



APPENDIX A. THE FREE VEND KEYSWITCH OPTION

The free vend keyswitch allows someone to set up free vending without needing to open the door.

It is a good idea to establish a free vend code. This will prevent an unauthorized person from setting the machine to free vend, even if they have a key.

1. Press . Enter your 4-digit supervisor code. Press .
2. Press  again, then press  until the display shows *FREE XXXX*. Enter a 4-digit free vend code.

NOTE

To keep the user from having to enter a code, you can enter 0000 as your code. See the steps below for details.

3. Press  until you have left the function.

USING THE FREE VEND KEY SWITCH:

If you have set your freevend option to FREE W/KEY:

1. Place your key in the free vend keyswitch and turn it to the right. (If the keyswitch is already turned to the right, turn it to the left, then back to the right.) The display shows: *ENTER CODE*.

NOTE

If your freevend code is set to 0000, you will not see this display. Skip to step 3.

2. Enter your 4-digit freevend code. If you do this successfully within 6 seconds, you will hear two beeps, and the display shows: *UNLOCKED*.
3. The display shows *NO MONEY REQUIRED* (or whatever custom message you set up for the freevend period). Remove your key. All vends are free until the keyswitch is turned to the left again.
4. To take the machine off free vend, insert your key, turn the keyswitch to the left, and remove the key.

If you have set your freevend option to FREE OFF or FREE ALL:

1. If the freevend key is turned to the right, the machine will go out of service.



THIS PAGE INTENTIONALLY LEFT BLANK



APPENDIX B. THE INFRARED MUG/CUP SENSOR

APPENDIX B. THE INFRARED MUG/CUP SENSOR

The infrared mug/cup sensor can sense the presence of a mug or cup without using moving parts.

Indicator light

The sensor is equipped with an indicator light. This light will help you get the best results from the infrared mug/cup sensor.

Under these conditions:

- Machine door open
- Cup station in place
- No cup in the station

The indicator light should be off. If it is on, it is indicating improper cup station alignment or excessive sensor sensitivity.

Under these conditions:

- Machine door closed
- Cup station in place
- No cup in the station

Press any letter on the selection switch panel, for example, **A**. Only the letter **A** should be showing in the message display. If "**A MUG**" is displayed, it indicates one or more of the following:

- Improper cup station alignment
- Excessive sensitivity (the sensor is sensing the delivery door)
- Cup station lens is not clean

Cleaning

As indicated in the Sanitation section, you should remove the cup station to clean it. Pay particular attention to the dark colored infrared mug/cup sensor lens, which is part of the cup station. If it is not thoroughly cleaned, the sensor will not work properly.

CAUTION

Do not get liquid inside the sensor unit.

Cleaning the infrared mug/cup sensor unit itself is not usually necessary. If it does require cleaning, just wipe it with a damp cloth.



Calibration

1. Remove the plastic cap in the rear of the sensing unit, exposing the potentiometer adjusting screw, as shown in figure B1.
2. Turn the screw clockwise to increase sensitivity of cup detection, or counterclockwise to decrease sensitivity.
3. Calibrate the sensor:

CAUTION

Do not adjust sensitivity too far, or unreliable sensing could result.

- a. Using a piece of **WHITE** poster board or heavy cardboard, make a 5" x 5 5/8" target.

NOTE

IT IS VERY IMPORTANT THAT THIS MATERIAL BE WHITE.

- b. Place the target in the cup station just beyond the cup deflectors (see figure B-2). The target should be standing vertically; not tilted forward or backward.
 - c. With the target in place, turn the adjusting screw **clockwise** very slowly until the indicator just turns ON.
 - d. Turn the adjusting screw **counterclockwise** very slowly until the indicator just turns OFF.
4. Replace the plastic cap.
 5. Insert a mug into the cup station in the vending position and check to see that the red indicator light is ON.

This calibration will be adequate for most cups or mugs. In some cases, a slightly more sensitive setting is needed if the cup or mug is a dark color.



VIEWING REAR OF SENSOR ASSEMBLY

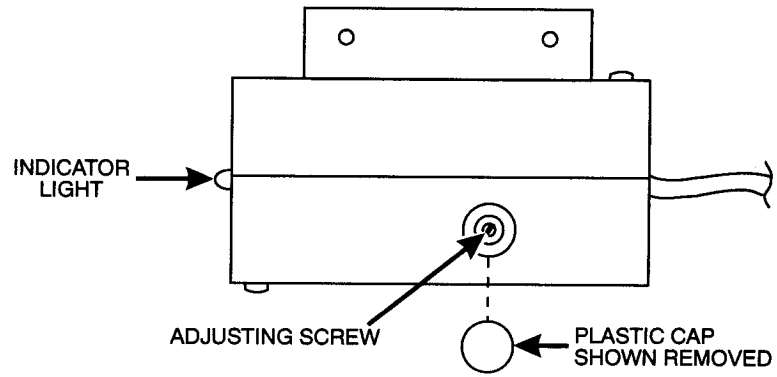

Figure B1

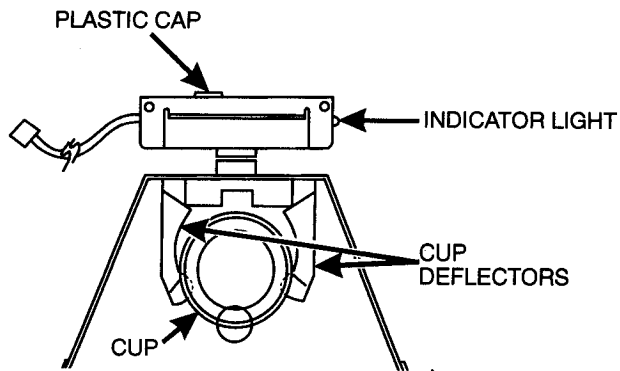

Figure B2





APPENDIX C. DEX/UCS INTERFACE OPERATION

Connect your portable data collection device (PDCD) to the harness hanging inside the monetary door, and operate it per its instructions.

SELECT DATA TRANSFER METHOD:

1. Press . The display shows: *ENTER CODE*. You must enter the four-digit supervisor code within 6 seconds to gain access.

NOTE

A new machine has a factory-set supervisor code of 0000.

When you have entered the right code, you will hear two beeps and see *SUPERVISOR* in the display.

2. Press  until the display shows *DEX.CLR ON* or *DEX.CLR OFF*.

DEX.CLR ON = Data will be cleared after collection is complete.

DEX.CLR OFF = Data will remain in merchandiser memory after collection is complete.

3. Press  to switch between the two options.

4. Press  to exit.

This procedure does not need to be repeated unless you desire to change the data transfer option. However, it might be prudent to check the setting prior to download to ensure unintentional clearing of data.

DOWNLOAD DATA:

1. Press . The display shows *DEX.MODE* while data is being transferred.

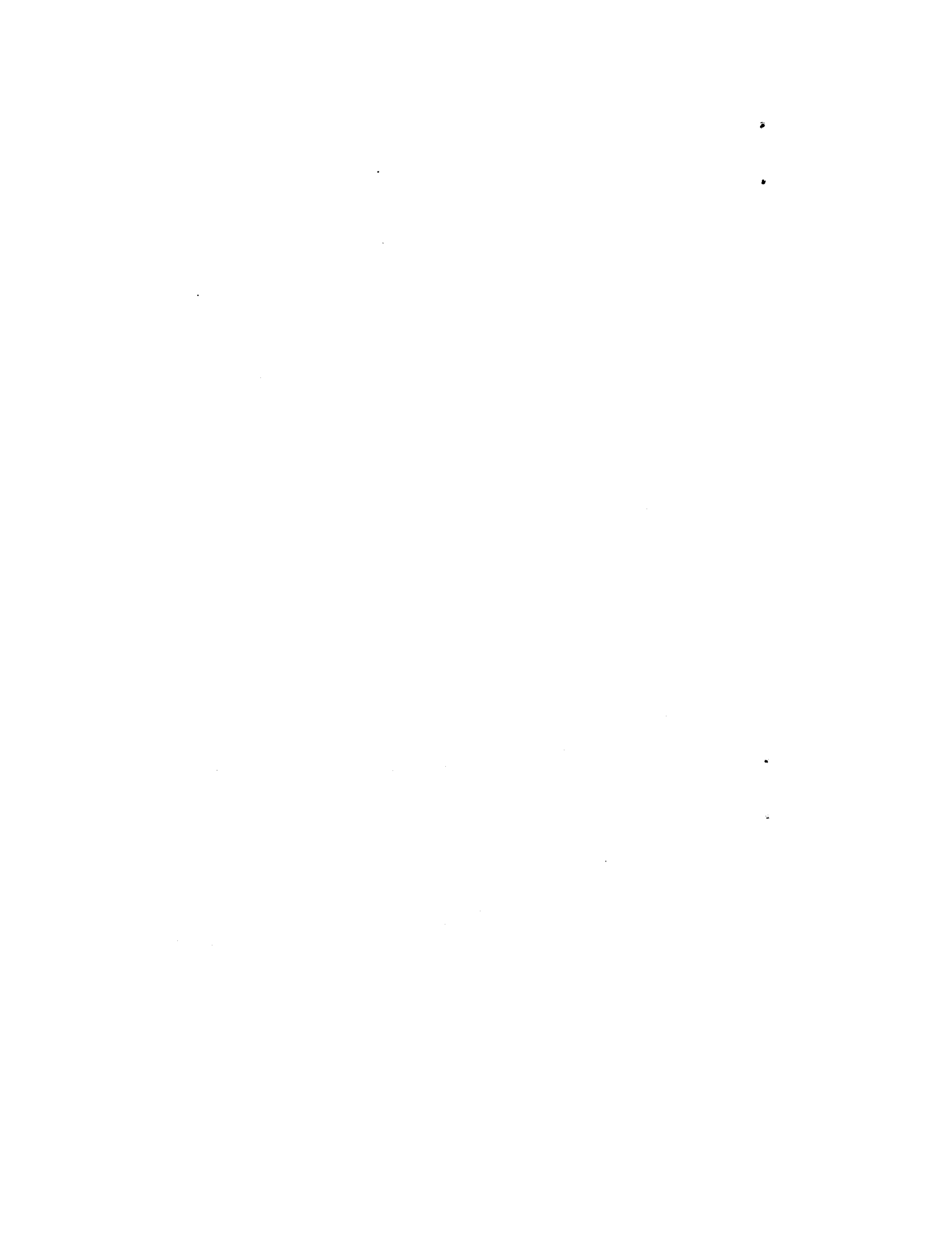



APPENDIX D. MODIFY CANISTER TO VEND 12 OZ. CUPS

Proceed as follows:

1. Remove all cups, then remove the turret center and turret base assembly from the canister.
2. Break off all 8 tabs on the bottom of the turret base as shown.

NOTE

You will no longer be able to vend smaller cups from this canister! To return to vending smaller cups you must replace the modified turret base with an original turret base (part number 6233048) from National Vendors Parts Department.

3. Replace the turret center and turret base in the canister and load cups.
4. Drop a cup. If it drops properly, you are finished with the procedure, if not, continue with step 5.
5. Remove all cups, then remove the canister from the cup mechanism assembly.
6. Remove the funnel, replace the canister, and reload cups.
7. Drop a cup. If it drops properly, you are finished with the procedure, if not, continue with step 8.
8. Order a 5 oz/18oz cup ring (part number 6233120) from National Vendors Parts Department.

APPENDIX D. MODIFY CANISTER TO VEND 12 OZ. CUPS

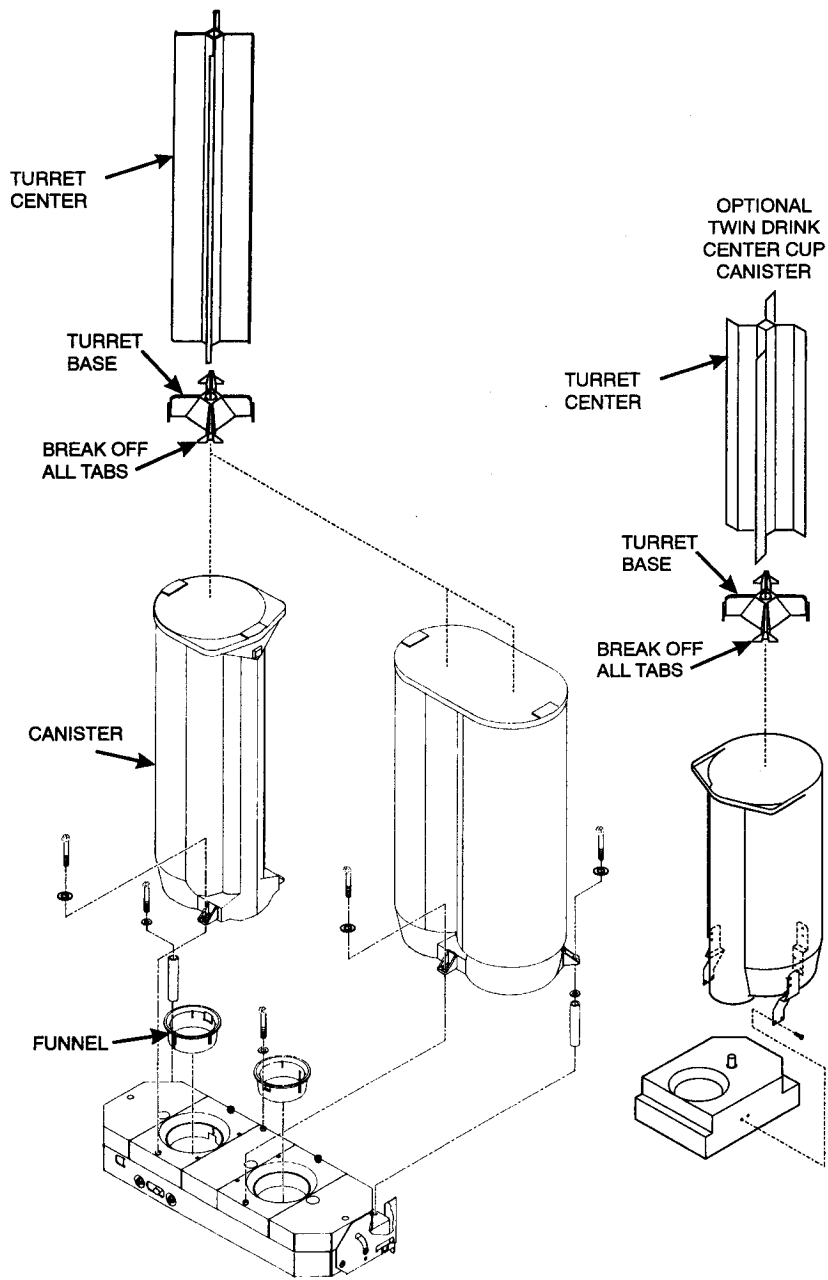



APPENDIX E. CLEAN THE HOT WATER TANK

APPENDIX E. CLEAN THE HOT WATER TANK

Some smell and/or taste problems may occur in new machines. Follow this procedure to clean the hot water tank if you experience problems:

1. If the machine is in service, remove power from the machine.
2. Dissolve 1 tablespoon of common baking soda in a cup of water.

WARNING

The water tank may be HOT. Be careful when working on the tank.

3. Loosen or remove the hot water tank lid and pour the baking soda solution into the tank.
4. Apply power to the machine.
5. If the tank is not full, fill it.
6. Allow the tank to reach its operating temperature.
7. Leave the solution in the tank for **AT LEAST** ½ hour. If possible, leave the solution in the tank for 1 hour.
8. Drain the tank.
9. Refill the tank, then drain again.
10. Refill the tank and put the machine back into service.

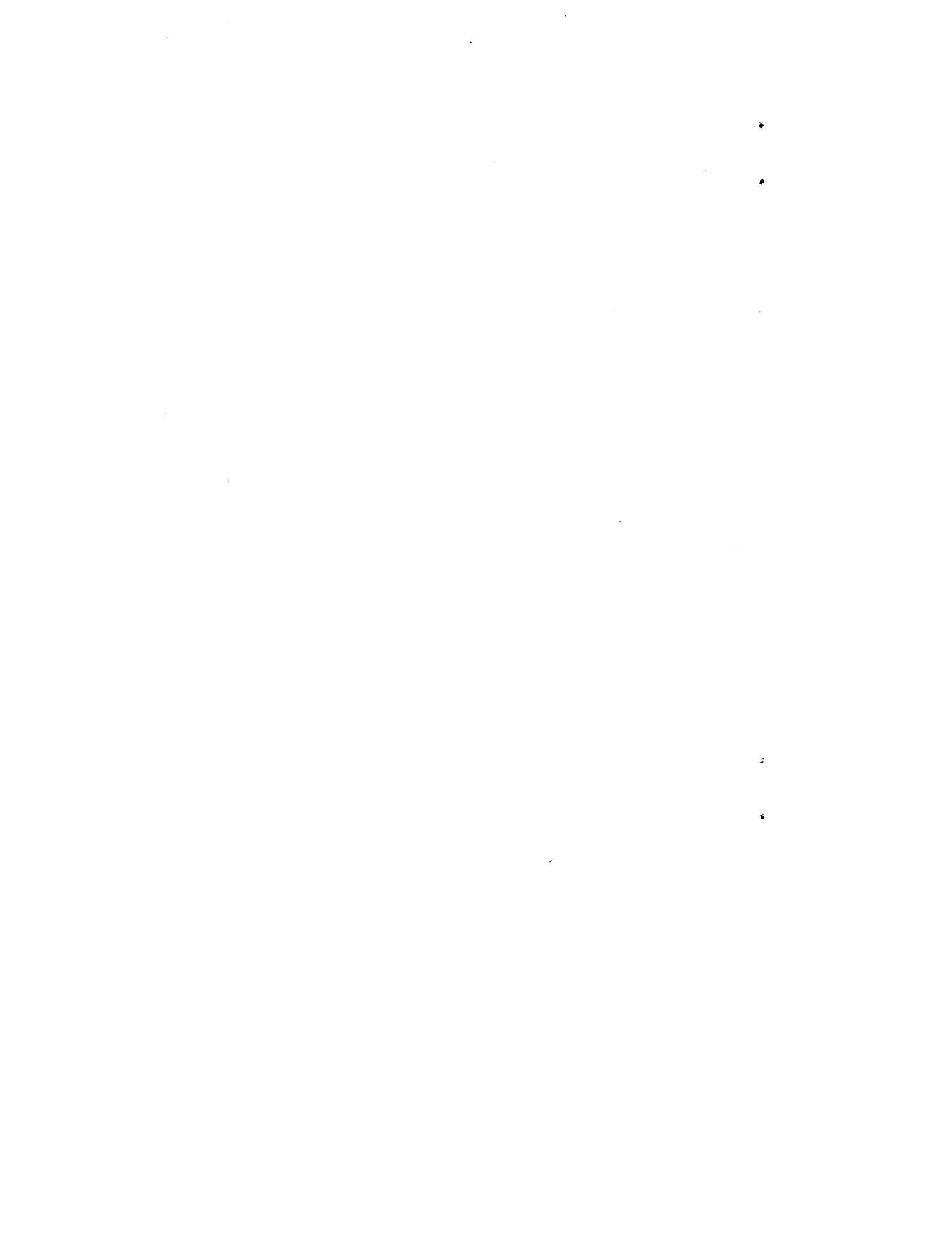



INDEX

A

ACTIVE SELECTIONS, SET UP 54

ADJUSTMENTS 17

 CUP MECHANISM 18

 GRINDER 19

 WATER TANK TEMPERATURE SETPOINT 49

 WATER VALVE 17

AIR COMPRESSOR

 RUNNING TIMES, SET 48

 TEST 81

AUTOMATIC DELIVERY DOOR

 TEST 80

 VIEW OPTION 96

B

BAUD RATE, SET 44

BILL VALIDATOR AND OPTIONS, SELECT 38

BREWER

 RINSE TIME INTERVAL, SET 50

 RINSE 83

 TEST 82

C

CAFFÉ LATTE RECIPE 64

CANISTER INSTALLATION 20

CAPPUCCINO

 RECIPE 60

 SET RATIO OF CHOCOLATE IN 50

CARD READER

 OPTIONS, SELECT 42

 PAID SALES, VIEW 87

CHANGE MACHINE ID NUMBER 95

CHARACTER SET 78

CLEANING 100

CLEARING

 PAID SALES DATA 88

 RESETTABLE DATA 87

COIN

 BOX, VIEW AMOUNT IN 88

 LOCK, INSTALL 11

 MECHANISM, SET UP AND LOAD 11

 MECHANISM AND OPTIONS, SELECT 38

 PAYOUT 84

COLLECTING

 DRY PRODUCT GRAM THROWS 57

 WATER THROWS 66

CONFIGURATION CODE

 SET MACHINE 52

 VIEW 95



| | |
|-----------------------------|----|
| CONTROLS | X |
| CUP | |
| MECHANISM ADJUSTMENT | 18 |
| MECHANISM, TEST | 80 |
| SIZES, SET | 45 |
| CUP ONLY | |
| SET PRICE | 69 |
| SET UP | 54 |
| STATUS, VIEW | 96 |
| CUSTOM MESSAGES, EDIT | 77 |

D

| | |
|---|-----|
| DATA | |
| CLEAR RESETTABLE | 87 |
| CLEARING ACCESS, LOCK OR UNLOCK | 37 |
| SALES, CLEAR PAID | 88 |
| SALES, VIEW BY PRICE | 92 |
| DATE, SET | 71 |
| DAY OF THE WEEK, SET | 71 |
| DEFAULT SETTINGS, DRY PRODUCT WEIGHT AND THROW TIME | 58 |
| DELAY TIME, SET END-OF-VEND | 48 |
| DELIVERY DOOR OPTIONS, SET UP | 55 |
| DEX OPTIONS, SET | 36 |
| DIAGNOSTIC MESSAGES, DISPLAY | 93 |
| DISCOUNT | |
| MUG, SET UP | 44 |
| SALES, VIEW BY TIME INTERVAL | 89 |
| VENDING, TIME-OF-DAY | 72 |
| DISENGAGE THE GRINDER | 20 |
| DISPLAY DIAGNOSTIC MESSAGES | 93 |
| DISPLAYS | 23 |
| LANGUAGE, SELECT | 37 |
| TEST | 79 |
| DOOR ASSEMBLY | |
| EXTERIOR | VI |
| INTERIOR | VII |
| DRY PRODUCT | |
| GRAM THROWS, COLLECTING | 57 |
| THROW TIMES, SET | 46 |
| WEIGHT AND THROW TIME FACTORY DEFAULT SETTINGS | 58 |

E

| | |
|-----------------------------------|----|
| EDIT CUSTOM MESSAGES | 77 |
| EDITING TIME INTERVAL | 73 |
| ELECTRICAL REQUIREMENTS | 1 |
| END OF MESSAGE CHARACTER | 77 |
| END-OF-VEND DELAY TIME, SET | 48 |
| EUROPEAN CAPPUCCINO RECIPE | 65 |



F

| | |
|---------------------------------------|----|
| FILL TANK | 83 |
| FILTER CARTRIDGE, INSTALL WATER | 6 |
| FILTER PAPER, LOAD | 9 |
| FREEVENDS | |
| MESSAGE, SELECT | 76 |
| OPTIONS, SET | 85 |
| SALES, VIEW BY TIME INTERVAL | 89 |
| TIME-OF-DAY | 72 |
| VIEW | 89 |
| FUNCTION KEYS | 24 |

G, H

| | |
|------------------|----|
| GRINDER | |
| ADJUSTMENT | 19 |
| DISENGAGE | 20 |
| TEST | 81 |

I, J

| | |
|--------------------------------------|----|
| ID NUMBER | |
| CHANGE | 95 |
| VIEW | 85 |
| INDICATORS | X |
| INHIBITED VENDING, TIME-OF-DAY | 72 |
| INITIAL SET-UP | 1 |
| INSTALL | |
| CANISTER | 20 |
| COIN BOX LOCK | 11 |

K

| | |
|-----------------------|----|
| KEYPAD, SERVICE | 21 |
| KEYS | |
| FUNCTION | 24 |
| OTHER | 24 |

L

| | |
|------------------------------------|----|
| LANGUAGE, DISPLAY, SELECT | 37 |
| LARGE SIZE DRINKS, SET PRICE | 70 |
| LIGHTENER THROW TIMES, SET | 46 |
| LOAD | |
| COIN MECHANISM | 11 |
| FILTER PAPER | 9 |
| LOCK | |
| COIN BOX, INSTALL | 11 |
| DATA CLEARING ACCESS | 37 |
| MODE OR PAYOUT KEYS | 36 |
| SELECTIONS | 44 |



M

| | |
|--|----|
| MACHINE CONFIGURATION CODE | |
| SET | 52 |
| VIEW | 95 |
| MACHINE ID NUMBER | |
| CHANGE | 95 |
| VIEW | 85 |
| MERCHANDISER, POSITIONING | 3 |
| MESSAGE | |
| CUSTOM | 77 |
| DIAGNOSTIC | 93 |
| FREEVEND | 76 |
| OUT-OF-SERVICE | 75 |
| STANDBY | 75 |
| MINOR MAINTENANCE | 17 |
| MIXING BOWL RINSE TIME AND INTERVAL, SET | 51 |
| MIXING BOWLS, RINSE | 82 |
| MODE KEYS, LOCK OR UNLOCK | 36 |
| MONETARY OPTIONS, SELECT | 40 |
| MUG DISCOUNT, SET UP | 44 |

N

| | |
|---|----|
| NONRESETTABLE SALES AND VEND DATA, VIEW | 86 |
|---|----|

O

| | |
|--------------------------------------|----|
| OPTIONS | |
| CUP ONLY | 54 |
| PRINTER OR DEX | 36 |
| SET FREEVEND | 85 |
| SET UP DELIVERY DOOR | 55 |
| VIEW AUTOMATIC DELIVERY DOOR | 96 |
| WHIP | 55 |
| WHIPPER, SET | 49 |
| OUT-OF-SERVICE MESSAGE, SELECT | 75 |

P, Q

| | |
|---------------------------------------|-----|
| PAID SALES DATA, CLEAR | 88 |
| PAID VENDS, VIEW TOTAL | 87 |
| PARTS, MAJOR | VI |
| PAYOUT KEYS, LOCK OR UNLOCK | 36 |
| PAYOUT COINS | 84 |
| POSITIONING THE MERCHANDISER | 3 |
| POWER REQUIREMENTS | 1 |
| PREVENTIVE MAINTENANCE CLEANING | 100 |
| PRICE SETTING | |
| CUP ONLY | 69 |
| ENTIRE MACHINE | 69 |
| INDIVIDUAL SELECTIONS | 68 |
| LARGE SIZE DRINKS | 70 |
| REGULAR SIZE DRINKS | 70 |



PRINTER
BAUD RATE, SET 44
OPTIONS, SET 36
PROGRAMMING 21

R

RATIO OF CHOCOLATE IN CAPPUCCINO, SET 50
RECIPES
CAFFÉ LATTE 64
CAPPUCCINO 60
EUROPEAN CAPPUCCINO 65
REGULAR SIZE DRINKS, SET PRICE 70
RESETTABLE DATA, CLEAR 87
RINSE
BREWER 83
MIXING BOWLS 82
RINSE TIME INTERVAL, SET
BREWER 50
MIXING BOWL 51
RUNNING TIMES, AIR COMPRESSOR, SET 48

S

SALES DATA
VIEW BY PRICE 92
VIEW NONRESETTABLE 86
SALES
DISCOUNT, VIEW BY TIME INTERVAL 89
FREEVEND, VIEW BY TIME INTERVAL 89
VIEW CARD READER PAID 87
VIEW TOTAL PAID 86
VIEW TOTAL UNPAID 91
SELECT
BILL VALIDATOR AND OPTIONS 38
CARD READER AND OPTIONS 42
COIN MECHANISM AND OPTIONS 38
DISPLAY LANGUAGE 37
FREEVEND MESSAGE 76
MONETARY OPTIONS 40
OUT-OF-SERVICE MESSAGE 75
STANDBY MESSAGE 75
SELECTED WHIPPING OPTION, VIEW 96
SELECTION
CONFIGURATION, VIEW 96
LOCK OR UNLOCK 44
SET PRICES FOR INDIVIDUAL 68
SET UP 54
SWITCH PANEL 21
TEST VEND AND VERIFY CREDIT ADDED 79
SENSORS, TEST 84
SERVICE KEYPAD 21



SETTINGS

- ACTIVE SELECTIONS 54
- AIR COMPRESSOR RUNNING TIMES 48
- BREWER RINSE TIME INTERVAL 50
- COIN MECHANISM 11
- CUP ONLY OPTION 54
- CUP SIZES 45
- DATE 71
- DAY OF THE WEEK 71
- DELIVERY DOOR OPTIONS 55
- DEX OPTIONS 36
- DRY PRODUCT THROW TIMES 46
- END-OF-VEND DELAY TIME 48
- FREEVEND OPTIONS 85
- LIGHTENER THROW TIMES 46
- MACHINE CONFIGURATION CODE 52
- MIXING BOWL RINSE TIME AND INTERVAL 51
- MUG DISCOUNT 44
- PRICE FOR ALL LARGE SIZE DRINKS 70
- PRICE FOR ALL REGULAR SIZE DRINKS 70
- PRICE FOR CUP ONLY 69
- PRICE FOR ENTIRE MACHINE 69
- PRICES FOR INDIVIDUAL SELECTIONS 68
- PRINTER BAUD RATE 44
- PRINTER OPTIONS 36
- RATIO OF CHOCOLATE IN CAPPUCCINO 50
- STEEP TIMES 47
- SUGAR SUBSTITUTE THROW TIMES 47
- SUGAR THROW TIMES 46
- THROWS 56
- TIME 71
- TIME-OF-DAY DISCOUNT VENDING 72
- TIME-OF-DAY FREE VENDING 72
- TIME-OF-DAY INHIBITED VENDING 72
- WATER THROW TIMES 47
- WHIP OPTIONS 55
- WHIPPER OPTIONS 49
- WINNER MODE 43
- YEAR 71
- SOFTWARE VERSION NUMBER, VIEW 95
- SPECIFICATIONS IV
- STANDBY MESSAGE, SELECT 75
- STEEP TIMES, SET 47
- SUGAR SUBSTITUTE THROW TIMES, SET 47
- SUGAR THROW TIMES, SET 46
- SUPERVISOR MODE FUNCTIONS
 - ENTER A FREEVEND CODE 35
 - ENTER A NEW SUPERVISOR CODE 35
 - GAIN ACCESS TO THE SUPERVISOR MODE 35
 - LOCK OR UNLOCK DATA CLEARING ACCESS 37
 - LOCK OR UNLOCK MODE OR PAYOUT KEYS 36
 - SELECT DISPLAY LANGUAGE 37
 - SET PRINTER OR DEX OPTIONS 36
- SWITCHES, TEST 84



T

| | |
|--|----|
| TANK, FILL | 83 |
| TEMPERATURE SETPOINT, WATER TANK, ADJUST | 49 |
| TEST | |
| AIR COMPRESSOR | 81 |
| AUTOMATIC DOOR | 80 |
| BREWER | 82 |
| CUP MECHANISM | 80 |
| DISPLAY | 79 |
| GRINDER(S) | 81 |
| SENSORS | 84 |
| SWITCHES | 84 |
| WHIPPERS | 80 |
| TEST VEND | |
| SELECTIONS | 79 |
| VIEW NUMBER OF | 92 |
| THROW TIMES | |
| DRY PRODUCT | 46 |
| DRY PRODUCT, FACTORY DEFAULT SETTINGS | 58 |
| LIGHTENER | 46 |
| SUGAR | 46 |
| SUGAR SUBSTITUTE | 47 |
| WATER | 47 |
| THROW | |
| DEFAULT TIMES, WATER | 67 |
| DEFAULT VOLUMES, WATER | 67 |
| THROWS | |
| COLLECTING DRY PRODUCT | 57 |
| COLLECTING WATER | 66 |
| SETTING | 56 |
| TIME DATA, VIEW | 90 |
| TIME, SET | 71 |
| TIME INTERVAL EDITING | 73 |
| TIME-OF-DAY | |
| DISCOUNT VENDING | 72 |
| FREE VENDING | 72 |
| INHIBITED VENDING | 72 |
| TOTAL | |
| PAID SALES, VIEW | 86 |
| PAID VENDS, VIEW | 87 |
| UNPAID SALES, VIEW | 91 |
| UNPAID VENDS, VIEW | 92 |

U

| | |
|----------------------------|----|
| UNLOCK | |
| DATA CLEARING ACCESS | 37 |
| MODE OR PAYOUT KEYS | 36 |
| SELECTIONS | 44 |



V

| | |
|---|----|
| VALIDATOR, VIEW AMOUNT IN | 88 |
| VEND DATA, VIEW NONRESETTABLE | 86 |
| VENDS, VIEW TOTAL UNPAID | 92 |
| VERIFY CREDIT ADDED | 79 |
| VIEW | |
| AUTOMATIC DELIVERY DOOR OPTION | 96 |
| CARD READER PAID SALES | 87 |
| COIN BOX AMOUNT | 88 |
| CUP ONLY STATUS | 96 |
| DATA | 86 |
| DISCOUNT SALES BY TIME INTERVAL | 89 |
| FREE VENDS | 89 |
| FREEVEND SALES BY TIME INTERVAL | 89 |
| MACHINE CONFIGURATION CODE | 95 |
| MACHINE ID NUMBER | 85 |
| NONRESETTABLE SALES AND VEND DATA | 86 |
| NUMBER OF TEST VENDS | 92 |
| SALES DATA BY PRICE | 92 |
| SELECTED WHIPPING OPTION | 96 |
| SELECTION CONFIGURATION | 96 |
| SOFTWARE VERSION NUMBER | 95 |
| TIME DATA | 90 |
| TOTAL PAID SALES | 86 |
| TOTAL PAID VENDS | 87 |
| TOTAL UNPAID SALES | 91 |
| TOTAL UNPAID VENDS | 92 |
| VALIDATOR AMOUNT | 88 |
| WATER TANK TEMPERATURE | 95 |
| WINNERS | 90 |

W, X

| | |
|---|----|
| WATER | |
| TANK TEMPERATURE SETPOINT, ADJUST | 49 |
| THROW TIMES, SET | 47 |
| FILTER CARTRIDGE, INSTALL | 6 |
| THROW DEFAULT TIMES AND VOLUMES | 67 |
| TANK TEMPERATURE, VIEW | 95 |
| THROWS, COLLECTING | 66 |
| VALVE ADJUSTMENT | 17 |
| WEIGHT, DRY PRODUCT, FACTORY DEFAULT SETTINGS | 58 |
| WHIP OPTIONS, SET UP | 55 |
| WHIPPER | |
| OPTION, VIEW SELECTED | 96 |
| OPTIONS, SET | 49 |
| TEST | 80 |
| WINNER | |
| MODE, SET UP | 43 |
| VIEW | 90 |

Y, Z

| | |
|-----------------|----|
| YEAR, SET | 71 |
|-----------------|----|

This Merchandiser is warranted for one (1) year against defective parts and workmanship. Any part or parts which are proven to be defective within one (1) year of the date of shipment will be repaired or replaced free of charge when the defective part is returned, with transportation charges prepaid, to the destination designated by the National Vendors Warranty Department.

This warranty applies only to the original purchaser of the Merchandiser and is null and void if the Merchandiser is sold during the period of warranty.

This warranty does not apply to a) electrical components, wiring, or circuits and/or for all mechanical parts or assemblies damaged as a result of operating the Merchandiser at other than the design voltage and frequency specified on the Electrical Rating Tag, or b) in event of vandalism, fire or negligence, or c) incandescent lamps, neon lamps, fluorescent lamps, ballasts, starters or other expendable items or d) when other manufactured components are installed in National Vendors Merchandisers.

National Vendors is not responsible for any cost of service rendered or repairs made by customer or its agents on Merchandiser or parts unless authorization to incur such expense has been given in writing by National Vendors prior to incurring such expense.

THIS WARRANTY IS IN LIEU OF ALL OTHER WARRANTIES EXPRESSED OR IMPLIED, INCLUDING WITHOUT LIMITATION, WARRANTIES OF MERCHANTABILITY OR FITNESS FOR A PARTICULAR PURPOSE. NATIONAL VENDORS SHALL NOT BE RESPONSIBLE FOR CONSEQUENTIAL OR PUNITIVE DAMAGES. National Vendors neither assumes nor authorizes any person to assume for it any obligation or liability in connection with the sale of said equipment or any part thereof.



**National Vendors
A Division of Crane Co
12955 Enterprise Way
Bridgeton, MO 63044**

