

6880025

Café Executive

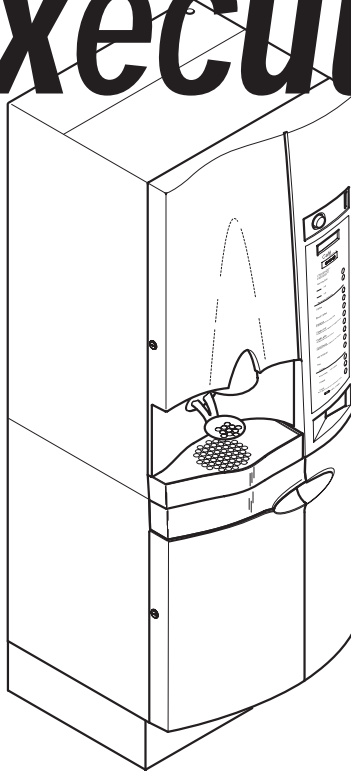

688p0060

Set-Up Guide

CRANE MERCHANDISING SYSTEMS A National Vendors Company
NATIONAL VENDORS

12955 Enterprise Way
Bridgeton, Missouri 63044-1200
(314) 298-3500
www.nationalvendors.com

Copyright© 7-01

6880025

Table of Contents

FEATURES	1
Machine Configuration	1
Microprocessor Controlled Functions	1
Coin Mechanism	1
Options	1
Brewing System	1
SPECIFICATIONS	2
Capacities	2
Selections	2
Dimensions.....	2
Machine	2
Optional Base Cabinet	2
Water Tank.....	2
Weight.....	2
Power Requirements	2
External View Usage Key.....	4
Internal View Usage Key.....	6
SITE REQUIREMENTS	7
Power Supply	7
Water Supply	7
Water Pressure	7
Clearances	8
MACHINE INSTALLATION	9
Counter Top Installation	9
Set And Seal	9
Fasten And Seal	10
Install And Seal	10
Water Line Connections	11
Factory And Field Supplied Parts	11
Flushing Lines	11
Sealing The Unit To The Counter Top	11
Factory And Field Supplied Parts	11
INSTALL WATER FILTER	12
Everpure Brand... ..	13
INSTALL FILTER PAPER	14
Load The Filter Paper Housing... ..	14
Feed Paper Through The Brewer... ..	15
SET UP THE COIN MECHANISM (OPTIONAL)	16
Loading The Coin Mechanism.	16
SET UP THE MENU INSERTS	17
SWITCHES	19

Café Executive Setup

Door Switch	19
Main Power Switch	19
LOAD PRODUCTS	20
Filling Canisters	20
Installing Canisters	20
FILL THE WATER TANK	21
CONTROLS AND DISPLAYS	22
Controls And Displays Usage Key.....	23
PROGRAMMING	24
Initial Steps.....	24
Inside A Function	24
Leaving A Function.....	24
Supervisor Mode	25
Enter Supervisor Mode	25
View Or Change The Supervisor Code	25
View Or Change The Carafe Code	26
Protect Programming Functions.....	27
Configure Your Machine	28
Free Vend	28
Language	28
Water Tank Temperature Display Units	28
Coin Mechanism Setup	28
Card Reader Setup	28
Water Tank Temperature Setpoint	29
Grounds Pail Safety Feature	29
Configuration Codes	30
Key Mapping/drink Recipes	31
Factory Defaults And Drink Sizes	35
Filter Paper Advance Delay Time.....	36
Set Prices For Price Lines	37
Set Up Selections	38
Setting Time And Date	42
Operation	43
Make A Single Drink	43
Making A Carafe	43
Scrolling Messages.....	45
Other Problems And Solutions.....	46
SERVICE KEYPAD	48
TESTING	49
Water Tank Temperature Display	49
Water Tank Fill	49
Pump Test.....	50
Brewer Test (Machines With Brewers Only).....	50
Whipper Test.....	50

Café Executive Setup

Input Switch Tests	51
Keypad Test.....	51
DATA COLLECTION	51
Total Sales	51
Total Vends	51
Vends By Price Line	52
Clear Information	52
MISCELLANEOUS	53
Software Version Number.....	53
Payout.....	54
ROUTINE MAINTENANCE	55
Empty The Liquid Drain Tray.....	55
Empty The Grounds Pail	55
Reset Tank Error	56
Clear Grounds Pail Count	56
Test Brewer Operation	57
Rinse Brewer	57
Rinse Mixing Bowl	57
Change Fuses.....	58
Adjust Water Valves	59
CLEANING AND SANITATION	60
How Do I Sanitize?	60
A Good Place To Start -- Your Sanitation Kit	61
Sanitation Procedures.....	62
Food-contact Parts	62
Non Food-contact Parts	64
Overall Cleaning	64
Preventive Maintenance Cleaning.....	64
Clean The Brewer.....	65
Sanitation Intervals.....	69
Appendix A. Factory Default Times.....	A1

FEATURES

MACHINE CONFIGURATION

- Fresh brew (FB) coffee, FB decaf, blended coffee, espresso, cappuccino, hot chocolate, and hot water.
- A soluble product, such as soup, whitener (with whipper), or International coffee (with whipper).
- 5 oz to 12 oz drinks may be served.
- Choice of small or large drink volume may be served for each selection.
- Consumer's own mug or cup must be used.
- Consumer may use a multi-cup carafe.
- Carafe mode is available for all drink types.

MICROPROCESSOR CONTROLLED FUNCTIONS

- Machine configuration and data retrieval.
- Multiple pricing.
- Drink timing and recipe settings.
- Water temperature setting.
- Diagnostic messages.

COIN MECHANISM

None standard, but your machine can easily be converted to a coin-operated unit.

- 24 VDC, 15 Pin connector "Dumb" mech. (Mars #TRC-6010XV, Coin Acceptors #9302-LF).
- Executive coin mech. interface.
- MDB interface.

OPTIONS

- Electric water pump kit (for installing plumbing to bottled water).
- Choice of Hydrolife or Everpure water filter.
- Insulated 60 oz thermal carafe.
- Matching base cabinet with large capacity waste containers, removable floor liner.

BREWING SYSTEM

- Award winning continuous flow brewing system.
- Brewing with filter paper to maximize the quality of each drink
- Adjustable steep times.
- Cup by cup brewer, ensuring every cup is freshly made.

SPECIFICATIONS

CAPACITIES

- Ground coffee, regular or decaf..... 5 lbs.
- Freeze-dry coffee, regular or decaf..... 2 lbs.
- Hot chocolate 10 lbs.
- Whitener 4 1/2 lbs.

SELECTIONS

- Standard: 8 variable product selections:
2 drink sizes of the following:
Coffee, Decaf Coffee, Blended Coffee, Espresso,
Mochaspreso®, Hot Chocolate, International Coffee, and
Hot Water
- Optional: 8 variable product selections:
2 drink sizes of any of the above plus Coffee with whitener,
Cafe' Mocha, Cappuccino, Caffè' Latte, and others

DIMENSIONS

MACHINE

- Height 34"
- Width 22 1/2"
- Depth..... 22 5/8"

OPTIONAL BASE CABINET

- Height 30" including 6" skirt and levelers
- Width 22 1/2"
- Depth..... 22 5/8"

WATER TANK

- Capacity 2.2 gallons
- Water Valves Up to 5 hot water valves
- Domestic Heating Element 1250 watts @ 115 VAC
- International Heating Element 2000 watts @ 230 VAC

WEIGHT

- Machine 165 lbs.
- Optional Base Cabinet 105 lbs.

POWER REQUIREMENTS

- Domestic and Canada 115 VAC / 60 Hz - 15 Amp Circuit
- International 230 VAC / 50 Hz - 10 Amp Circuit

INDOOR USE ONLY

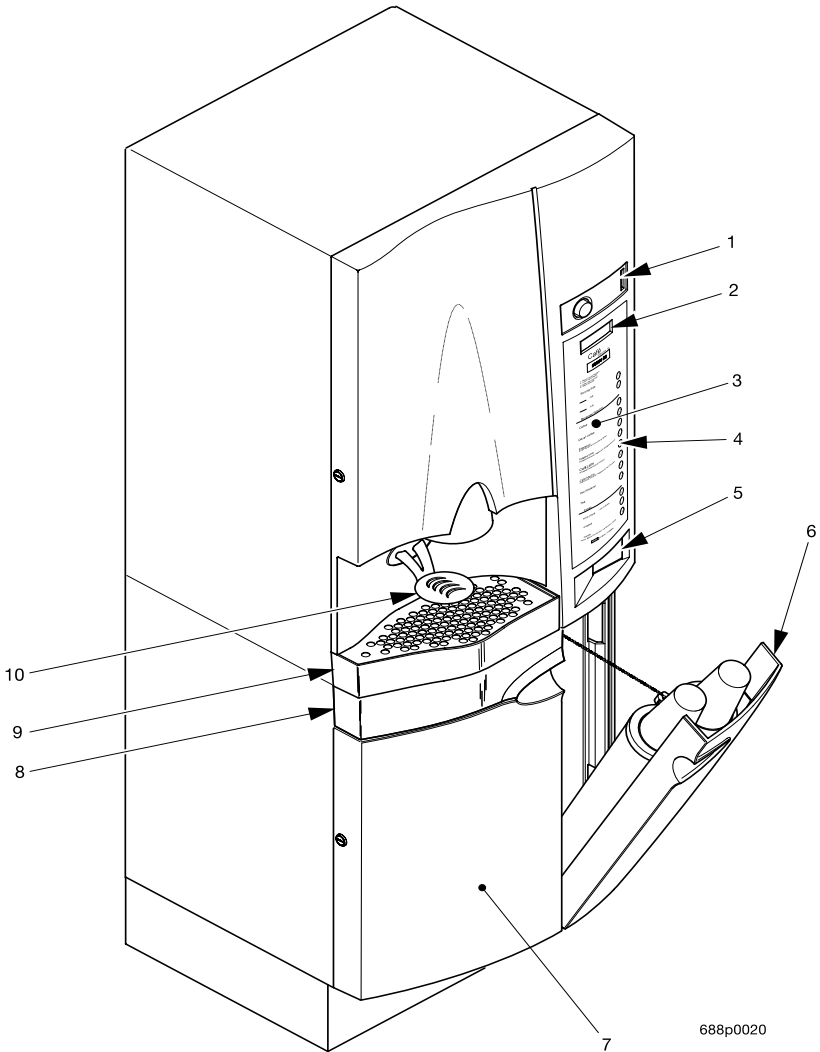

688p0020

EXTERNAL VIEW

Café Executive Setup

EXTERNAL VIEW USAGE KEY

The items on the previous page are identified as follows:

ITEM NUMBER	DEFINITION
1	Coin insert and Coin return button
2	Message display
3	Drink selection menu
4	Selection and programming keypad
5	Coin return cup
6	Pull-out cup dispenser
7	Base cabinet door
8	Pull-out condiment tray
9	Carafe platform and liquid drain tray
10	Cup platform

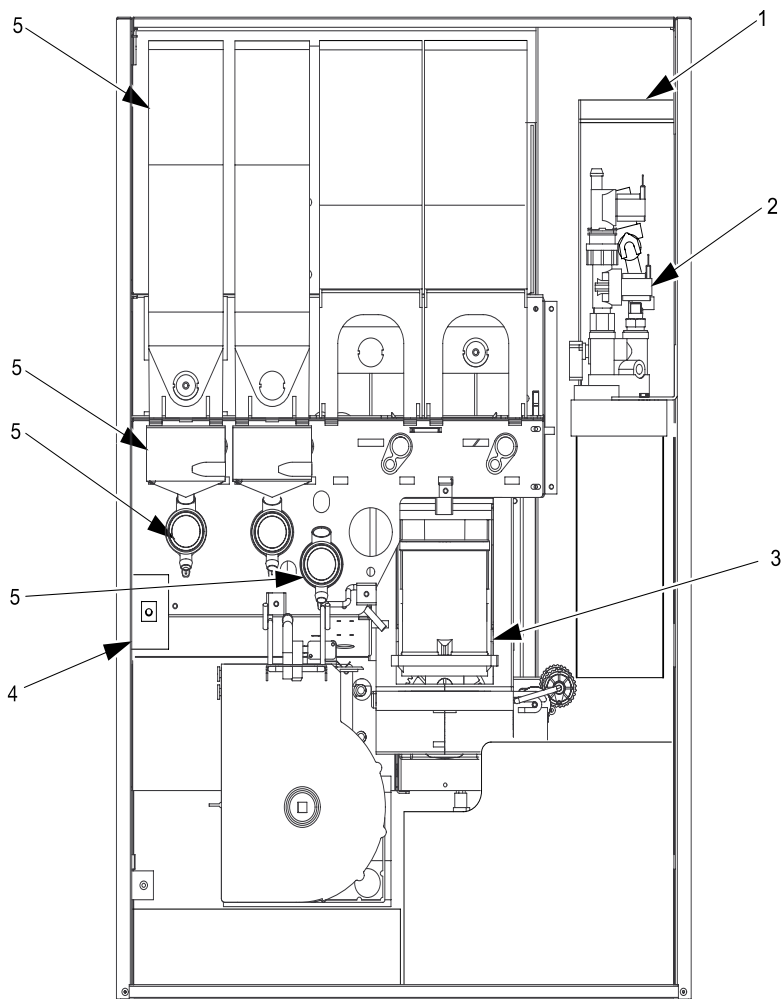

688p0026

INTERNAL VIEW

Café Executive Setup

INTERNAL VIEW USAGE KEY

The items on the previous page are identified as follows:

ITEM NUMBER	DEFINITION
1	Inlet water valves
2	Water filter assembly
3	Brewer
4	Coffee grounds pail
5	Liquid drain tray
6	Filter paper housing
7	Door switch
8	Coffee whipper
9	Ingredient whippers
10	Mixing bowls
11	Soluble product canister
12	Chocolate ingredient canister
13	Decaf canister
14	Coffee canister
15	Hinged lid (opens for easy product loading)
16	Water tank

SITE REQUIREMENTS

POWER SUPPLY

Ensure the machine has its own electrical circuit. NOTE - DOMESTIC UNITS - The internal 4-amp fuse ONLY protects the electronics inside the machine. The unit is provided with a 10 foot power cord and a polarized grounded plug. Use only a polarized grounded receptacle. Always follow national and local codes.

- Domestic and Canada115 VAC / 60 Hz - 15 Amp Circuit
- International 230 VAC / 50 Hz - 10 Amp Circuit

WATER SUPPLY

The best type of water for coffee brewing is normal tap water, filtered to remove sediment, dirt, and chlorine. National Vendors recommends the Hydrolife Brand or the Everpure Brand - Model "OCS" filter products to provide the proper level of filtration. If your location has chemically softened water, do one of the following:

- Install a non-softened water supply line to the machine location.
- Contact your local water filter supplier for information and suggestions.
- Use a bottled water source with the optional electric water pump.

An easily accessible shut off valve up stream of the machine is highly recommended. This will simplify installation of the unit. Always follow national and local codes.

WATER PRESSURE

- Maximum water pressure80 PSI
- Minimum water pressure20 PSI

Café Executive Setup

CLEARANCES

The power cord and water connections are on the back of the unit. Three (3) inches of clearance is recommended at the back of the machine. Each side of the unit should have at least six (6) inches of clearance. This will allow for key access on one side and door swing on the other.

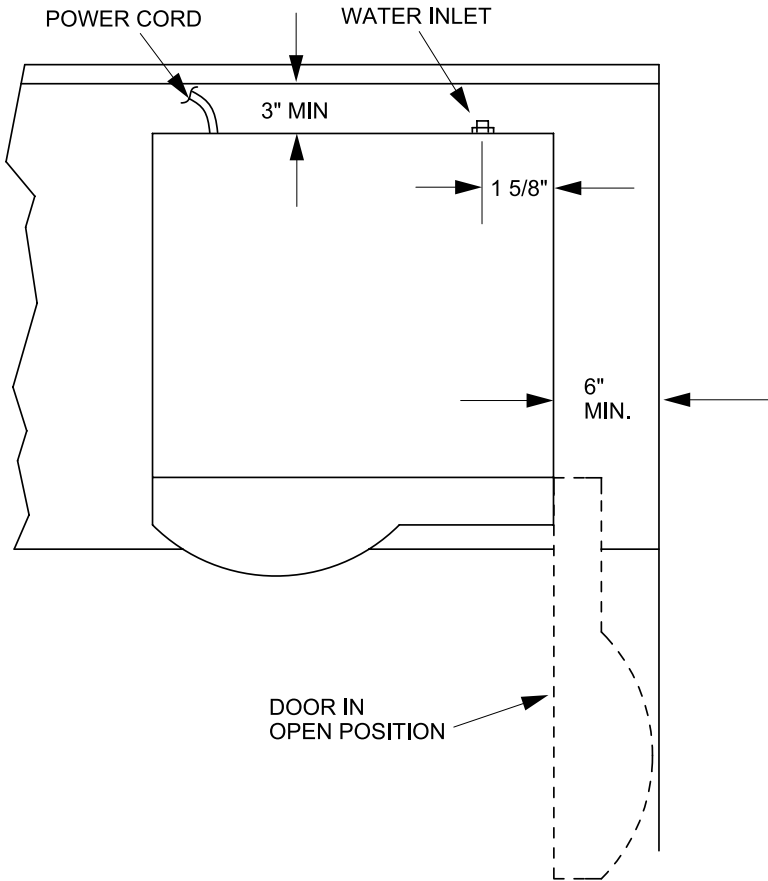

684p0022

MACHINE INSTALLATION

To protect property and provide safety, installation should be completed by properly trained personnel, and in accordance with local and national codes.

This single cup brewer may be installed on a counter top or on the optional factory supplied base. If the base option is used follow the instructions included with it.

COUNTER TOP INSTALLATION

The unit provides three levels of counter top installation.

SET AND SEAL

Locate the unit, make the water connection, plug in the unit, and seal the coffee maker to the counter top with the gasket provided.

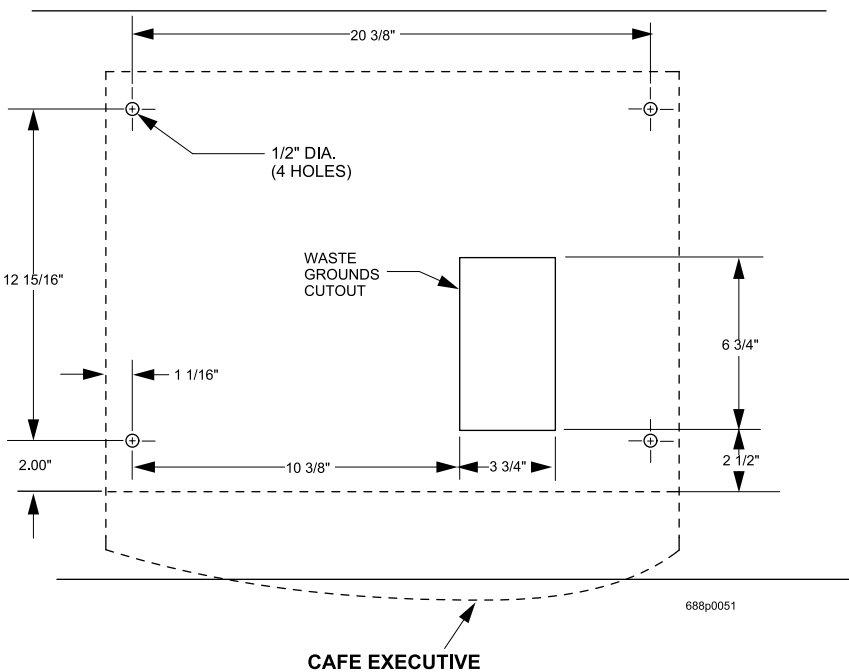

Café Executive Setup

FASTEN AND SEAL

Before beginning this procedure verify both clearance and accessibility from beneath the counter top.

Field Supplied Parts

Four (4) 5/16" thread-cutting screws.

Four (4) 5/16" flat washers.

Correct Screw Length

With the washer installed the remaining thread will equal the counter thickness plus 7/16".

Layout the machine location and mark locations of the four holes. Drill using a 1/2" bit. Secure the unit to the counter top with the thread-cutting screws. Do not overtighten, or the plastic nuts in the machine base may be stripped. (It may be easier to connect the water line before securing the unit to the counter top.)

INSTALL AND SEAL

Before beginning this procedure verify both clearance and accessibility from beneath the counter top. This option allows the use of a large waste grounds pail located under the counter top. Remove the floor liner from the bottom of the unit. Take out the two screws holding the cover plate. Cut a hole corresponding to the opening in the bottom of the unit in the floor liner.

Field Supplied Parts

Four (4) 5/16" thread-cutting screws.

Four (4) 5/16" flat washers.

Correct Screw Length

With the washer installed the remaining thread will equal the counter thickness plus 7/16".

Layout the machine location; then mark locations of the four fastening holes, and a 3 3/4" by 6 3/4" cutout. Drill the holes using a 1/2" bit and make the cutout. Secure the unit to the counter top with the thread-cutting screws. Do not overtighten, or the plastic nuts in the machine base may be stripped. (It may be easier to connect the water line before securing the unit to the counter top.)

WATER LINE CONNECTIONS

FACTORY AND FIELD SUPPLIED PARTS

The water inlet on the unit comes from the factory with a 1/4" female compression fitting. The factory also ship an adapter for use with a 3/8" line, as illustrated below. All other components are field supplied. When code permits the use of plastic tubing, use appropriate inserts at the connections to prevent collapse.

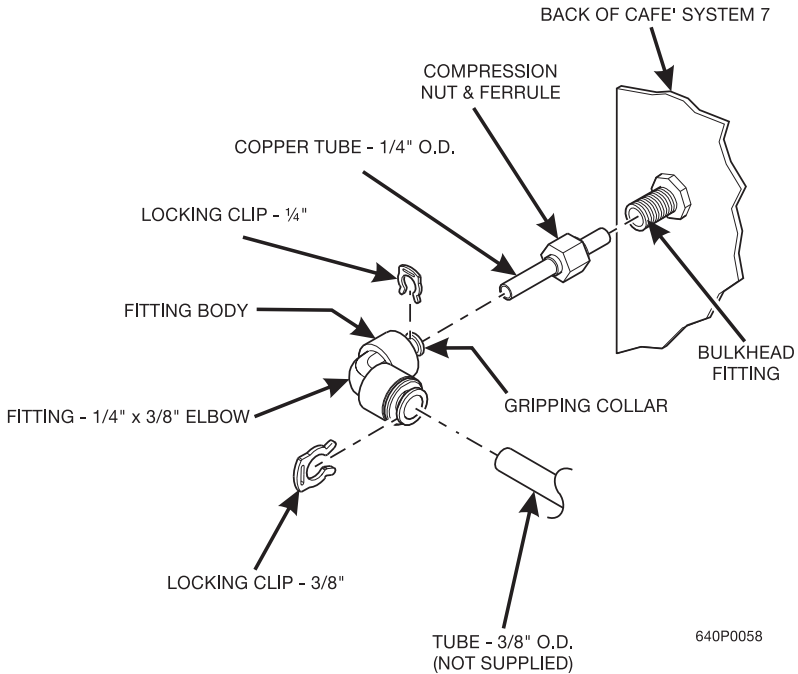

FLUSHING LINES

Water lines should be flushed before connecting to the machine. This will prevent sediment from entering the unit.

SEALING THE UNIT TO THE COUNTER TOP

FACTORY AND FIELD SUPPLIED PARTS

Sealing strip is supplied by the factory. Remove the paper back from a section of the strip and apply to the base. Work a length at a time going completely around the base of the unit. Seal must contact both the unit and the counter top. No other parts are needed for this operation.

INSTALL WATER FILTER

HYDROLIFE BRAND...

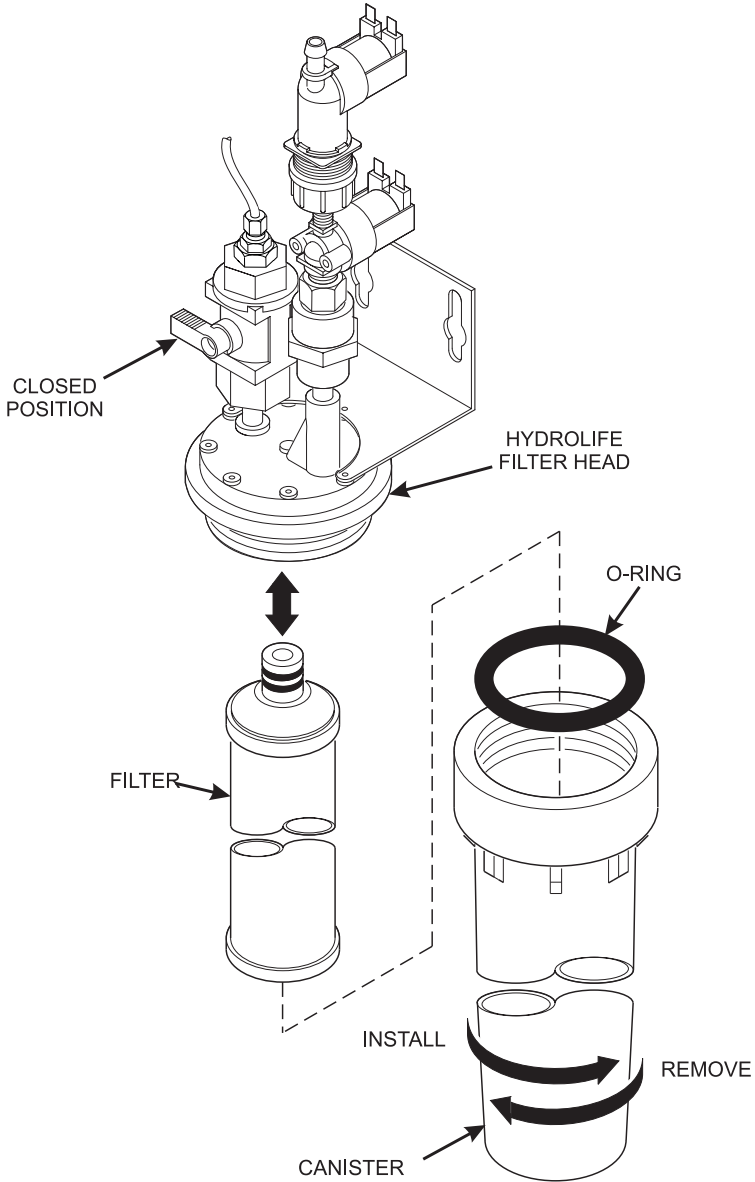

688p0008

Café Executive Setup

EVERPURE BRAND...

TO INSTALL FILTER:

1. ALIGN RAISED RIB ON FILTER CARTRIDGE WITH MATING SLOT IN HEAD ASSEMBLY.
2. FIRMLY INSERT FILTER CARTRIDGE INTO HEAD ASSEMBLY AND ROTATE COUNTER-CLOCKWISE 1/4 TURN TO THE STOP.
3. OPEN THE WATER SHUT-OFF VALVE BY PUSHING THE HANDLE TO THE HORIZONTAL POSITION AS SHOWN BELOW.

TO REMOVE FILTER:

1. CLOSE THE WATER SHUT-OFF VALVE BY LIFTING THE HANDLE TO THE VERTICAL POSITION AS SHOWN BELOW.
2. ROTATE THE FILTER CLOCKWISE AND PULL DOWN AS SHOWN.

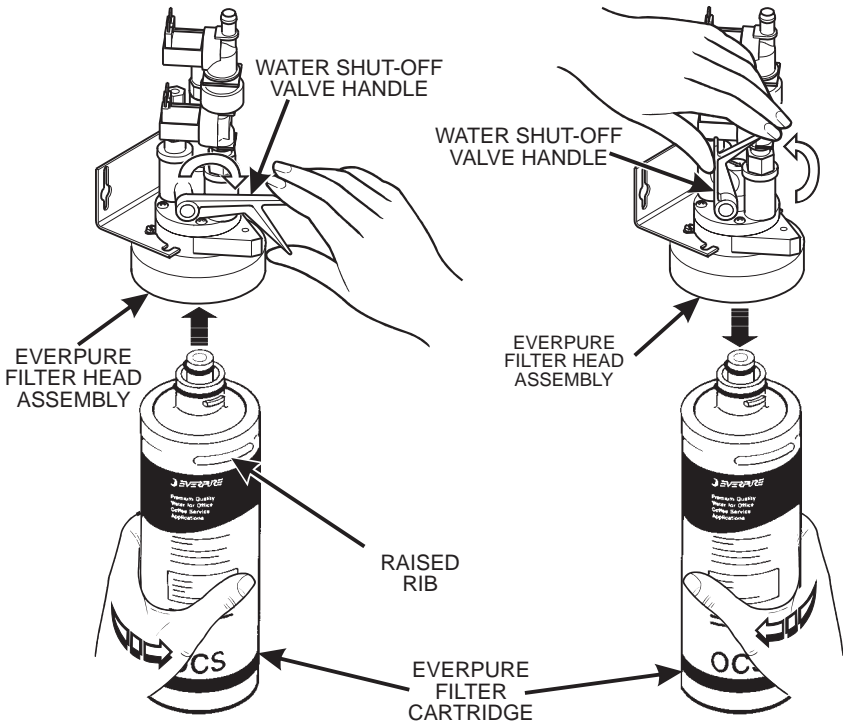

INSTALL FILTER PAPER

LOAD THE FILTER PAPER HOUSING...

1. Turn the fastener $\frac{1}{4}$ turn counterclockwise and remove the filter paper cover.
2. Insert filter paper in the filter paper housing as shown.
3. Feed the paper out of the housing as shown by the arrows molded into the back wall of the filter paper housing.

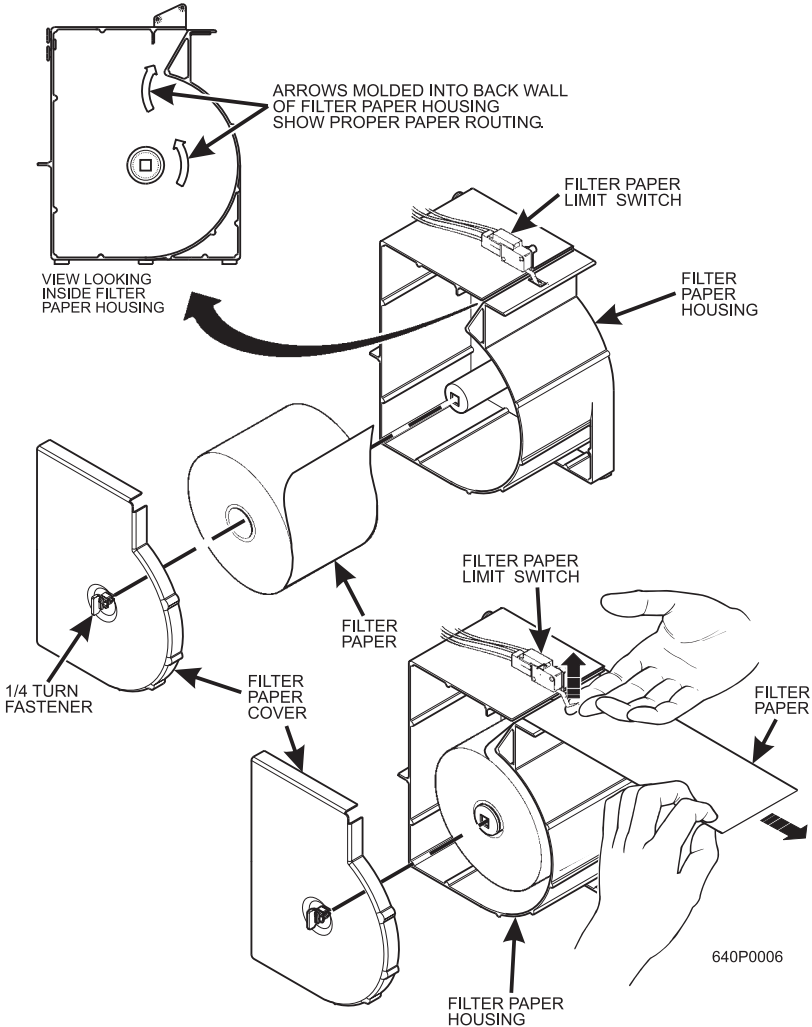

4. Lift up the limit switch and feed the paper past it as shown. Release the limit switch.
5. Replace the cover.

FEED PAPER THROUGH THE BREWER...

1. Hold the idler roller axle up out of the way as shown.
2. Route the paper under the brewer cylinder and the idler rollers.
3. Release the idler roller axle, capturing the filter paper.
4. Route the paper into the grounds bucket. For machines with base cabinets: Feed filter paper through the upper bucket into the lower grounds bucket.

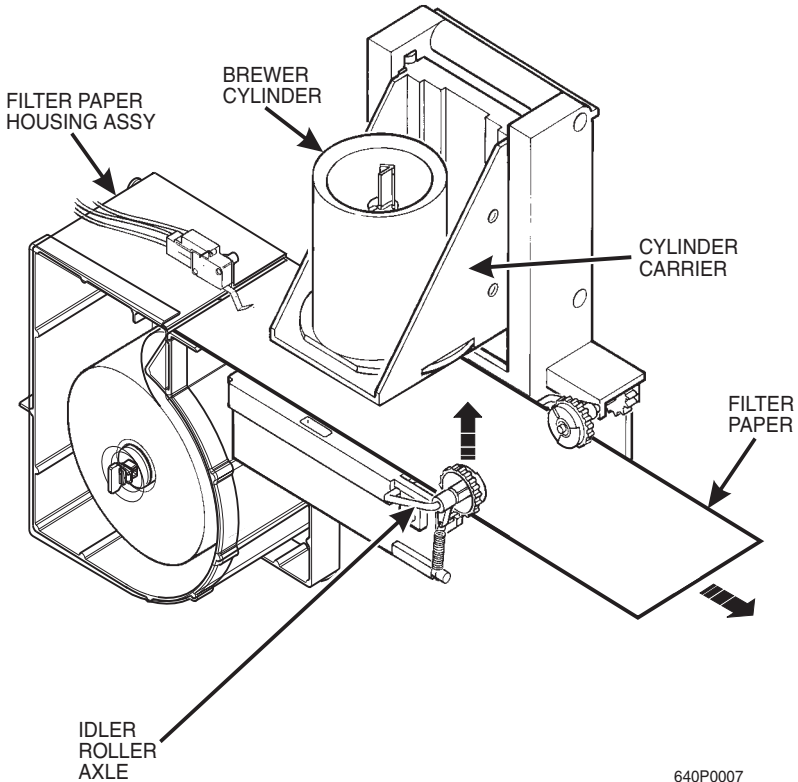

640P0007

SET UP THE COIN MECHANISM (OPTIONAL)

NOTE

Only the following coin mechanisms will function with your machine, and your machine must be configured for the specific type of coin mechanism you are using:

COINCO 9302-GX MDB
COINCO 9302-LF
COINCO USD-G701 MDB
CONLUX USLZ-001 MDB
MARS TRC6010-XV
MARS TRC6512 MDB
MARS VN4510 MDB

LOADING THE COIN MECHANISM.

1. Open the cabinet door.
2. Insert coins into their respective tubes until each tube has been filled.
3. Inspect the tubes for shingled coins and correct if necessary.

SET UP THE MENU INSERTS

Two sets of menu inserts are included with your machine. One set is used in machines where two different drink sizes are available; the other is used when only one drink size is offered..

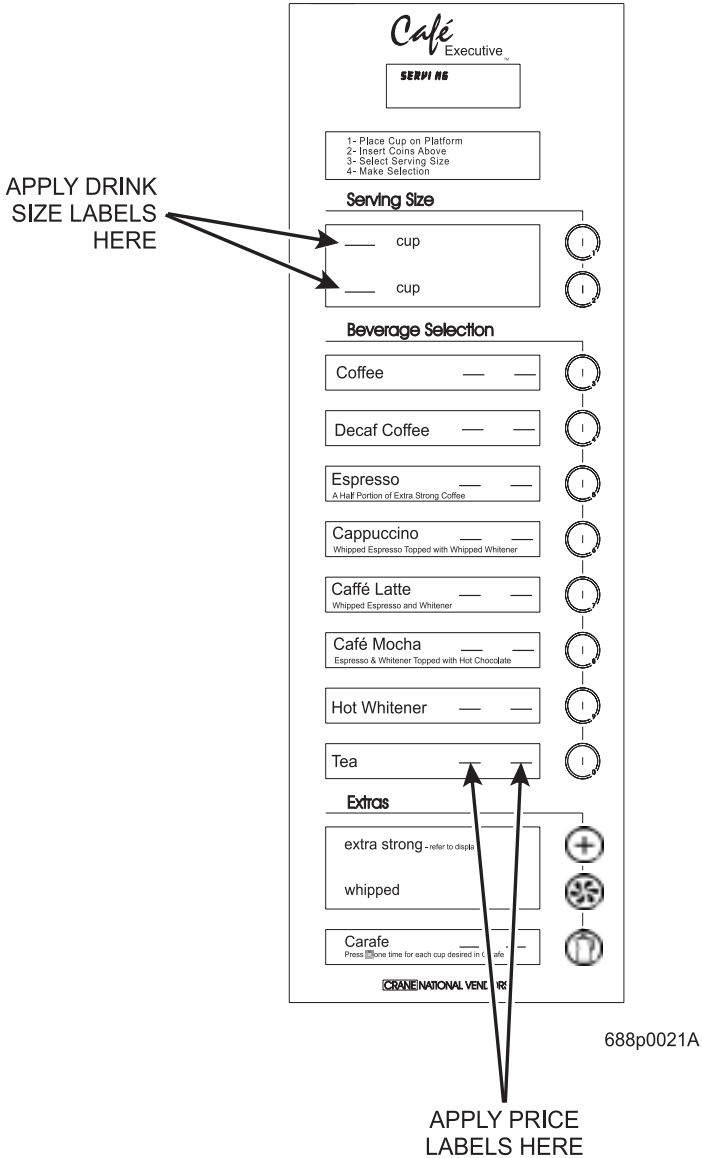

688p0021A

Café Executive Setup

This diagram shows you where each of the menu inserts are used. Blank inserts are provided in the event that all selections are not sold. Refer to "Key Mapping/ Drink Sizes" to verify the order in which these inserts will appear on the menu.

NOTE: Shown as a two cup-size machine.

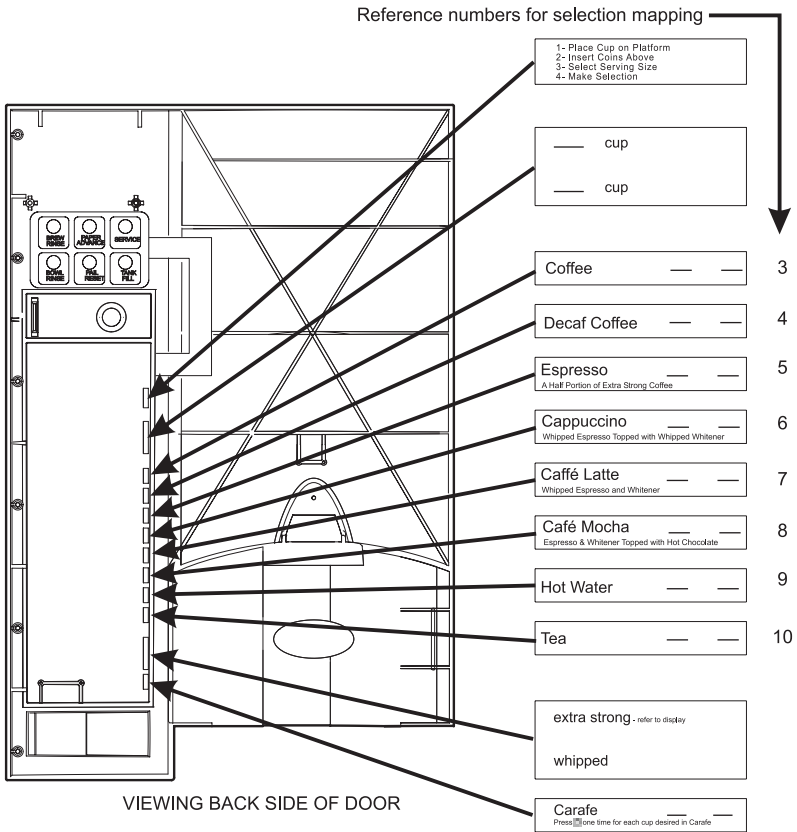

688p0035

SWITCHES

DOOR SWITCH

The door switch has two positions:

- DOOR OPEN Access to programming modes is provided when the door is open.
- DOOR CLOSED Machine returns to the vending mode.

MAIN POWER SWITCH

The main power switch turns off the machine. The main power switch should be turned off when servicing any AC line voltage component.

WHEN SERVICING ANY COMPONENTS WITHIN THE POWER PANEL ASSEMBLY, ALWAYS UNPLUG THE MACHINE FROM THE WALL RECEPTACLE

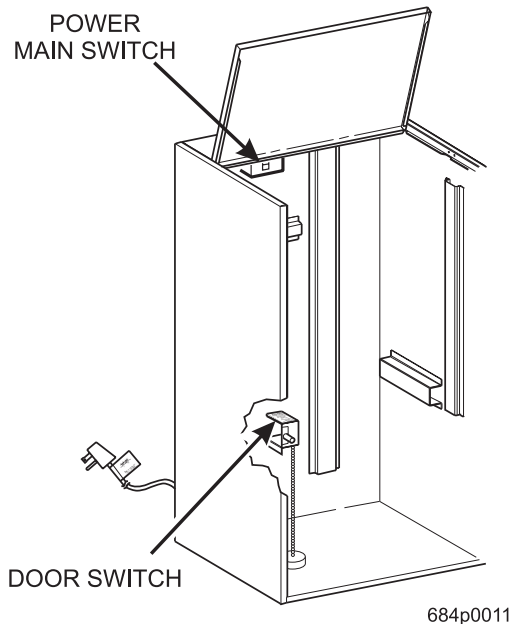

LOAD PRODUCTS

FILLING CANISTERS

1. Flip open the machine lid to gain access to the product canisters.
2. Open each canister lid and carefully pour product into the canister.
3. Close or replace each canister lid after filling.

INSTALLING CANISTERS



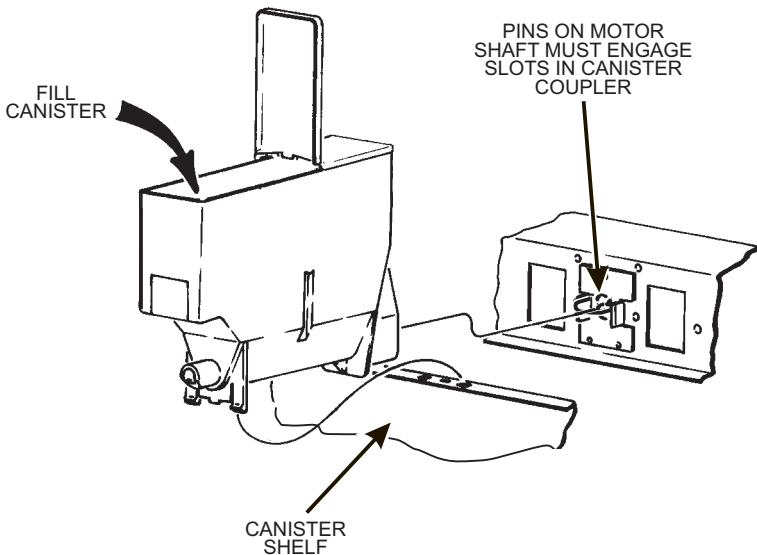

1. Place the canister in position as shown.
2. Engage the pins on the motor shaft with the slots in the canister coupler.
3. Fit tabs on the front canister feet into the slots on the canister shelf.
4. To ensure canister is correctly engaged with the rear mounting bracket, gently push down on the front edge of the canister lid.
5. Replace stainless steel product chutes.



640P0064

FILL THE WATER TANK

For safety purposes, the water inlet valve is not allowed to operate with the tank water level in the low condition for more than one minute. After that, **TANK ERR** is shown in the display if the tank is not filled to its proper level. To clear that error, or to initially fill the water tank (which takes more than 1 minute), proceed as follows:

- a. Ensure the machine is connected to its power source and the switch is ON. Press **TANK FILL** on the service keypad, or press , then . The display shows the water tank temperature.
- b. Press . The display shows: *TANK.FILL*.
- c. Press , then . The display shows: *FILLING*. This clears any tank error and starts filling the tank, if necessary. When the tank is full, the display returns to *TANK.FILL*.

IMPORTANT

Closing the door or otherwise actuating the door switch terminates programming and returns the machine to the vending mode, ending the **TANK FILLING** procedure. In addition, leaving this function by pressing  twice will stop the tank from filling.

- d. If it is taking longer than 6 minutes to fill the tank **AND THERE ARE NO LEAKS**, you may see *TANKERR* in the diagnostic list again. Just repeat steps a - c after making sure there are no other problems, such as a restriction in the water inlet line or a clogged water filter.
- NOTE

The heater will not function until the tank is full. The normal heat up time to reach operating temperature is 45 minutes.

CONTROLS AND DISPLAYS

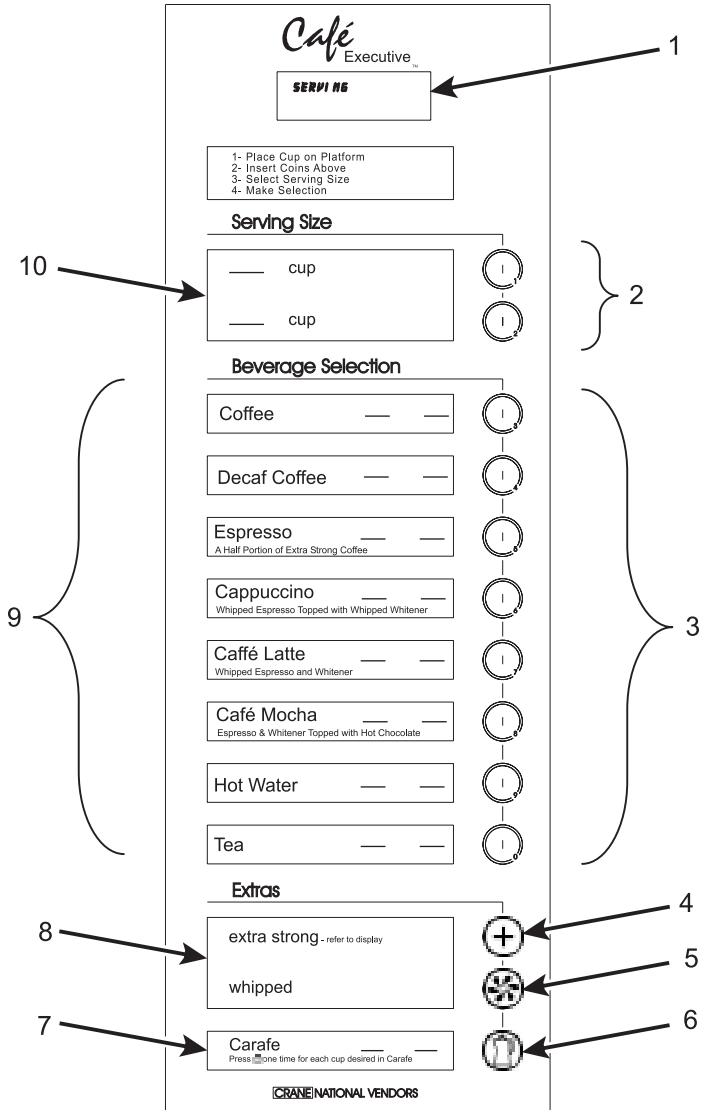

688p0021

Café Executive Setup

CONTROLS AND DISPLAYS USAGE KEY



The items on the previous page are identified as follows:

ITEM NUMBER	DEFINITION
1	Display
2	Drink size selection keys
3	Drink selection keys
4	“Extra strong” selection keys
5	“Whipped drink” selection keys
6	Carafe selection keys
7	Carafe instruction insert
8	“Extras” selection insert
9	Menu inserts
10	Instruction insert



PROGRAMMING

Programming your machine is straightforward and easy to do. Before you get started, take some time to look over these steps.

INITIAL STEPS



1. Open the door.
2. You generally enter a function by pressing , followed by a number key. For example, to enter the *SERVICE* mode you press , then .

INSIDE A FUNCTION

Pressing  moves you forward through all the different programming screens. There is no way to move backwards, so if you have to go back to a previous screen, just press  until that screen shows up again. If you can choose between two or more options in a function, pressing  switches between the options.

LEAVING A FUNCTION



There are two ways to leave a function:

1. Press  twice, or press and release the door switch. This returns you to the standby message.
2. Press  and the number key for another function to go directly there.

SUPERVISOR MODE

Your machine is equipped with a special "Supervisor" mode. A supervisor is allowed access to all programming functions without needing a carafe key. In addition, the supervisor can prevent anyone without the supervisor code from accessing any or all programming functions.

ENTER SUPERVISOR MODE





1. Make sure the door is open and the machine is in the "ready" mode (not already in a programming function).
2. Press  and . The display shows CODE - - -.

NOTE

All machines have a factory default supervisor code of 000.

3. Enter your 3-digit code. You have 6 seconds to enter your supervisor code before the screen goes back to the previous display. If you enter the wrong code, the previous display is shown. If you successfully enter the code, the display shows SUPERVISOR one time. You can now access all programming functions.
4. To leave Supervisor mode, shut the door.





VIEW OR CHANGE THE SUPERVISOR CODE

1. Enter the SUPERVISOR mode as instructed above.
2. Enter the CONFIGURATION mode by pressing  and .
3. Press  to advance through the selections until the display shows CODE XXX. (XXX is the current Supervisor code number.)
4. Use the number keys to enter a new code number. Note that your new number is followed by a decimal point. This decimal point will remain in the display until you have "locked in" your new code. This helps to prevent mistakes.
5. Press  and  to lock in the new code number. The decimal is now gone from the display. If you don't lock in your new code number, the old number is still active.

Café Executive Setup

VIEW OR CHANGE THE CARAFE CODE



A carafe code means that a code must be entered before a carafe can be dispensed.









1. Enter the **SUPERVISOR** mode as instructed above.
2. Enter the **CONFIGURATION** mode by pressing  and .
3. Press  to advance through the selections until the display shows **CARAFE XXX**. (XXX is the current carafe code number.)
4. Use the number keys to enter a new code number. Note that your new number is followed by a decimal point. This decimal point will remain in the display until you have "locked in" your new code. This helps to prevent mistakes.
5. Press  and  to lock in the new code number. The decimal is now gone from the display. If you don't lock in your new code number, the old number is still active.

NOTE



Entering a code of 000 will disable the carafe code protection and allows any user to dispense carafes.

PROTECT PROGRAMMING FUNCTIONS

1. Enter the **SUPERVISOR** mode as instructed above.
2. Enter the **CONFIGURATION** mode by pressing  and .
3. Press  to advance through the selections until the display shows **PROTECT**. (This display only lasts for a short time, then it is replaced by -----). The dashes are placeholders for the nine programming functions, and will be replaced by numbers representing which functions you have protected (prevented others from using).
4. Press any or all of the following keys to protect its corresponding function from unauthorized access:



	OR		REG. & LG. DRINKS = SETUP		= NOT USED
	= VIEW DATA COUNTERS		= PAY COINS		= TEST MACHINE
	= ASSIGN PRICES		= VIEW ERRORS		
	= SET OPTIONS				

SPECIAL NOTES:



- a. Functions 1 and 2 (selection setup) both activate the 1 in the display.
- b. Function 3 (data recall) has an additional choice. Pressing  once causes a plus sign to be displayed. This means that others can still view sales data, but they cannot clear it. Pressing  a second time displays a **3**, and prevents all access.

5. The display shows which functions are protected. For example, 1 + 4 5 - 7 - . means that only the supervisor can set up drinks, clear data, change price lines, set options, and pay out coins.

Café Executive Setup

6. Observe that there is a decimal point trailing the above example. This means that you have not "locked in" these items as yet. Press  and  to lock in the protected functions. The decimal is now gone from the display. If you don't lock in these numbers, the old numbers (if any) are still active.

CONFIGURE YOUR MACHINE

1. Press  and  to enter the **CONFIGURATION** mode. Press  to advance through the following selections:

FREE VEND

1. Press  to switch between *FREE ALL* (all selections are free), *FREEOFF* (no selections are free).

LANGUAGE

1. You may change the customer display language if you wish. Press  until your language is displayed: *ENGLISH*, *DEUTSCH*, *FRANCAIS*, or *ESPAÑOL*.

WATER TANK TEMPERATURE DISPLAY UNITS

1. You can choose your water tank temperature to be displayed in degrees Fahrenheit or Celsius. Press  to switch between *UNITS °F* and *UNITS °C*.

COIN MECHANISM SETUP

1. Press  to switch between *NO MECH*, *MOB MECH*, *DUMB MECH*, or *EXEC MECH*.

CARD READER SETUP

1. Press  to switch between *NO CARD*, *MOB CARD*, or *DUMB CARD*.

WATER TANK TEMPERATURE SETPOINT

1. Use the number keys to change the water tank temperature setpoint. Vending will be inhibited if the tank temperature falls more than 20° below the setpoint. This feature preserves the quality of the drink served to the customer.

SETPOINT

The water tank heater tries to maintain a constant temperature, much like a household thermostat. This temperature is called the setpoint. The actual water temperature fluctuates from time to time, because cold water will enter the tank after a vend and time is needed to heat that water up to the setpoint.

The valid range of temperature setpoints is from 149° F(65° C) to 205° F (96° C).

GROUNDS PAIL SAFETY FEATURE

Each cup of brewed coffee produces waste grounds and filter paper which are automatically dumped into a grounds pail. To prevent the pail from overflowing, the machine's computer counts the number of cups brewed and shuts the brewer function off after 80 cups have been brewed. This factory set value of 80 can be changed to any number between 5 and 995 in increments of 5. A setting of 0 will disable this function, allowing an overflow problem. The higher settings are used with a base cabinet.

NOTE



Entering a zero (0) will disable this function, causing a potential overflow problem.

Café Executive Setup

CONFIGURATION CODES

The configuration codes (*CONF XYZ*) must agree with the physical configuration of your machine. Set the X, Y, and Z codes according to the following tables:

Whipper Configuration

ENTER FOR (X)	DEFINITION
1	Whip drinks only when  is pressed
2	Whip drinks unless  is pressed

NOTE

If you program the whipper option ON for a drink, the button has no effect (see SET UP SELECTIONS).

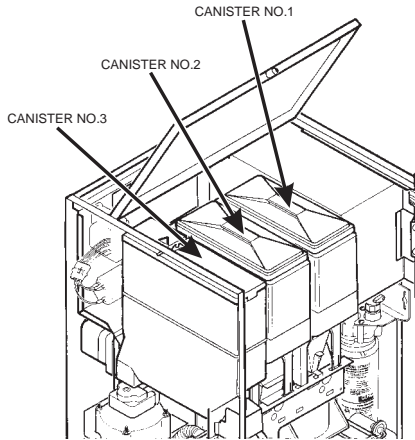

Whitener Configuration

ENTER FOR (Y)	DEFINITION
1	No whitener (whitener not available)
2	Whitener is used (whitener is available)

Café Executive Setup

Machine Configuration

ENTER FOR (Z)	DEFINITION
1	All Freeze Dry
2	Single Fresh Brew - Made from product in canister #1
3	INVALID - NOT USED
4	Dual Fresh Brew - Made from products in canisters #1 and #2

Press , then  to lock in this setting.

KEY MAPPING/DRINK RECIPES

The display will show *KEYMAP* for a moment, then the display shows:

XXXXXXXX

The eight "X"s are occupying positions representing the buttons numbered 3 through 0:

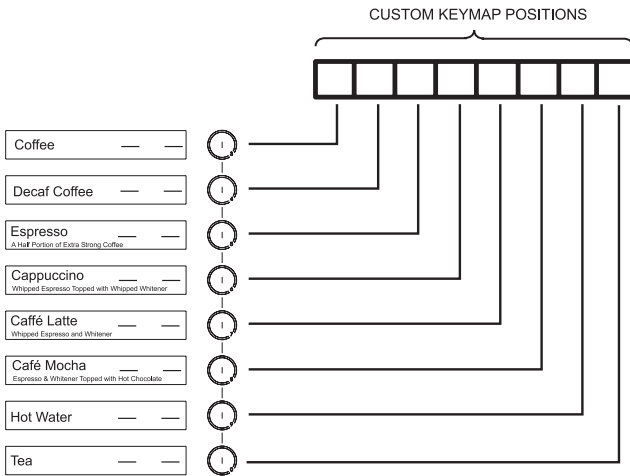



688p0033

Notice that the eight characters are shown as boxes. This is because each selection button is represented by a position in the display, but any number between 0 and 9 or any letter between A and L can be in that position. All this allows you to take advantage of a very flexible custom menu setup.

The keymap is used to choose which recipes will be assigned to which keys. To assign a recipe to a key, press the intended key repeatedly until the number/letter

Café Executive Setup

of the desired recipe appears. Repeat this for all keys. When the keymap is satisfactory, save the new map by pressing  and .

Note that there are more possible recipes than keys. Because of this and other factors, it is important to reload the timers after altering the keymap, even if only the order of recipes was changed. This may be done manually or by using the default load screen following the keymap screen.

If any recipes are not possible with the current configuration, that recipe letter will be skipped on the keymap screen.

Each number between 0 and 9 or letter between A and O represents a selection. All current recipes are listed below, along with any restrictions which may accompany them. Note that recipes 0 - 9 can be made with all machines, but recipes A - K are only available with machines configured for whitener.

Recipes





CODE	DEFINITION
0	No selection is assigned to this button.
1	Coffee (or Tea) made from canister #1
2	Decaf coffee made from canister # 2
3	Blend - A percentage only mix of coffee and decaf coffee. Both coffee and decaf must be configured for this to work.
4	Espresso #1 - A short throw from canister #1. Timers are fully programmable.
5	Espresso #2 - A short throw from canister #2. Timers are fully programmable.
6	Mochaspreso® #1 - A percentage only mix of coffee and hot chocolate. Both coffee and chocolate must be configured for this to work.
7	Mochaspreso® #2 - A percentage only mix of decaf coffee and hot chocolate. Both decaf coffee and chocolate must be configured for this to work. This drink is not possible if the machine is configured for whitener.
8	Hot chocolate made from canister #3.
9	Water - Hot water only
A	Coffee with whitener - Made from canister #1 plus whitener.
B	Reserved for future recipes.
C	Reserved for future recipes.
D	Espresso with whitener #1 - A short throw from canister #1 plus whitener. Timers are fully programmable.
E	Reserved for future recipes.

Café Executive Setup

Recipes (Continued)

CODE	DEFINITION
F	Café Mocha - Made from canisters #1 and #3 (coffee and hot chocolate) plus whitener. Includes two percentages for setting approximate times for whitener and hot chocolate. Timers are fully programmable.
G	Cappuccino #1 - A mix of coffee and heavy whitener. Includes a percentage for setting approximate times. All timers are fully programmable.
H	Reserved for future recipes.
I	Caffé Latte #1 - Same as Cappuccino #1 except whipped and layered differently.
J	Reserved for future recipes.
K	Hot whitener - Made from whitener and hot water.
L	A mix of canisters 1 and 4
M	A mix of canisters 2 and 4
N	A mix of canisters 3 and 4
O	Soluble product from canister 4

You have the option of programming any button to vend any one of these selections! For example, you're not vending Mochaspresso® or Hot Chocolate, and you don't want two empty spaces between Espresso and Hot Water. Do this:

- Set up your menu inserts as shown previously, with Hot Water opposite button **7**, and the two blank inserts opposite buttons **8** and **9**.
- Go to the KEY MAP display as explained previously.
- Press the number corresponding to the selection you are vending from button **3**. In this case, you are vending coffee (the product in the right canister), number **1**.
- Press the number corresponding to the selection you are vending from button **4**. In this case, you are vending decaf (the product in the middle canister), number **2**.
- Repeat this procedure for buttons **5** and **6**.
- Press the number corresponding to the selection you are vending from button **7**. In this case, you are vending hot water, number **9**.
- Since you are not vending anything from buttons **8** and **9**, press  twice. The display should now look like this: .1234900.
- Press , then  to lock in this setting.
- Press  twice to leave the CONFIGURATION mode at any time.

Café Executive Setup

FOR EXAMPLE...

Here are two examples based on the settings shown previously. The menu insert configuration on the left represents a fully featured machine with Mochaspreso® and Hot Chocolate. The menu inserts on the right show a machine which does not vend Hot Chocolate or Mochaspreso®, and utilizes the blank inserts. More complicated arrangements can be built by mixing the order of the menu inserts and the key mapping. The choice is up to you

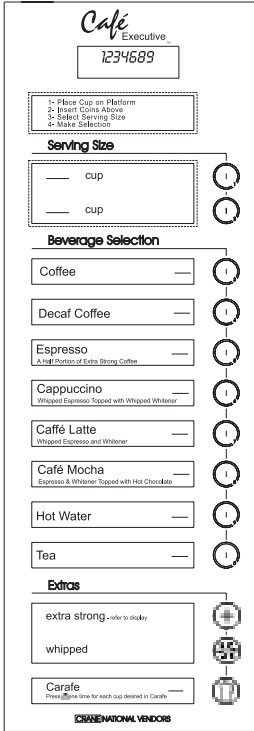

SINGLE SELECTION

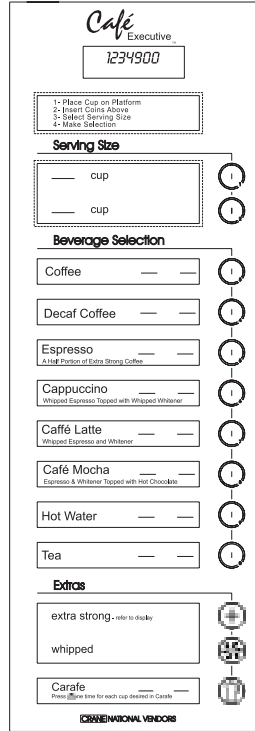

DUAL SELECTION

688p0047

FACTORY DEFAULTS AND DRINK SIZES

Your machine is pre-loaded with factory default times for dispensing 8¼ oz and 12 oz drinks. To change one or both drink sizes, or to dispense one drink size only, use the following procedure:

1. Set drink sizes:

The display will show *DEFAULTS* for a moment, then you will see something like this:

8.OZ.12

The number on the left represents the size of a regular drink. In this exam-

ple, an 8 ounce drink. You can change the drink size by pressing 

until the desired size is displayed. Your choices are: 5, 7, 8, 9, 10, 12, and ---. The number on the right represents the size of a large drink (12

ounces in this example). You can change the drink size by pressing 

until the desired size is displayed.



2. Enter defaults for one drink size only:

CAUTION THIS WILL ERASE ANY CUSTOM DISPENSE TIMES YOU HAVE ESTABLISHED FOR ALL SELECTIONS IN THIS SIZE!!

- a. Lock out the size (regular or large) you DO NOT want to enter defaults for by setting it to ---.

NOTE



This setting only inhibits loading defaults for this size. It **WILL NOT** inhibit this cup size from vending.

- b. Press  and . When the transfer is finished, the display shows *FINISHED*.

3. Enter defaults for both drink sizes at one time:

CAUTION THIS WILL ERASE ANY CUSTOM DISPENSE TIMES YOU HAVE ESTABLISHED FOR ALL SELECTIONS!!

- a. Make sure both selections display the desired drink size.

- b. Press  and . When the transfer is finished, the display shows *FINISHED*.

Café Executive Setup

4. The values entered at this display also control the single or dual size setting for the machine. If both sizes are the same (8 oz 8 oz) then the machine will vend only regular drinks. If different sizes are selected (8 oz 12 oz) the machine will vend regular and large sizes.

FILTER PAPER ADVANCE DELAY TIME

After a vend, the filter paper advances, but the wet part of the paper remains in contact with the brewer. If too much time passes between vends, this wet paper may dry and stick to the brewer, causing problems. To advance the paper before this happens, use the following procedure:

1. The display shows *ADV. XXX*. "XXX" is the time (**in minutes**) between a vend and when the filter paper advances one more time.
2. Using the number keys, enter the desired time. Entering a zero (0) will disable this feature.

NOTE







Since filter paper drying times will vary depending upon your location, you should experiment with different times. Advancing the paper too soon will waste paper; advancing it too late will allow it to stick to the brewer.

SET PRICES FOR PRICE LINES

Prices are set for selections in two steps: 1) A price is set for a price line, then 2) A price line is assigned to the selection.

TIME SAV- ING TIP

When you have more than one selection with the same price, you can save time by assigning the same price line to each of those selections. For example, the 1.3, 1.4, and 1.5 selections are all assigned to a price line number that is priced at \$0.45. Now the price goes up to \$0.50. Instead of changing each individual price, you just change the price of the price line number assigned to those three selections. A total of 16 different price lines are available for multiple drink pricing.





1. Open the door and insert your key in the carafe key switch. Turn the key 90° clockwise to the ON position.
2. Press , then  to enter the **PRICE LINE MODE**.
3. The display shows: *PR.1 X.XX*. X.XX is the price that is currently assigned to **PRICE LINE NUMBER 1**. You can change this by entering a new price with the number keys. For example, enter , then . You have assigned a price of 35 cents to that price line number. Your display will now show: *PR.1 .35*.
4. Press  to display the remaining seven price line numbers. Repeat step 3 until all desired price line numbers are set up.
5. Press  twice to leave the PRICE LINE MODE.

IMPORTANT







After prices have been set for each of the price lines, you must assign a price line to each selection. See SET UP SELECTIONS in the following section.

Café Executive Setup

SET UP SELECTIONS



1. Open the door and insert your key in the carafe key switch. Turn the key 90° clockwise to the ON position.
2. To set up a regular size drink, press , then , followed by the selection number. To set up a large size drink, press , then , followed by the selection number.
3. Press  to scroll through the settings for the current selection. The price line assignment, timer codes, definitions, allowable range, and increments are shown in the table on the next page.

NOTE: Some of the codes may not show up, depending upon machine configuration and the type of product being set up.

4. You can change the displayed settings by pressing the appropriate number keys. For example, let's set up your   selection. This selection is typically hot chocolate, so some of the codes and options will not show up.
 - a. The display shows: *18.5 PR.5*. This means that the selection is currently assigned price line number 5. Press . You have re-assigned price line number 3 to the selection, and your display now shows: *18.5 PR.3*.
 - b. Press . The display shows: *18.A 8.25*. This means that the water time for the selection is currently 8.25 seconds. Enter   . You have increased the water time to 8.50 seconds, and your display now shows: *18.A 8.50*.

Café Executive Setup

To check water settings, first disconnect the water line leading from the water valve to the brew cylinder. Collect the water for measurement at the free end of the water line in a measuring cup or graduated cylinder. **BE CAREFUL OF THE HOT**

WATER!!!! Press  , then  . The water valve opens, and you can measure the dispensed water volume with a graduated cylinder. Refer to the water volume chart in Appendix C.

NOTE



To disable this or any other individual drink selection, enter a zero for the water time.

CODE	DEFINITION	RANGE	INCREMENT
\$	Price line assignment NOTE Before assigning a price line to a selection, set the prices for each of the price lines. See SET PRICES FOR PRICE LINES in the previous section.	1 - 8 (8 prices)	N/A
A	Water dispense time.	0 - 99.95 seconds NOTE Time must be greater than 0, or selection is disabled. To disable this or any other individual drink selection, enter a zero for the water time.	0.05 second steps
B	Product dispense time.	0 - 12.75 seconds	0.05 second steps
B+	Extra strong product dispense time (freeze dried and fresh brewed).	0 - 12.75 seconds	0.05 second steps
C	Steep time (brewed drinks only)	0 - 99.5 seconds	0.5 second steps
C+	Total steep time for an extra strong brewed drink	0 - 99.5 seconds	0.5 second steps



Café Executive Setup

CODE	DEFINITION	RANGE	INCREMENT
D	Pump time (brewed drinks only)	0 - 99.5 seconds NOTE Must be greater than twice the water time, or selection is inhibited.	0.5 second steps
E	Whitener product dispense time	0 - 12.75 seconds	0.05 second steps
F	Second product dispense time	0 - 12.75 seconds	0.05 second steps
F+	Extra strong second product dispense time.	0 - 12.75 seconds	0.05 second steps
G	First product percentage (% decaf coffee to regular coffee, % chocolate to coffee, or % whitener to coffee)	5% - 95%	1% steps
H	Second product percentage (% chocolate to coffee) for Cafe' Mocha.	5% - 95%	1% steps
*	Selections always whipped (ON) or optionally whipped (OPT)	ON or OPT	N/A





c. Press . The display shows: **18.B 4.65**. This means that the product dispense time is currently 4.65 seconds.

Enter   . You have reduced the product dispense time to 4.45 seconds, and your display now shows: **18.B 4.45**.

To check water settings, hold a container under the canister spout.

Press  , then . The canister motor will run and you can measure the dispensed product using a suitable gram-measuring scale or balance.



d. Press . The display shows: **18.B+ 4.65**. This means that the extra-strong dispense time for hot chocolate is currently 4.65 seconds. You want to leave this time alone, so don't enter anything.

- e. Press . The display shows: *18.* 0N*. This means that hot chocolate is always whipped. Press . The display now shows: *18.* OPT*, and the customer has to press  to get a cup of whipped hot chocolate.
- f. Press . The display shows: *18.5 PR.3*. This means you have finished with the setup for this selection. Other selections will have more options, such as ground coffee, but they are handled in the same way.

5. Press twice to exit the **SETUP** mode.
6. If your machine is configured with whitener, you have the capability of dispensing additional drinks, including Café Mocha, Cappuccino, and Caffè Latte. These new drinks allow for full control over the timers. In addition, there is a percentage screen which allows you to compute approximate times for these drinks as a "starting point" for setup.

When computing new times for Café Mocha, Cappuccino, and Caffè Latte, the program uses times from existing coffee, hot whitener, and hot chocolate drinks (base drinks) if they are available. If those drinks do not exist, then standard default times will be used in the computation. For the most accurate computed times, set up the "base" drinks prior to the multi-product recipes.







To use this feature, execute the setup selection sequence for the key programmed to Café Mocha, Cappuccino, and Caffè Latte. Step down to the appropriate percentage code "G". "G" is used for all three drinks; "H" is only used for Café Mocha. Enter the desired percentage(s), then press

s  and . The new times are then computed and entered.

Press  repeatedly to step down and view the new times.





Café Executive Setup

SETTING TIME AND DATE

1. Open the door.
2. Enter TIME/DATE mode by pressing  followed by **6**. The display shows *SET - 4:29 PM*. (The currently set time is 4:29 in the afternoon.) The colon will be flashing to indicate a live display.
3. Enter the correct time by pressing the number keys. While entering a new time, the colon will stop flashing to indicate the clock is being changed.
4. Select AM, PM, or 24-hour mode by pressing  until your choice is displayed.
5. To set the date, press  and proceed to step 6. If you don't want to set the date, press  twice to exit the function. Either keypress will lock in the time you have set.
6. The display shows *SET - 8/24/99*. (The currently set date is August 24, 1999.)
7. Enter the correct date using the number keys.
8. To select between the U.S. date format (mm/dd/yy) and the European date format (dd-mm-yy), press  until your choice is displayed.
9. Your new date is saved as soon as it is entered. If you accidentally enter an invalid date, the display will return to the original date.
10. Press  twice to exit the function.

OPERATION

MAKE A SINGLE DRINK

1. Place a cup or mug on the cup platform.
2. Press  to select a regular size drink, or  to select a large size drink.
3. Press the desired selection. For example, press  to select the product in canister #1. **For extra strong, press .** **To whip your drink, press .**

MAKING A CARAFE

Any valid drink shown on the menu may be served into a carafe as follows:

1. Place your carafe on the carafe platform. (This will push the cup platform inside the machine and out of your way.)
2. Press . The display shows either:

CUPS1 = No code is required to vend a carafe; continue with step 3.

- OR -



CODE XXX = A code is required to vend a carafe; enter it now and continue with step 3.

3. Continue pressing  until the number of cups your carafe will contain is displayed.

HELPFUL HINT:

If, for example, your machine is set up to vend 8-ounce regular drinks and 12-ounce large drinks, a 60-ounce carafe will fill up faster if you select five large drinks instead of seven regular drinks.

Café Executive Setup

4. Press  or , then your selection. The display shows the cup number counting down. If you decide you don't want as much in your carafe as you first selected, you may press  at any time to stop. Dispensing stops after the current cup is complete.
5. When the last cup has vended, the machine goes back to the single vend mode. To fill another carafe, return to step 1.
6. **If your machine has a coin mechanism**, deposit at least enough money to pay the cost of the number of cups you are going to vend. If you have change coming, the machine will pay the change after the last cup is vended. If you didn't deposit enough money, the machine will not vend. You must deposit sufficient credit to cover the number of cups requested.

Café Executive Setup

SCROLLING MESSAGES

When certain errors occur, you will see a message scrolling on the display. These messages call attention to conditions which can be remedied by someone at the location without the need of a service technician. The following table lists the message, what can be done about it, and a reference to the corresponding error message in the FAULT ISOLATION section.

DISPLAY	CORRECTIVE ACTION	CORRESPONDS TO...
<i>NO FILTER PAPER</i>	Add filter paper (if empty). Check to see that the paper is properly positioned under the empty switch and under the paper rollers.	<i>NO PAPER</i>
<i>DRAIN TRAY IS FULL</i>	The drain tray is filled with liquids - empty the tray. If the tray is empty, the float is most likely resting on the platform and not hanging in the float well. Position the float so it hangs freely in the well. It will slightly touch the bottom of the drain tray.	<i>TRAY.FULL</i>
<i>GROUNDSPAIL IS FULL</i>	Empty the coffee grounds pail and reset the pail count (see MAINTENANCE).	<i>PAIL.FULL</i>
<i>COLD WATER - TRY LATER</i>	Check for leaks, pinched water line, closed water valve, or a closed water filter valve. If these are ok, perform the procedures given in FILL WATER TANK.	<i>LOW TEMP</i>
<i>RESET THE BREWER</i>	The brewer is in the CLAMP position. Cycle the brewer (see Test Brewer Operation in the MAINTENANCE section). NOTE The machine will attempt to pump any water out of the brewer before it unclamps.	<i>BREWERR</i>

Café Executive Setup

DISPLAY	CORRECTIVE ACTION	CORRESPONDS TO...
<i>MAKE ANOTHER SELECTION</i>	This display occurs when selections are locked out. Perform the Lock Out Selections procedure in the MAINTENANCE section to unlock selections as appropriate. If all selections are locked out the display will read <i>ALL SELECTIONS LOCKED OUT.</i>	<i>LOCKED</i>

OTHER PROBLEMS AND SOLUTIONS



PROBLEM	SOLUTION
The display is not lit.	Check to see if the machine is plugged into the wall receptacle.
The unit will not take money.	Is the unit on free vend? To check, perform the steps given in SET UP CONFIGURATION. If the machine is on free vend, turn free vend off.
Some keys will not work in the programming mode.	You are not authorized to use these functions. Contact your supervisor.

1. Open the door.
2. Either:

Press . If there are no faults on the machine, *-NOERR-* is displayed.

If a fault is displayed, continue pressing  to view all faults. The standby message is displayed following the last fault.

- OR -

Press , then  to see the list of faults. If there are no faults on the machine, *-NOERR-* is displayed. Possible faults are as follows:

Café Executive Setup

DISPLAY	DEFINITION	CORRECTIVE ACTION
<i>CONF.ERR</i>	Configuration error	Check configuration code is correct
<i>TRAY.FULL</i>	Drain tray is full	Empty drain tray, ensure switch is not sticking
<i>PAIL.FULL</i>	Grounds pail is full; pail count has been reached	Empty grounds pail, reset counter
<i>NO PAPER</i>	No filter paper	Install more filter paper, make sure paper is properly fed through switch
<i>LOW TEMP</i>	Low water temperature	Let water reach proper operating temperature, make sure heater is working
<i>SENSOR</i>	Temperature sensor has failed	Check harnessing from PCB to float assembly, change float assembly
<i>TANK ERR</i>	Tank failed to be filled/refilled	Check for leaks, reset error and allow tank to continue filling
<i>BREWERR</i>	Brewer is in incorrect position	Run brewer test
<i>BREW JAM</i>	Brewer has jammed	Free brewer jam
<i>WHIP123</i>	Whipper has jammed	Free whipper jam, replace whipper
<i>NO MECH</i>	Coin mech has a fault, controller not communicating with coin mech	Replace coin mech, check wiring
<i>NO.BREWER</i>	Machine detected a missing or malfunctioning brewer	Check harnessing and brewer switch assembly
<i>ROMERR</i>	EPROM checksum failed	Replace the EPROM or check the controller

3. Take the appropriate corrective action.

SERVICE KEYPAD

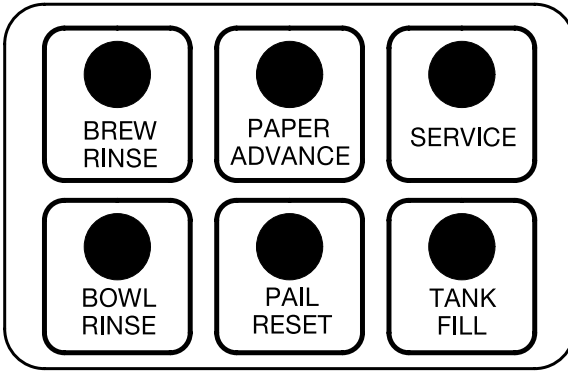

688p0019

The service keypad gives you easy one-push access to certain troubleshooting and maintenance functions. Press the appropriate key to do the following:

BREW RINSE.....Rinses the brewer. “RINSE BREWER” on page 57

PAPER ADVANCE..Runs the brewer and advances the filter paper (helpful while loading paper to verify proper operation). “TEST BREWER OPERATION” on page 57

BOWL RINSERinses the mixing bowl(s). “RINSE MIXING BOWL” on page 57



PAIL RESETResets the grounds pail count to zero. “CLEAR GROUNDS PAIL COUNT” on page 56

SERVICEPress once to view the water tank temperature (tank temperature is displayed in either Fahrenheit or Celsius, depending upon the configuration setting). “WATER TANK TEMPERATURE DISPLAY” on page 49 Press twice to view the input switch status. “INPUT SWITCH TESTS” on page 51.

TANK FILLFills the water tank and/or clears a *TANKERR* message. “WATER TANK FILL” on page 49

TESTING

You can check out certain areas of your machine's operation. Some frequently used functions are available with one keypress. See the **SERVICE KEYPAD** section for more information:

1. Insert your key in the carafe key switch and turn it 90° clockwise to the ON position.
2. Press , then  to enter the **SERVICE MODE**.
3. Press  to move through the following selections:

NOTE



Some of these functions can be reached directly using the service keypad. See that section for more details.

WATER TANK TEMPERATURE DISPLAY

The tank temperature is displayed in either Fahrenheit or Celsius, depending upon the configuration setting. To set the tank temperature setpoint, see **SETUP CONFIGURATION**.

WATER TANK FILL

For safety purposes, the water inlet valve is not allowed to operate with the tank water level in the low condition for more than one minute. After that, a **TANK ERR** message is displayed if the tank is not filled to its proper level. To clear that error, or to initially fill the water tank (which takes more than 1 minute), proceed as follows:

1. The display shows: **TANK.FILL**.
2. Press , then . The display shows: **FILLING**. This indicates that the tank is filling and/or the error is cleared. When the tank is full, the display returns to **TANK.FILL**.
3. If it is taking longer than 6 minutes to fill the tank AND THERE ARE NO LEAKS, you may see the **TANKERR** message again. Just repeat step 2 after making sure there are no other problems, such as a restriction in the water inlet line.



NOTE

The heater does not function until the tank is full. The normal heat up time to reach operating temperature is 45 minutes.

Café Executive Setup

PUMP TEST

The display shows: *PUMP*. To test liquid pump operation, proceed as follows:





1. Press , then . The display shows: *PUMP X*, and counts down the time (X) remaining on the pump test.

NOTE

If the brewer is clamped at the start of this test, the pump will run much longer in order to evacuate any remaining liquid.

BREWER TEST (MACHINES WITH BREWERS ONLY)

The display shows: *BREWER*. To test brewer operation, proceed as follows:

1. Press , then . The display shows: *MOVE -2*. This indicates that the brewer is moving to its closed position. When it reaches that position, the display shows: *CLAMP 1-* (1 is the switch that is closed when the brewer is clamped).
2. Press , then . The display shows: *MOVE 1-*. This indicates that the brewer is moving to its opened position. When it reaches that position, the display shows: *OPEN -2* (2 is the switch that is closed when the brewer is open).

WHIPPER TEST

The display shows: *WHIP TEST*. To test an individual whipper, press the number corresponding to the whipper you want to test. The display shows *WORKING*





while the whipper is running, then returns to *WHIP TEST*. Pressing ,

then  tests only the first whipper.



INPUT SWITCH TESTS

The display shows: *IN. 123-*. The numbers 1, 2, and 3 and the dash each correspond to one of the input switches: Water tank level switch - 1, Liquid drain tray float switch - 2, Filter paper sold-out switch - 3, Water tank low level switch - dash (-). As you actuate the overflow tray float and filter paper sold-out switches, watch the number in the display change to a dash. Obviously you cannot manually actuate the tank level switch, but when the tank is full, the display shows *IN. 123-*. When the water is between the full and low switch levels, the display shows *IN. -23-*. Finally, when the water is below the low level, the display shows *IN. -234*.

KEYPAD TEST

The display shows *KEYPAD*. Press any key to test its operation. (For example, pressing  shows all "3"s in the display.) Press  and  to test all segments in the 8-character vacuum fluorescent display. The displays remain lit until you press  again.

DATA COLLECTION

1. Open the door and insert your key in the carafe key switch. Turn the key 90° clockwise to the ON position. Press , then  to enter the **DATA MODE**.

TOTAL SALES

1. The display shows *SALES* for a moment, then *\$ XXXX.XX*. The "X"s represent the dollar figure of sales made by the machine. This total is NOT resettable.
2. Press  to advance through the following displays:

TOTAL VENDS

1. The display shows *VENDS* for a moment, then ** XXXXXX*. The "X"s represent the total vends made by the machine. This total is NOT resettable.

Café Executive Setup

VENDS BY PRICE LINE

1. The display shows how many vends were made from each price line. Examples:

PD.1 25. This represents **25** paid vends (**PD**) from price line **1**.

- OR -

FR.4 10. This represents **10** free vends (**FR**) from price line **4**.

Pressing  shows all the price lines which have had vends. **NOTE:** If a price line has not had a vend, it will not be displayed. These displays are resettable.

CLEAR INFORMATION

The display shows: *CLEAR X*. This means that the resettable data has been cleared X number of times. This total is not resettable. Press ,

then  to clear the resettable data. The *VENDS BY PRICE LINE* displays will be reset to zero, and will not be displayed until vends have been made. The *CLEAR* display is incremented by one.

1. Press  twice to leave the DATA mode.

MISCELLANEOUS

SOFTWARE VERSION NUMBER

The version number of the current software is displayed. Press









and  to compute and display the EPROM checksum. A typical display will show *SUM 752C*. The checksum is the four character alpha-numeric on the right. This number must correspond to the number label attached to the EPROM chip itself.

Café Executive Setup

PAYOUT

This feature is only available if you have a coin mechanism other than an exec mech installed in your machine.

1. Open the door and insert your key in the carafe key switch. Turn the key 90° clockwise to the ON position.
2. Press , then  to enter the **PAYOUT MODE**.
3. The display shows *NOQ 345*. This means that pressing  causes the coin mech to pay out Nickels, pressing  pays out Dimes, and pressing  pays out Quarters.
4. Press  twice to leave the **PAYOUT MODE**.

ROUTINE MAINTENANCE

NOTE

Some of these functions can be reached directly using the service keypad. See that section for more details.

Before performing the following steps, open the door.

EMPTY THE LIQUID DRAIN TRAY

1. Lift the float and chain assembly out of the drain tray.
2. Pull the drain tray straight out of the machine.
3. Empty the drain tray in a suitable location, and clean it in accordance with the sanitation instructions. The plastic carafe platform is removable for easy cleaning by lifting it out of the tray.
4. Replace the drain tray in the machine.

EMPTY THE GROUNDS PAIL



1. Remove and empty the drain tray (see above). Be careful not to spill any liquid.
2. Tear off filter paper at brewer housing. Place all used grounds and paper in the grounds bucket.
3. Remove the grounds pail from the machine.
4. Empty the grounds pail and clean it in accordance with the sanitation instructions.
5. Replace all parts in reverse order of disassembly.
6. Clear the grounds pail count (see below).
7. Re-feed filter paper as explained previously.

Café Executive Setup

NOTE

This item will not display if no tank error exists.

RESET TANK ERROR

1. Press  until the display shows *TANK FILL*. Press , then . This clears any tank error and starts filling the tank, if necessary.
2. If it is taking longer than 1 minute to fill the tank **AND THERE ARE NO LEAKS**, you may see *TANKERR* in the diagnostic list again. Just repeat steps 1 - 3 after making sure there are no other problems, such as a restriction in the water inlet line or a clogged water filter.



NOTE

The heater will not function until the tank is full. The normal heat up time to reach operating temperature is 45 minutes.



CLEAR GROUNDS PAIL COUNT

NOTE

This item will not display if the vend limit was set to 0 during CONFIGURATION.

1. Empty the grounds pail.
2. Press  until the display shows *PAIL X*. X represents the number of brewed selection vends which have taken place since the last time the counter was cleared. Normally you will be clearing this after you have emptied the grounds pail.
3. Press , then  to clear the vend count. The display shows *PAIL 0*.

TEST BREWER OPERATION



1. Press  until the display shows *BREWER*. Then, press  and  to test the brewer. The brewer runs, the paper advances, and the display shows the remaining pump time (if any), then returns to *BREWER*.

RINSE BREWER

1. Press  until the display shows *BREW RIN*.

CAUTION

Rinse water is **hot**. Be careful not to get any on you during the following steps.

2. Place a cup or other suitable container below the dispensing nozzles to catch the **HOT** rinse water.
3. Press  and  to rinse the brewer. The brewer closes, hot water runs through the brewer, the pump and coffee whipper run, and the display shows *RINSING*, then returns to *BREW RIN*.

RINSE MIXING BOWL

1. Press  until the display shows *BOWL RIN*.

CAUTION

Rinse water is **hot**. Be careful not to get any on you during the following steps.

2. Place a cup or other suitable container below the dispensing nozzles to catch the **HOT** rinse water.
3. Press , then to rinse the bowl. Hot water runs through all mixing bowls, each whipper runs, and the display shows *RINSING*, then returns to *BOWL RIN*.

CHANGE FUSES

NOTE

An internal 4-amp fuse **ONLY** protects the electronics inside the machine.

FUSE TYPE: 4A, 250V, MDL4 Time Delay Glass Cartridge

REPLACE FUSE WITH ONE OF THE SAME TYPE AND RATING

1. Unplug the machine.
2. Remove all canisters (see above). Remove valve cover.
3. Loosen the two screws holding the cabinet electronics cover. Remove the cover.
4. The fuse is located in a clip near the left side of the cabinet controller.
5. Remove the old fuse by pulling straight out of the clips. Install new fuse.
6. Replace all parts in reverse order of assembly. Plug in the machine.

ADJUST WATER VALVES

The water valves are factory set and should not need to be adjusted. However, if you can't get the water volume you need by adjusting the water throw time alone, then go ahead and adjust the valves. Do this in conjunction with setting the factory default timers during the Product Configuration programming mode.

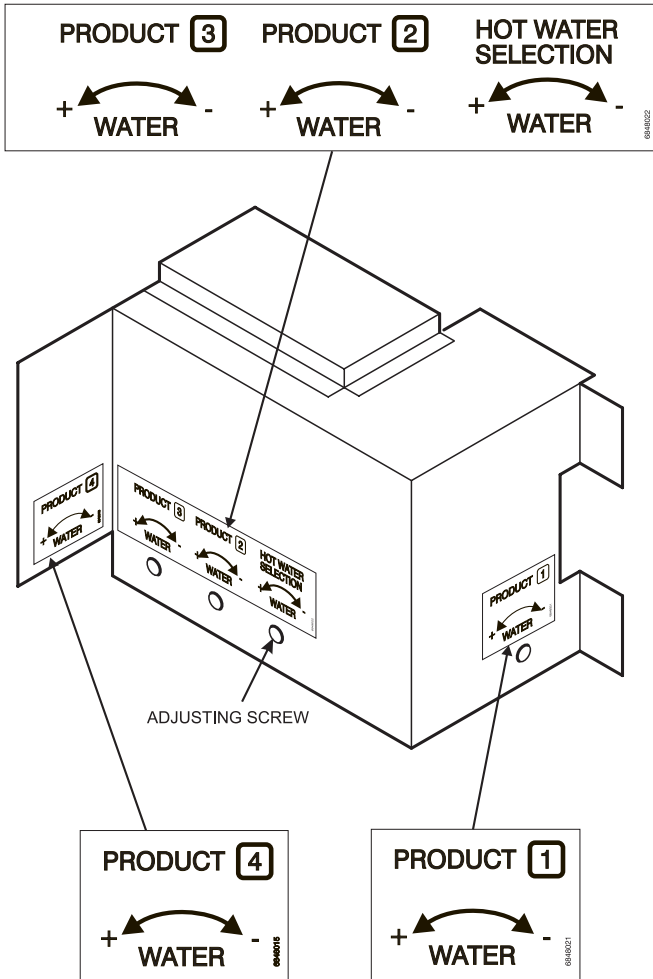

688p0046

1. Using a slotted screwdriver, turn the adjustment screw clockwise to decrease the water flow rate.
2. Turn the adjustment screw counterclockwise to increase the water flow rate.

CLEANING AND SANITATION

CLEANING

Cleaning means “making free of visible soil”. In cup vending machine servicing, cleaning is also done to maintain product quality and to remove food soils, oils, and mineral stains that could affect product taste, aroma, and appearance.

SANITIZING

Sanitizing means the reduction, to safe levels, of the number of disease-causing bacteria that remain on the surface **after** cleaning. Therefore, cleaning and sanitizing are done in separate steps, as prescribed by health regulations and good industry practice.

Anybody who services vending machines must use proper sanitizing procedures. Health regulations require that hands be clean when cups, commodities, and food-contact parts are handled or serviced.

In addition, Federal and State Health Departments require regular cleaning and sanitizing procedures for food contact parts.

The information in this section will explain how to clean and sanitize the machine on a day to day basis. A clean and well maintained machine will provide a better product and greater safety for your customers.

HOW DO I SANITIZE?

You can sanitize by using either of these two methods:

Chemicals The object to be sanitized is treated with a bactericidal compound.

Heat Raise the temperature of the object high enough to kill bacteria. Water must be at least 170° F.

Unplug the machine before using water on the machine.

In either case, the object must be thoroughly clean and completely rinsed in order for the sanitizing process to work. Caked-on soils not removed by cleaning, for example, may shield bacteria from a sanitizing solution.

A GOOD PLACE TO START -- YOUR SANITATION KIT

You need to be sure that each machine is clean, safe, and functioning when you leave it. In order to properly do this, you need to have a complete set of the right tools. In addition to the screwdrivers, pliers, and test equipment necessary to repair a machine, you need to have the tools to clean the machine.



Here is a checklist of the items needed for a good sanitation kit:

- ✓ Sanitation pail
- ✓ Tube and nozzle brushes for food contact surfaces
- ✓ Utility brush for dry spillage around canisters, etc.
- ✓ Disposable towels, wet-strength and lint-free

NOTE

Wiping with towels can re-contaminate sanitized food-contact parts. Therefore, towels should not be used to dry food-contact surfaces. Instead, these parts should be air dried.

- ✓ Spray detergent, diluted to desired strength
- ✓ Urn cleaner packets for coffee stains and oils
- ✓ Odor control chemicals for pails
- ✓ Replacement parts (if the exchange method is used)
- ✓ Cabinet polish or window cleaner for the outside of the machine

Feel free to add some items to this list. For example, you may want to use a portable vacuum cleaner.

Café Executive Setup

SANITATION PROCEDURES

Your machine has been specially designed for easy disassembly without tools. Refer to the recommended cleaning and sanitation interval table on the final page of this section. For each item, complete the procedure as outlined here.

FOOD-CONTACT PARTS

NOTE

All food-contact parts must be cleaned and sanitized. Air dry, do not wipe dry.

Canisters - Empty and wash the canisters, augers, and spouts. Sanitize with hot water and allow to air dry completely before returning to cabinet.



Mixing Bowls - The inside of all mixing bowls can be rinsed as follows:

Press  until the display shows *BOWL RIN*.

CAUTION

Rinse water is **hot**. Be careful not to get any on you during the following steps.

Place a cup or other suitable container below the dispensing nozzles to catch the **HOT** rinse water.

Press , then  to rinse the bowl. Hot water runs through all mixing bowls, each whipper runs, and the display shows *RINSING*, then returns to *BOWL RIN*.

Beverage Discharge Nozzles - Disconnect the beverage dispensing tube from the nozzles. Remove the nozzles from the mounting bracket. Remove the cap from the nozzle, wash clean and sanitize the nozzles and cap.



Brewer -

Press until the display shows *BREW RIN*.

CAUTION

Rinse water is **hot**. Be careful not to get any on you during the following steps.

Place a cup or other suitable container below the dispensing nozzles to catch the **HOT** rinse water.

Press , then  to rinse the brewer. The brewer closes, hot water runs through the brewer, the pump and coffee whipper run, and the display shows *RINSING*, then returns to *BREW RIN*.

Ingredient Chutes - Remove the chute(s), wash clean, and sanitize by rinsing with hot water. Air dry before reinstalling.

Whippers and Impellers -

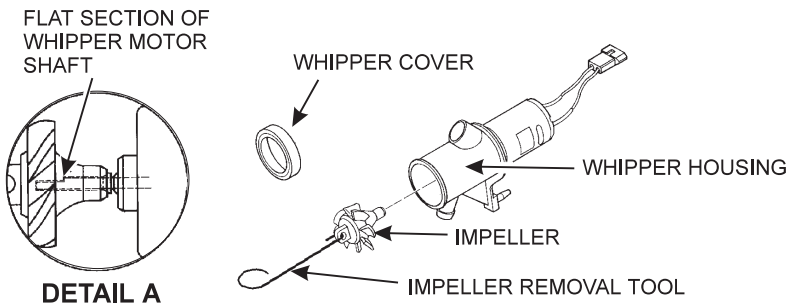

- Remove the whipper cover.
- Using the impeller removal tool (located in the plastic bag assembly), remove the impeller from the whipper housing as shown.
- Wash the cover, impeller, and impeller housing. Sanitize with hot water and allow to air dry before reassembling.
- To reassemble, see detail A. Note that the whipper motor shaft has a flat section. Make sure this flat section lines up with the "D" shaped hole in the impeller. Press the impeller all the way onto the whipper motor shaft. Replace the cover.

Café Executive Setup

Brewer Mechanism Cleaning - Remove the brewer assembly to clean. See **CLEAN THE BREWER.**

NON FOOD-CONTACT PARTS

Exhaust Fan Filter - Remove the filter from its housing. Wash with soap and water, rinse, wring dry, and replace into housing.

Grounds Pail - Empty and rinse the grounds pail.

Liquid Drain Tray - Empty, wash, and rinse with hot water. Sprinkle detergent powder in the bottom of the tray to help control odors. You might want to save this until last, because the waste water from rinsing the bowls and brewer will collect here.

OVERALL CLEANING

Inspect your machine both inside and out. Be sure to check corners and all less visible parts of the machine.

Clean where needed.

Allow the inside of the cabinet to dry thoroughly before you close the door.

National Vendors recommends using the following supplies:

A mild detergent and warm water on the cabinet, brewer, and other **NON ELECTRICAL** components.

CAUTION

The plastic parts in your machine should be cleaned with mild detergent and warm water. The use of other cleaning agents may damage the material, and should be avoided.

PREVENTIVE MAINTENANCE CLEANING

Periodically, you should visually inspect your machine's hot water tank for excessive lime and scale buildup. This buildup on the tank walls, water valves, and heater element will vary dramatically, depending upon water quality. You should develop a cleaning and deliming schedule based on the apparent local water quality.

NOTE

To aid in removing scale from your machine, National Vendors has a service kit available: part number 6400080. In addition, if your machine has the Everpure water inlet filter system option, a second kit (part number 6400086) is also available.

CLEAN THE BREWER

The brewer has two main parts you can remove: the brew barrel and the screen and seal assembly. You can remove them with the brewer in the machine, or the entire brewer can be removed as one unit.

1. On the left side of the brewer, cut off and discard the filter paper.
2. Remove the hose at the top of the brew barrel.
3. Grasp the top of the brew barrel, and turn it $\frac{1}{4}$ turn to the left as shown. Lift straight up and remove.

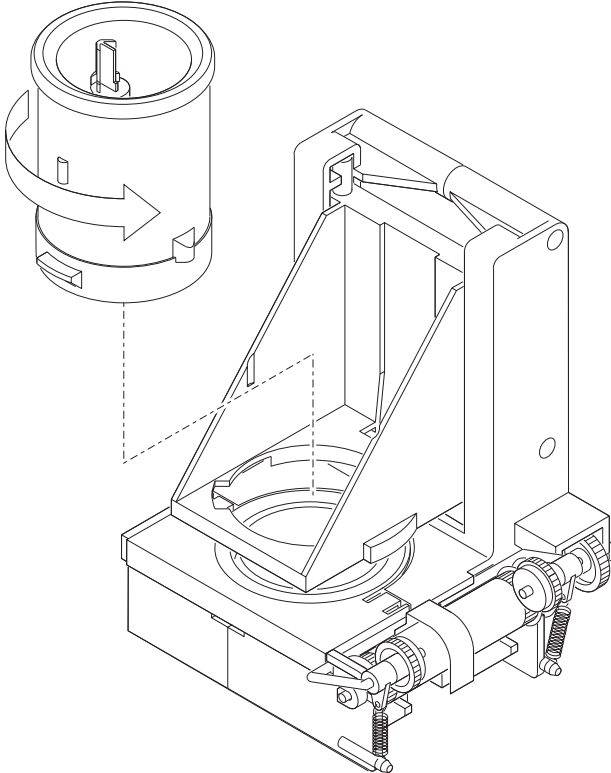

4. Remove the hose from the bottom of the screen and seal assembly.

Café Executive Setup

5. At this point, you can remove the brewer or leave it in the machine.
 - a. To remove the brewer, pivot the bottom of the unit up toward you, lift upward slightly, and pull straight out.
6. Remove the screen and seal assembly as shown:
 - a. Press down on the tabs with your fingers, and slide straight back.
 - b. Lift straight up and pull out.

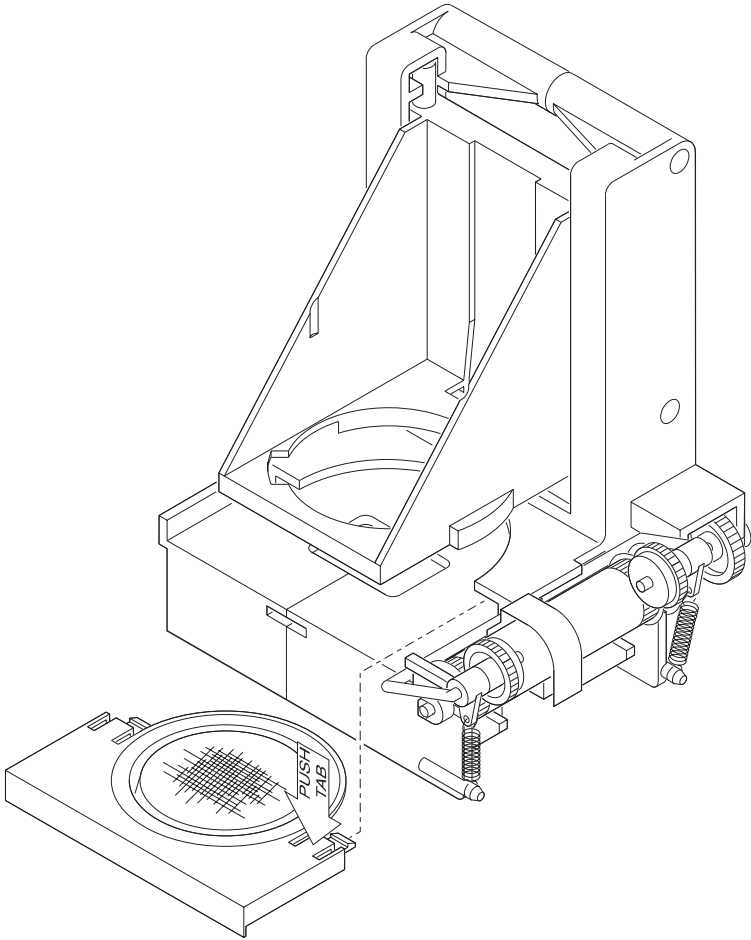

Café Executive Setup

7. Thoroughly wash all parts using soap and water. Sanitize by rinsing thoroughly with hot water. Air dry, or blow dry with compressed air (if available).
8. If you removed the brewer, make sure the motor drive link is aligned as shown.

If the motor drive link is aligned properly, the notch in the cam wheel will capture the bearing.

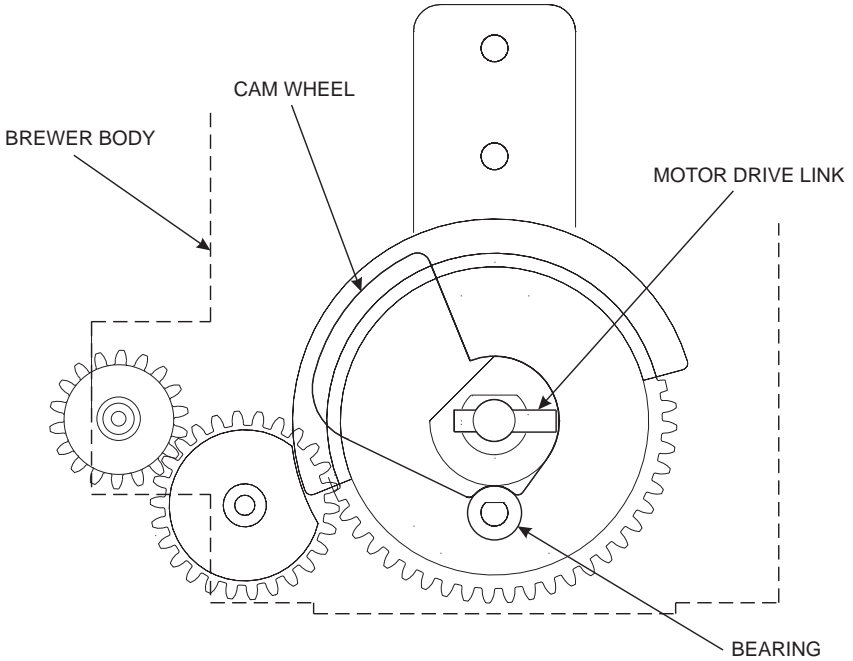

Café Executive Setup

If the motor drive link is not aligned properly...

The notch in the cam wheel is turned away from the bearing. You must manually turn the cam wheel to capture the bearing in the notch.

9. Assemble in the reverse order of disassembly. **NOTE:** when replacing the screen and seal assembly, make sure you hear **TWO CLICKS** as you push it all the way in.
10. Feed new filter paper through the brewer, and don't forget to connect the hoses!

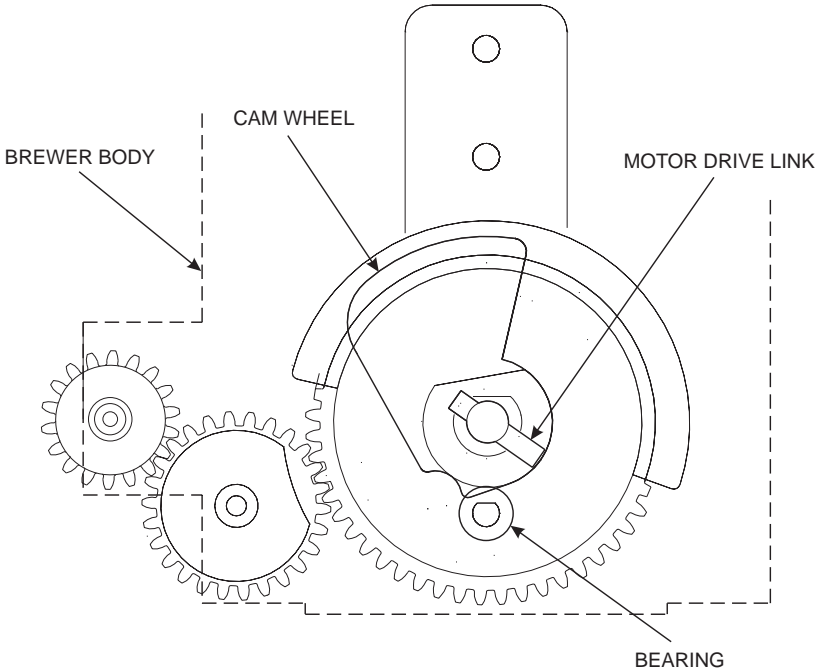

SANITATION INTERVALS

RECOMMENDED CLEANING AND SANITATION INTERVALS

CATEGORY	ITEM	DAILY	WEEKLY	MONTHLY
BREW SECTION	Brewer Cylinder, Funnel	R		
	Brewer Mechanism			
	Mixing Bowl	R		
	Whippers	R		
DRY SECTION	Ingredient Canisters			C/S
	Ingredient Chutes		C/S	
WASTE SECTION	Liquid Drain Tray	C		
	Exhaust Fan Filter & Screen			C
	Grounds Pail	C		
	Cup Support & Drain Tray Cover	C		
WATER SECTION	Beverage Discharge Nozzles		C/S	
	Water Filter Service			Check

S = Sanitize at this interval

R = Rinse at this interval

C = Clean only at this interval

Café Executive Setup

Make copies of this cleaning record, cut it out, and keep it in a safe place. It will be your record of cleaning all four areas of your machine.

RECORD OF CLEANING					
(YEAR) _____					
	BREW SECTION	DRY SECTION	WASTE SECTION	WATER SECTION	BY
JAN	<input type="checkbox"/>	<input type="checkbox"/>	<input type="checkbox"/>	<input type="checkbox"/>	<input type="checkbox"/>
FEB	<input type="checkbox"/>	<input type="checkbox"/>	<input type="checkbox"/>	<input type="checkbox"/>	<input type="checkbox"/>
MAR	<input type="checkbox"/>	<input type="checkbox"/>	<input type="checkbox"/>	<input type="checkbox"/>	<input type="checkbox"/>
APR	<input type="checkbox"/>	<input type="checkbox"/>	<input type="checkbox"/>	<input type="checkbox"/>	<input type="checkbox"/>
MAY	<input type="checkbox"/>	<input type="checkbox"/>	<input type="checkbox"/>	<input type="checkbox"/>	<input type="checkbox"/>
JUN	<input type="checkbox"/>	<input type="checkbox"/>	<input type="checkbox"/>	<input type="checkbox"/>	<input type="checkbox"/>
JUL	<input type="checkbox"/>	<input type="checkbox"/>	<input type="checkbox"/>	<input type="checkbox"/>	<input type="checkbox"/>
AUG	<input type="checkbox"/>	<input type="checkbox"/>	<input type="checkbox"/>	<input type="checkbox"/>	<input type="checkbox"/>
SEP	<input type="checkbox"/>	<input type="checkbox"/>	<input type="checkbox"/>	<input type="checkbox"/>	<input type="checkbox"/>
OCT	<input type="checkbox"/>	<input type="checkbox"/>	<input type="checkbox"/>	<input type="checkbox"/>	<input type="checkbox"/>
NOV	<input type="checkbox"/>	<input type="checkbox"/>	<input type="checkbox"/>	<input type="checkbox"/>	<input type="checkbox"/>
DEC	<input type="checkbox"/>	<input type="checkbox"/>	<input type="checkbox"/>	<input type="checkbox"/>	<input type="checkbox"/>

**APPENDIX A.
FACTORY DEFAULT TIMES**

FRESH BREW DRINKS

CUP SIZE	"A" WATER	NORMAL "B" PRODUCT"	EXTRA "B+" PRODUCT"	STEEP "C"		PUMP* "D"
	TIME / VOLUME (SECONDS)/(ML)	TIME / WEIGHT (SECONDS)/(GR.)	TIME / WEIGHT (SECONDS)/(GR.)	NORMAL TIME "C" (SECONDS)"	EXTRA TIME "C+" (SECONDS)"	TIME (SECONDS)
FRESH BREW COFFEE AND FRESH BREW DECAF						
5 oz	4.50 / 130	1.40 / 5.00	1.40 / 5.00	3.00	5.00	12.00
7 oz	6.40 / 190	2.00 / 7.10	2.00 / 7.10	3.00	5.00	15.00
8 oz	7.50 / 220	2.30 / 8.20	2.30 / 8.20	3.00	5.00	17.00
9 oz	8.20 / 240	2.50 / 8.90	2.50 / 8.90	3.00	5.00	19.00
10 oz	9.00 / 265	2.80 / 10.00	2.80 / 10.00	3.00	5.00	22.00
12 oz	11.00 / 315	3.40 / 12.10	3.40 / 12.10	3.00	5.00	26.00
FRESH BREW ESPRESSO						
5 oz	2.25 / 65	1.40 / 5.00	1.40 / 5.00	3.00	5.00	9.00
7 oz	3.20 / 95	2.00 / 7.10	2.00 / 7.10	3.00	5.00	11.00
8 oz	3.75 / 110	2.30 / 8.20	2.30 / 8.20	3.00	5.00	12.00
9 oz	4.10 / 120	2.50 / 8.90	2.50 / 8.90	3.00	5.00	13.00
10 oz	4.50 / 130	2.80 / 10.00	2.80 / 10.00	3.00	5.00	14.00
12 oz	5.50 / 158	3.40 / 12.10	3.40 / 12.10	3.00	5.00	15.00

* If the programmed pump time is less than twice the water time, the pump time will default to 32 seconds.

FREEZE DRY DRINKS

CUP SIZE	WATER		PRODUCT	
	TIME/VOLUME "A" (SECONDS/ML)	NORMAL TIME/WEIGHT "B" (SECONDS/GRAMS)	EXTRA TIME/WEIGHT "B" (SECONDS/GRAMS)	
FREEZE DRY COFFEE				
5 oz	4.95 / 120	0.35 / 0.90	0.65 / 1.10	
7 oz	7.00 / 170	0.50 / 1.20	0.90 / 1.50	
8 oz	8.25 / 200	0.60 / 1.50	1.10 / 1.80	
9 oz	8.65 / 210	0.65 / 1.60	1.20 / 2.00	
10 oz	7.90 / 240	0.70 / 1.80	1.35 / 2.20	
12 oz	12.60 / 305	0.90 / 2.20	1.60 / 2.60	
FREEZE DRY DECAF				
5 oz	4.95 / 120	0.35 / 0.90	0.65 / 1.10	
7 oz	7.00 / 170	0.50 / 1.20	0.90 / 1.50	
8 oz	8.25 / 200	0.60 / 1.50	1.10 / 1.80	
9 oz	8.65 / 210	0.65 / 1.60	1.20 / 2.00	
10 oz	7.90 / 240	0.70 / 1.80	1.35 / 2.20	
12 oz	12.60 / 305	0.90 / 2.20	1.60 / 2.60	
FREEZE DRY ESPRESSO				
5 oz	2.50 / 60	0.35 / 0.90	0.65 / 1.10	
7 oz	3.50 / 85	0.50 / 1.20	0.90 / 1.50	
8 oz	4.15 / 100	0.60 / 1.50	1.10 / 1.80	
9 oz	4.35 / 105	0.65 / 1.60	1.20 / 2.00	
10 oz	4.95 / 120	0.70 / 1.80	1.35 / 2.20	
12 oz	6.30 / 153	0.90 / 2.20	1.60 / 2.60	

CHOCOLATE DRINKS

CUP SIZE	WATER "A"	PRODUCT "B"	PRODUCT "B+"
	TIME / VOLUME (SECONDS)/(ML.)	NORMAL TIME / WEIGHT (SECONDS)/(GR.)	EXTRA TIME / WEIGHT (SECONDS)/(GR.)
5 oz	4.85 / 100	2.80 / 17.00	2.80 / 17.00
7 oz	6.80 / 160	4.00 / 24.00	4.00 / 24.00
8 oz	8.25 / 170	4.65 / 28.00	4.65 / 28.00
9 oz	8.75 / 180	5.15 / 31.00	5.15 / 31.00
10 oz	9.70 / 200	5.65 / 34.00	5.65 / 34.00
12 oz	11.65 / 240	6.80 / 41.00	6.80 / 41.00

HOT WATER ONLY

CUP SIZE	TIME / VOLUME "A"
	(SECONDS)/(ML.)
5 oz	4.85 / 100
7 oz	6.80 / 160
8 oz	8.25 / 170
9 oz	8.75 / 180
10 oz	9.70 / 200
12 oz	11.65 / 240

"INTERNATIONAL COFFEE" - SOLUBLE PRODUCT

This International Coffee - Soluble Product table contains factory recommended times. These are not pre-programmed "default" times as for other selections, but will give you a starting point to manually enter your International Coffee - Soluble Product dispense times.

CUP SIZE	WATER "A"	PRODUCT "B"	PRODUCT "B+"
	TIME / VOLUME (SECONDS)/(ML.)	NORMAL TIME / WEIGHT (SECONDS)/(GRAMS)	EXTRA TIME / WEIGHT (SECONDS)/(GRAMS)
5 oz	4.85 / 110	2.45 / 10.00	2.45 / 10.00
7 oz	6.80 / 150	3.35 / 13.50	3.35 / 13.50
8 oz	8.25 / 180	4.00 / 16.20	4.00 / 16.20
9 oz	8.75 / 195	4.35 / 17.80	4.35 / 17.80
10 oz	9.70 / 215	4.85 / 19.70	4.85 / 19.70
12 oz	11.65 / 260	5.80 / 23.70	5.80 / 23.70

The following tables are for drinks that use whitener. These drinks are only available in machines configured with the whitener option.

FRESH BREW DRINKS WITH WHITENER

CUP SIZE	"A" WATER	NORMAL "B" PRODUCT	EXTRA "B+" PRODUCT	STEEP "C"		PUMP* "D"	"E" WHITENER PRODUCT
	TIME / VOLUME (SECONDS)/(ML.)	TIME / WEIGHT (SECONDS)/(GR.)	TIME / WEIGHT (SECONDS)/(GR.)	NORMAL TIME "C" (SECONDS)	EXTRA TIME "C+" (SECONDS)	TIME (SECONDS)	TIME / WEIGHT (SECONDS)/(GR.)
FRESH BREW COFFEE AND FRESH BREW DECAF WITH WHITENER							
5 oz	3.60 / 105	1.40 / 5.00	1.40 / 5.00	3.00	5.00	12.00	0.15 / 0.25
7 oz	5.10 / 150	2.00 / 7.10	2.00 / 7.10	3.00	5.00	15.00	0.20 / 0.35
8 oz	6.00 / 175	2.30 / 8.20	2.30 / 8.20	3.00	5.00	17.00	0.25 / 0.45
9 oz	7.05 / 205	2.50 / 8.90	2.50 / 8.90	3.00	5.00	19.00	0.30 / 0.50
10 oz	7.75 / 225	2.80 / 10.00	2.80 / 10.00	3.00	5.00	22.00	0.35 / 0.60
12 oz	9.45 / 280	3.40 / 12.10	3.40 / 12.10	3.00	5.00	26.00	0.40 / 0.70
FRESH BREW ESPRESSO WITH WHITENER							
5 oz	1.05 / 30	1.40 / 5.00	1.40 / 5.00	3.00	5.00	9.00	0.10 / 0.15
7 oz	1.80 / 50	2.00 / 7.10	2.00 / 7.10	3.00	5.00	11.00	0.10 / 0.15
8 oz	2.25 / 65	2.30 / 8.20	2.30 / 8.20	3.00	5.00	12.00	0.15 / 0.25
9 oz	2.80 / 80	2.50 / 8.90	2.50 / 8.90	3.00	5.00	13.00	0.15 / 0.25
10 oz	3.15 / 90	2.80 / 10.00	2.80 / 10.00	3.00	5.00	14.00	0.20 / 0.35
12 oz	4.00 / 115	3.40 / 12.10	3.40 / 12.10	3.00	5.00	15.00	0.20 / 0.35

FRESH BREW RECIPE DRINKS

CUP SIZE	"A" WATER	NORMAL "B" PRODUCT	EXTRA "B+" PRODUCT	STEEP "C"		PUMP* "D"	"E" WHITENER PRODUCT	SECOND PRODUCT "F"	EXTRA SECOND PRODUCT "F+"
	TIME / VOL. (SEC.)/(ML.)	TIME / WEIGHT (SEC.)/(GR.)	TIME / WEIGHT (SEC.)/(GR.)	NORMAL TIME "C+" (SECONDS) "	EXTRA TIME "C+" (SECONDS) "	TIME (SECONDS)	TIME / WEIGHT (SEC.)/(GR.)	TIME / WEIGHT (SEC.)/(GR.)	TIME / WEIGHT (SEC.)/(GR.)
FRESH BREW CAFE' MOCHA									
5 oz	0.55 / 15	1.40 / 5.00	1.40 / 5.00	3.00	5.00	9.00	0.20 / 0.35	0.85 / 5.25	0.85 / 5.25
7 oz	1.15 / 35	2.00 / 7.10	2.00 / 7.10	3.00	5.00	11.00	0.30 / 0.50	1.20 / 7.25	1.20 / 7.25
8 oz	2.85 / 85	2.30 / 8.20	2.30 / 8.20	3.00	5.00	12.00	0.35 / 0.60	1.35 / 8.25	1.35 / 8.25
9 oz	3.15 / 95	2.50 / 8.90	2.50 / 8.90	3.00	5.00	13.00	0.40 / 0.70	1.55 / 9.25	1.55 / 9.25
10 oz	4.00 / 115	2.80 / 10.00	2.80 / 10.00	3.00	5.00	14.00	0.45 / 0.80	1.70 / 10.25	1.70 / 10.25
12 oz	5.55 / 165	3.40 / 12.10	3.40 / 12.10	3.00	5.00	15.00	0.50 / 0.90	2.00 / 12.25	2.00 / 12.25
FRESH BREW CAPPUCCINO AND CAFFÈ LATTE									
5 oz	2.65 / 75	1.40 / 5.00	1.40 / 5.00	3.00	5.00	9.00	0.45 / 0.80		
7 oz	4.30 / 125	2.00 / 7.10	2.00 / 7.10	3.00	5.00	12.00	0.65 / 1.15		
8 oz	5.40 / 160	2.30 / 8.20	2.30 / 8.20	3.00	5.00	14.00	0.75 / 1.30		
9 oz	5.85 / 170	2.50 / 8.90	2.50 / 8.90	3.00	5.00	15.00	0.85 / 1.50		
10 oz	6.75 / 200	2.80 / 10.00	2.80 / 10.00	3.00	5.00	16.00	0.95 / 1.65		
12 oz	8.55 / 250	3.40 / 12.10	3.40 / 12.10	3.00	5.00	20.00	1.10 / 1.90		

* If the programmed pump time is less than twice the water time, the pump time will default to 32 seconds.

FREEZE DRY DRINKS WITH WHITENER

CUP SIZE	WATER	PRODUCT		"E" WHITENER PRODUCT"
	TIME/VOLUME "A" (SECONDS)/(ML.)	NORMAL TIME/WEIGHT "B" (SECONDS)/(GRAMS)	EXTRA TIME/WEIGHT "B+" (SECONDS)/(GRAMS)	NORMAL TIME/WEIGHT "E" (SECONDS)/(GRAMS)
FREEZE DRY COFFEE WITH WHITENER				
5 oz	3.70 / 90	0.35 / 0.90	0.65 / 1.10	0.15 / 0.25
7 oz	5.15 / 125	0.50 / 1.20	0.90 / 1.50	0.20 / 0.35
8 oz	6.00 / 145	0.60 / 1.50	1.10 / 1.80	0.25 / 0.45
9 oz	6.60 / 160	0.65 / 1.60	1.20 / 2.00	0.30 / 0.50
10 oz	7.65 / 185	0.70 / 1.80	1.35 / 2.20	0.35 / 0.60
12 oz	9.70 / 235	0.90 / 2.20	1.60 / 2.60	0.40 / 0.70
FREEZE DRY DECAF WITH WHITENER				
5 oz	3.70 / 90	0.35 / 0.90	0.65 / 1.10	0.15 / 0.25
7 oz	5.15 / 125	0.50 / 1.20	0.90 / 1.50	0.20 / 0.35
8 oz	6.00 / 145	0.60 / 1.50	1.10 / 1.80	0.25 / 0.45
9 oz	6.60 / 160	0.65 / 1.60	1.20 / 2.00	0.30 / 0.50
10 oz	7.65 / 185	0.70 / 1.80	1.35 / 2.20	0.35 / 0.60
12 oz	9.70 / 235	0.90 / 2.20	1.60 / 2.60	0.40 / 0.70
FREEZE DRY ESPRESSO WITH WHITENER				
5 oz	1.45 / 35	0.35 / 0.90	0.65 / 1.10	0.10 / 0.15
7 oz	2.05 / 50	0.50 / 1.20	0.90 / 1.50	0.10 / 0.15
8 oz	2.50 / 60	0.60 / 1.50	1.10 / 1.80	0.15 / 0.25
9 oz	2.90 / 70	0.65 / 1.60	1.20 / 2.00	0.15 / 0.25
10 oz	3.30 / 80	0.70 / 1.80	1.35 / 2.20	0.20 / 0.35
12 oz	4.55 / 110	0.90 / 2.20	1.60 / 2.60	0.20 / 0.35

FREEZE DRY RECIPE DRINKS

CUP SIZE	"A" WATER	NORMAL "B" PRODUCT	EXTRA "B+" PRODUCT	"E" WHITENER PRODUCT	SECOND PRODUCT "F"	EXTRA SECOND PRODUCT "F+"
	TIME / VOL. (SEC.)/(ML.)	TIME/WEIGHT (SEC.)/(GR.)	TIME/WEIGHT (SEC.)/(GR.)	TIME/WEIGHT (SEC.)/(GR.)	TIME/WEIGHT (SEC.)/(GR.)	TIME/WEIGHT (SEC.)/(GR.)
FREEZE DRY CAFE' MOCHA						
* 5 oz	0.00 / 00	0.00 / 00	0.00 / 00	0.00 / 00	0.00 / 00	0.00 / 00
7 oz	2.05 / 50	0.50 / 1.20	0.90 / 1.50	0.30 / 0.50	1.20 / 7.25	1.20 / 7.25
8 oz	3.10 / 75	0.60 / 1.50	1.10 / 1.80	0.35 / 0.60	1.35 / 8.25	1.35 / 8.25
9 oz	3.30 / 80	0.65 / 1.60	1.20 / 2.00	0.40 / 0.70	1.55 / 9.25	1.55 / 9.25
10 oz	4.55 / 110	0.70 / 1.80	1.35 / 2.20	0.45 / 0.80	1.70 / 10.25	1.70 / 10.25
12 oz	6.40 / 155	0.90 / 2.20	1.60 / 2.60	0.50 / 0.90	2.00 / 12.25	2.00 / 12.25
FREEZE DRY CAPPUCCINO AND CAFFÈ LATTE						
5 oz	2.90 / 70	0.35 / 0.90	0.65 / 1.05	0.45 / 0.80		
7 oz	4.75 / 115	0.50 / 1.20	0.90 / 1.50	0.65 / 1.15		
8 oz	6.00 / 145	0.60 / 1.50	1.10 / 1.80	0.75 / 1.30		
9 oz	6.20 / 150	0.65 / 1.60	1.20 / 2.00	0.85 / 1.50		
10 oz	7.40 / 180	0.70 / 1.80	1.35 / 2.20	0.95 / 1.65		
12 oz	9.90 / 240	0.90 / 2.20	1.60 / 2.60	1.10 / 1.90		

* Cafe' mocha is not recommended for this drink size. Insufficient water is dispensed to properly rinse the mixing bowls.

HOT WHITENER

CUP SIZE	WATER "A"	PRODUCT "B"		PRODUCT "B+"
	TIME / VOLUME (SECONDS)/(ML.)	NORMAL TIME / WEIGHT (SECONDS)/(GRAMS)	EXTRA TIME / WEIGHT (SECONDS)/(GRAMS)	
5 oz	4.95 / 110	0.70 / 1.20		0.70 / 1.20
7 oz	7.00 / 150	1.00 / 1.75		1.00 / 1.75
8 oz	8.25 / 180	1.15 / 2.00		1.15 / 2.00
9 oz	8.65 / 195	1.30 / 2.25		1.30 / 2.25
10 oz	9.90 / 215	1.45 / 2.50		1.45 / 2.50
12 oz	12.60 / 260	1.70 / 3.00		1.70 / 3.00